



## C2616, C2415 Installation Instructions 2007-2013 Chevy 1/2 Ton 2wd Pickup 4.5", 6.5" Suspension System

### Read and understand all instructions and warnings prior to installation of product and operation of vehicle.

Zone Offroad Products recommends this system be installed by a professional technician. In addition to these instructions, professional knowledge of disassembly/ reassembly procedures and post installation checks must be known. Minimum tool requirements include the following: Assorted metric and standard wrenches, hammer, hydraulic floor jack and a set of jack stands. See the "Special Tools Required" section for additional tools needed to complete this installation properly and safely.

#### »» PRODUCT SAFETY WARNING

Certain Zone Suspension Products are intended to improve off-road performance. Modifying your vehicle for off-road use may result in the vehicle handling differently than a factory equipped vehicle. Extreme care must be used to prevent loss of control or vehicle rollover. Failure to drive your modified vehicle safely may result in serious injury or death. Zone Offroad Products does not recommend the combined use of suspension lifts, body lifts, or other lifting devices.

You should never operate your modified vehicle under the influence of alcohol or drugs. Always drive your modified vehicle at reduced speeds to ensure your ability to control your vehicle under all driving conditions. Always wear your seat belt.

#### »» TECHNICAL SUPPORT

*Live Chat* provides instant communication with Zone tech support. Anyone can access live chat through a link on [www.zoneoffroad.com](http://www.zoneoffroad.com).

[www.zoneoffroad.com](http://www.zoneoffroad.com) may have additional information about this product including the latest instructions, videos, photos, etc.

Send an e-mail to [tech@zoneoffroad.com](mailto:tech@zoneoffroad.com) detailing your issue for a quick response.

**888.998.ZONE** Call to speak directly with Zone tech support.

#### »» PRE-INSTALLATION NOTES

1. Special literature required: OE Service Manual for model/year of vehicle. Refer to manual for proper disassembly/reassembly procedures of OE and related components.
2. Adhere to recommendations when replacement fasteners, retainers and keepers are called out in the OE manual.
3. Larger rim and tire combinations may increase leverage on suspension, steering, and related components. When selecting combinations larger than OE, consider the additional stress you could be inducing on the OE and related components.
4. Post suspension system vehicles may experience drive line vibrations. Angles may require tuning, slider on shaft may require replacement, shafts may need to be lengthened or trued, and U-joints may need to be replaced.
5. Secure and properly block vehicle prior to installation of Zone Offroad Products. Always wear safety glasses when using power tools.
6. If installation is to be performed without a hoist, Zone Offroad Products recommends rear alterations first.
7. Due to payload options and initial ride height variances, the amount of lift is a base figure. Final ride height dimensions may vary in accordance to original vehicle attitude. Always measure the attitude prior to beginning installation.

#### Difficulty Level

easy 1 2 3 **4** 5 difficult

Estimated installation: 5-6 hours

#### Special Tools Required

#### Tire/Wheel Fitment

##### 6.5" Lift:

35 x 12.50 on 17x9, 18x9 w/ 5" BS

35 x 12.50 on 20x9 w/ 5.75" BS

33 x 12.50 on 17x8 w/ 4.5" BS

##### 4.5" Lift:

33 x 12.50 on 17x9, 18x9 w/ 5" BS

33 x 12.50 on 20x9 w/ 5.75" BS

32 x 11.50 on 17x8 w/ 4.5" BS

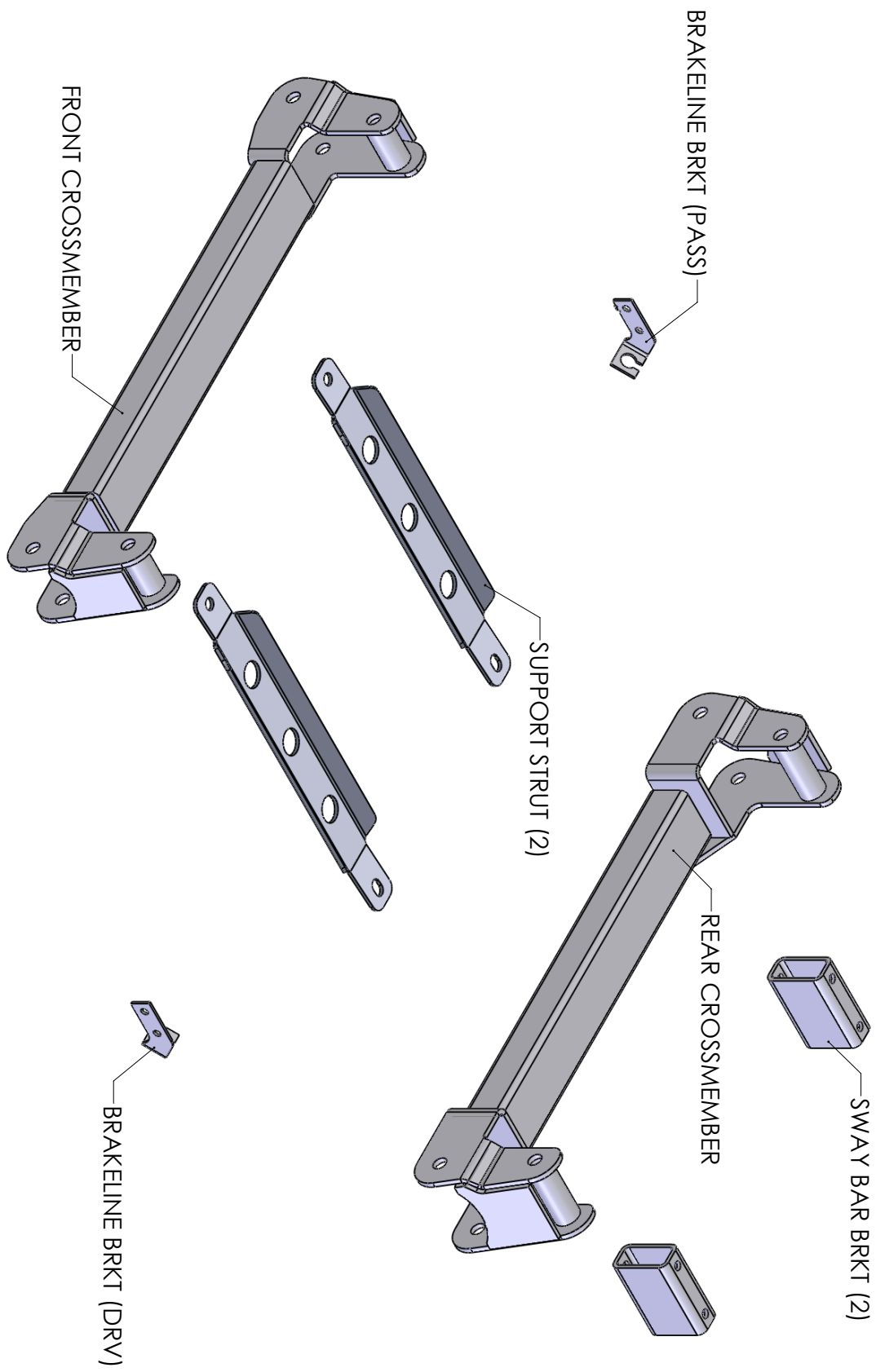

**\*Important\* Verify you have all of the kit components before beginning installation.**

## Kit Contents

### Box Kit ZONC2415

Qty	Part
1	Bag Kit: GM 1500 4.5" Kit
1	Thread Locker
1	Bolt Pack: 10mm Strut Spacer
1	Bolt Pack - 4x - 9/16 U-Bolt
1	Front Crossmember - black
1	Rear Crossmember - black
2	Sway Bar Spacer - black
2	Crossmember Brace - black
2	4" Block
4	9/16 x 2-9/16 x 11-3/8 Square U-Bolt
2	Strut Spacer
6	Hardware: M10-1.50 X 35MM HEX CAP 18-8 Bolt

### Box Kit ZONC2616

Qty	Part
1	Bag Kit: GM 1500 6.5" Kit
1	Thread Locker
1	Bolt Pack: 10mm Strut Spacer
1	Bolt Pack - 4x - 9/16 U-Bolt
1	Front Crossmember - black
1	Rear Crossmember - black
2	Sway Bar Spacer - black
2	Crossmember Brace - black
2	5" Flat Block
4	9/16" x 2-1/2" x 14 Square U-Bolt
2	Strut Spacer

## IMPORTANT

It is required that ride height measurements be taken before and after installation. Measure from the **WHEEL AXLE CENTER** up to the **FENDER LIP** of the wheel opening. Do this for all 4 wheels. Record measurements below.\*\*

### BEFORE:

LF \_\_\_\_\_ RF \_\_\_\_\_ LR \_\_\_\_\_ RR \_\_\_\_\_

### AFTER:

LF \_\_\_\_\_ RF \_\_\_\_\_ LR \_\_\_\_\_ RR \_\_\_\_\_



**\*\*These ride heights will be required if you have any ride height concerns after installation. Please be prepared to provide these to Technical Support.**

## INSTALLATION INSTRUCTIONS

### » FRONT INSTALLATION

1. Park the vehicle on a clean, flat surface and block the rear wheels for safety.
2. Disconnect the positive and negative battery cables from the battery.
3. Raise the front of the vehicle with a hydraulic jack and support the frame with jack stands just behind the rear lower control arm pocket.
4. Remove the wheels.
5. Disconnect the ABS line from the connector on the frame **Figure 1**. Remove the ABS line from the retaining clips at the frame, upper control arm and knuckle.
6. Disconnect the brake line bracket from the upper control arm **Figure 1**. Save bolt.



Figure 1

7. Disconnect the steering from the knuckle **Figure 2**. Remove the tie rod end nut. Strike the knuckle near the tie rod end with a hammer to dislodge it. Save the mounting nut.

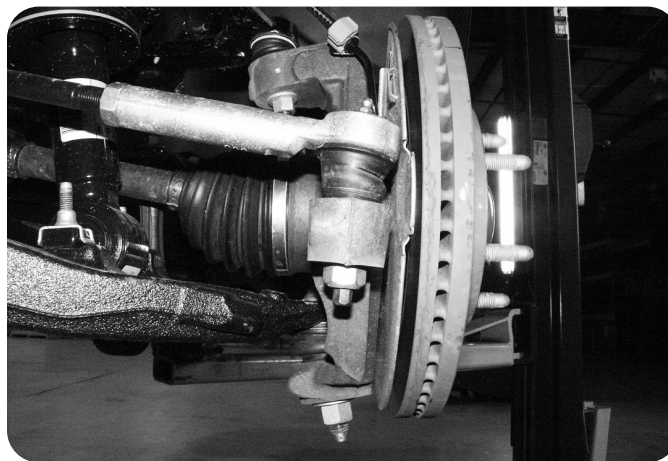

Figure 2

8. Remove the two brake caliper mount bolts and remove the caliper assembly from the knuckle **Figure 3**. Hang the caliper securely out of the way. **DO NOT** hang the caliper by the brake hose. Save caliper bolts.

### Step 7 Note

Do not strike the tie rod end with the hammer, only the knuckle.





Figure 3

9. Remove the sway bar links from the sway bar and the lower control arm **Figure 4A**. Save the links, bushings and hardware.
10. Remove the sway bar from the frame by removing the four bushing cap mounting bolts **Figure 4B**. Save all sway bar components.
11. Mark each of the front strut bodies to indicate driver's versus passenger's side. Make the marks on the side of the strut that is facing out.
12. Support the lower control arm with a jack. Remove the lower strut mount bolts **Figure 4C**. Save bolts.

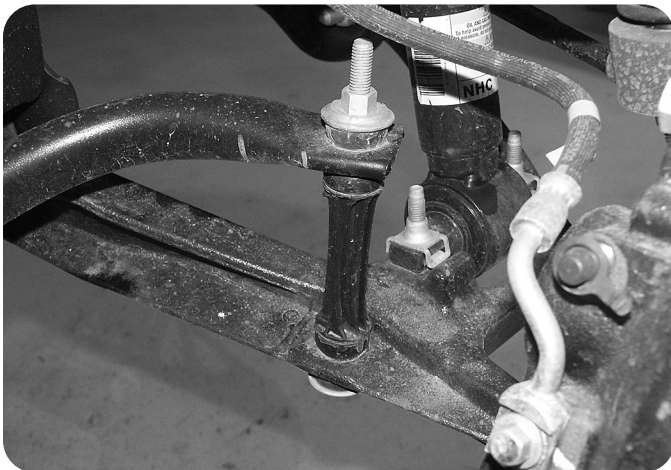

Figure 4A



Figure 4B



Figure 4C

### Step 14 Note

Do not strike the ball joints only the knuckle.

13. Remove the upper and lower ball joint nuts and thread back on by hand a couple of turns. Strike the knuckle near the upper and lower ball joints to dislodge them from the knuckle. Remove the upper ball joint nut and lower the lower control arm down. Remove the lower ball joint nut and remove the knuckle assembly from the lower control arm. Save ball joint nuts.
14. Remove the three upper strut mounting nuts **Figure 5** and remove the strut from the vehicle. **DO NOT** remove the center strut rod nut, it is under extreme pressure. Save nuts.

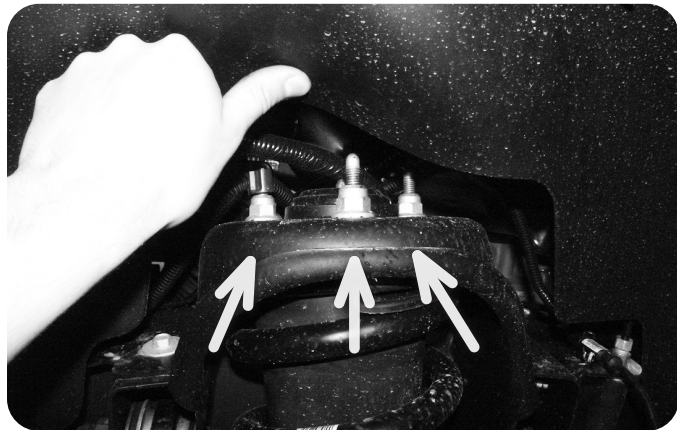

Figure 5

15. Remove the front and rear lower control arm mounting bolts and remove the lower control arm from the vehicle. Save mounting hardware and control arms.
16. Install the new rear crossmember with the factory lower control arm bolts, nuts and washers. When installed the rectangular cross tube should offset closer to the rear of the vehicle **Figure 8**. Run the bolts from front to rear. Leave hardware loose.
17. Install the front crossmember in the control arm pockets with the factory lower control arm bolts, nuts and washers. When installed the offset in the crossmember ends should be toward the front of the vehicle **Figure 6**. Run bolts from front to rear. Leave hardware loose.

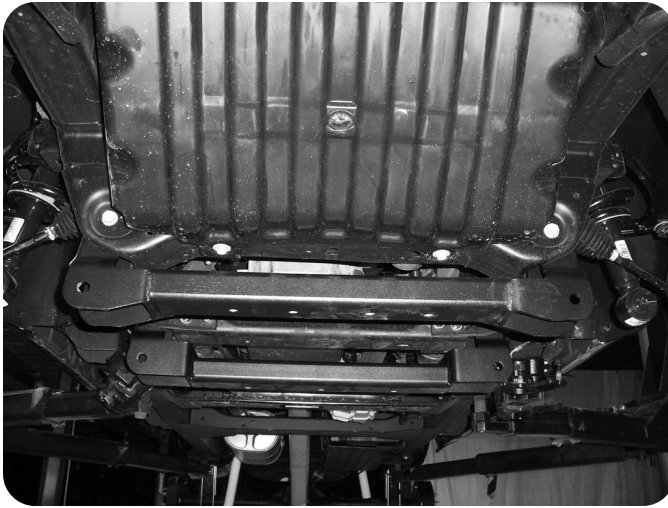

Figure 6

18. Attach the provided crossmember support struts to the front and rear crossmembers with 1/2" x 1-1/4" bolts and 1/2" SAE washers in the outer threaded holes in the front crossmember and 1/2" x 3" bolts, nuts and washer through the holes in the rear crossmember. The ends of the support strut are bent to set flush with the bottoms of the crossmembers **Figure 7**. There will be one thread hole left in the center of the front crossmember. Install the remaining 1/2" bolt and washer in this hole. Use Loctite on the bolts. Leave hardware loose.

### Step 19 Note

Hardware for the crossmember support struts is located in hardware pack #643.

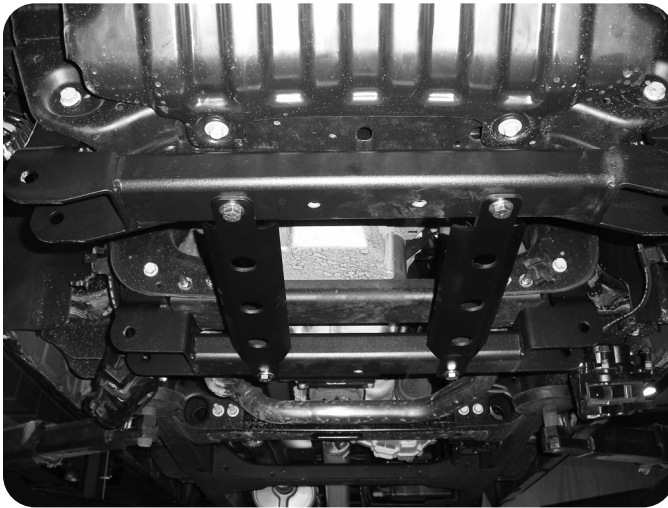

Figure 7

19. Install the OE lower control arms in the new crossmembers and fasten with 5/8" x 4-1/2" (front) and 5/8" x 5-1/2" (rear) bolts, nuts and 5/8" SAE washers. Run the bolts from front to rear. Leave hardware loose.
20. With the crossmembers, control arms, skid plate and support strut installed, go back and torque the crossmember mounting bolts to 125 ft-lbs and the skid plate/support strut hardware to 65 ft-lbs.

### Step 20 Note

Hardware for the lower control arms is located in hardware pack #621.

## » 4" AND 6" STRUT SPACER ASSEMBLY

21. Install the provided strut spacers on the struts with provided nuts and washers. The spacers will only install one way. Torque the hardware to 30 ft-lbs. **Figure 8**

### Step 22 Note

Hardware for the strut spacers is located in bolt pack 629.



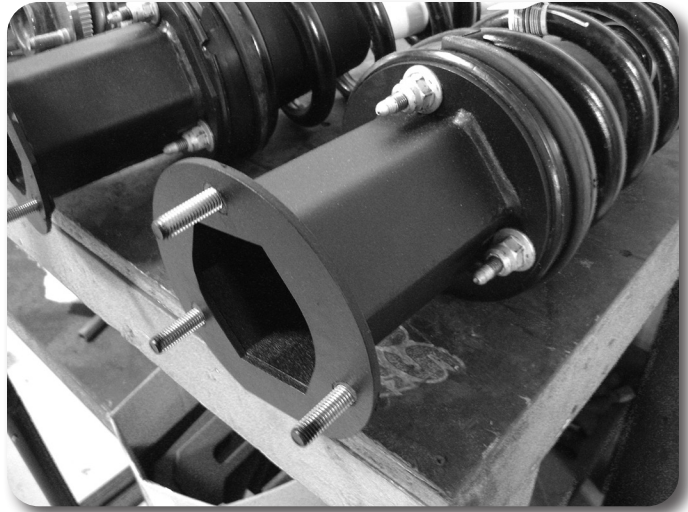

Figure 8

22. Install the new strut assembly to the appropriate frame mount with the factory flange nuts. Leave hardware loose.
23. Swing the lower control arm up to the strut and fasten it with the original mounting bolts. Torque lower and upper strut hardware to 40 ft-lbs.
24. Remove the hub bearing/rotor assembly and brake dust shield from the factory steering knuckles. Be sure to note which hub goes on which side of the vehicle. Save mounting bolts.
25. The brake dust shield needs to be trimmed. Measure in from the lower vertical edge (opposite the ABS sensor location)  $\frac{3}{4}$ " and make a vertical cut line along the entire flat section **Figure 9**. Cut the mark section off of the brake dust shield.

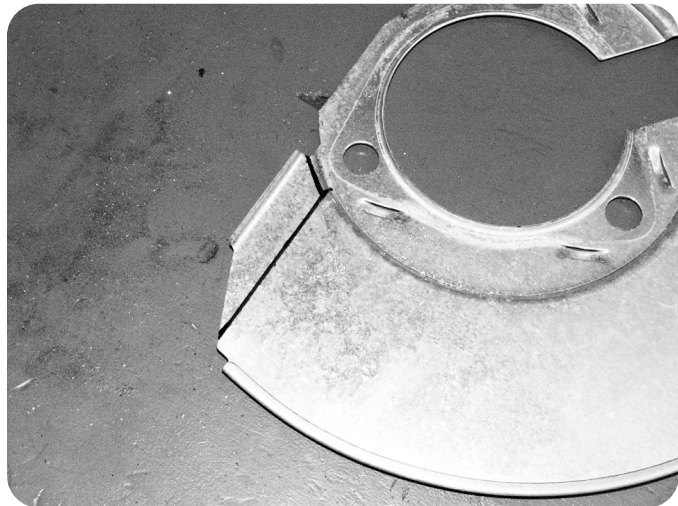

Figure 9

26. Install the modified dust shield and hub/rotor in the corresponding new knuckles. Fasten the hub/shield with the OE bolts. Apply Loctite to the bolt threads and torque to 133 ft-lbs. Be sure that the ABS line is run properly through the dust shield and out above the steering arm on the knuckle.
27. Install the assembled knuckle on the lower control arm with the original lower ball joint nut. Attach the knuckle to the upper control arm with the original upper ball joint nut. Torque the upper ball joint nut to 37 ft-lbs and the lower ball joint nut to 74 ft-lbs **Figure 10**.

### Step 28 Note

To make connecting the upper ball joint easier, loosen the upper control arm cam bolts at the frame and rotate the cams to shift the control arm outward.

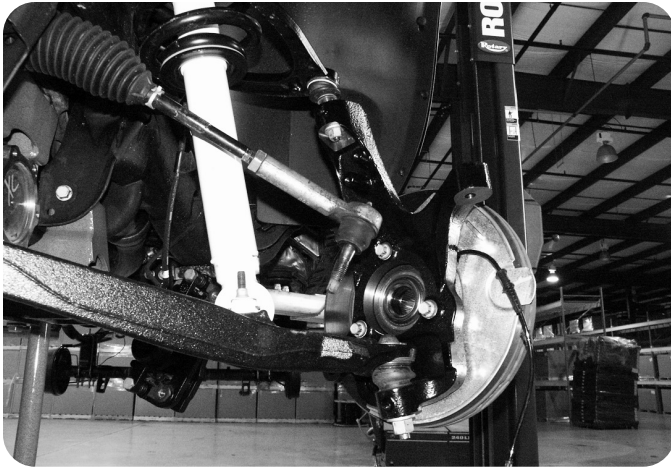

Figure 10

28. Working on one side at a time, remove the tie rod end from the steering link **Figure 11**. Trim 3/8" off of both the tie rod end and the steering link **Figure 12, 13**. This will allow for proper alignment adjustment once the kit is complete. Once the two pieces are trimmed, clean the ends of the threads and reinstall the tie rod end on the steering link. Repeat on other side of the vehicle.

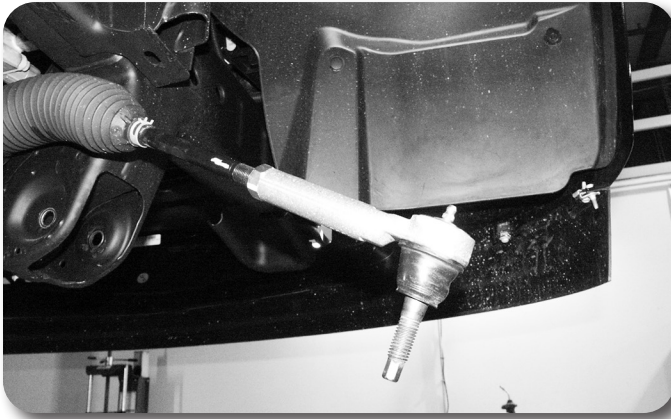

Figure 11

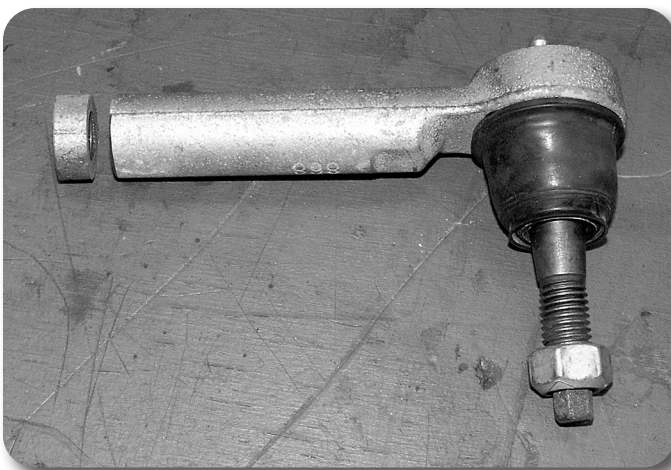

Figure 12





Figure 13

29. Disconnect the factory rubber brake line from the hard line at the frame. Remove the retaining clip and remove the brake line from the bracket. Disconnect the bracket from the frame. Save hardware.
30. Attach the caliper to the new steering knuckle with the original mounting hardware. Torque bolts to 125 ft-lbs.
31. Carefully remove the metal retainer bracket from the factory rubber brake line.
32. Locate the threaded hole where the factory brake line bracket mounted. Measure out 1-3/8" on the upper control arm mount and mark. Drill a 5/16" hole at the mark Figure 14.

### Step 33 Note

It may be easier to remove the brake line from the bracket by removing it from the vehicle completely and holding the bracket in a bench vise.



Figure 14

33. Attach the provided brake line bracket to the upper control arm mount using the original mounting hole/hardware and the newly drilled hole/provided 5/16" x 3/4" bolt, nut, and washers. Figure 15 Leave hardware loose.

### Step 34 Note

Hardware for the brake line brackets is located in hardware pack #643.

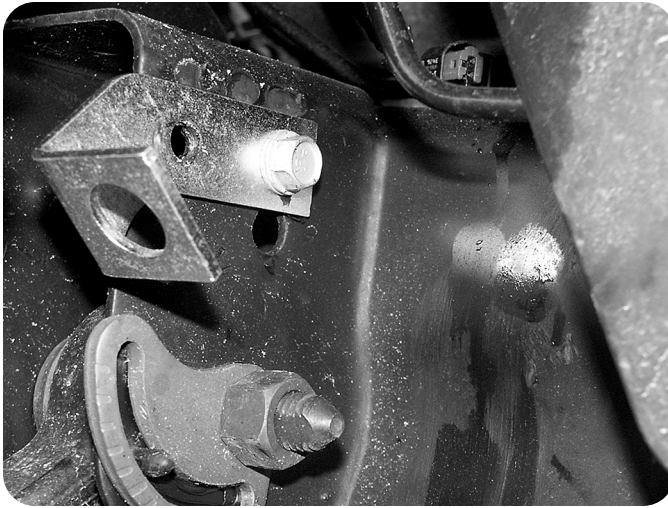

Figure 15

34. Carefully reform the brake hard line down near the new bracket. Run the end of the rubber brake hose through the bracket and attach it to the hard line. Tighten the fitting securely. Retain the brake line to the bracket with the original clip.
35. With the brake line installed go back and torque the new brake line bracket to 20 ft-lbs.
36. Attach the ABS line to the upper control arm with the original brake line mounting bolt and provided wire clamp Figure 16.



Figure 16

37. Reconnect ABS line at the frame. Attach the ABS line to the steering knuckle with the provided wire clamps and  $\frac{1}{4}$ " x  $\frac{3}{4}$ " bolt, flat washer and lock washer. Torque bolt to 15 ft-lbs. Use zip ties to retain the remaining section of the ABS line as needed to keep it away from rotating objects Figure 17.

### Step 38 Note

Hardware for the brake line clamps is located in hardware pack #643.



Figure 17

38. Locate the original sway bar link mounting hole on the lower control arm. Measure inward from the center on the hole 1-1/2" (toward the frame mount) and mark. Measure in from the back edge of the control near the first mark 3/4" and mark. Where the two marks cross drill a 5/8" hole Figure 18.
39. Attach the factory front sway bar to the original mounts in conjunction with the provided drop brackets and 10mm x 130mm bolts/washers. Use Loctite on the bolt threads and torque to 45 ft-lbs Figure 19.

### Step 40 Note

Hardware for the sway bar drops is located in hardware pack #643.

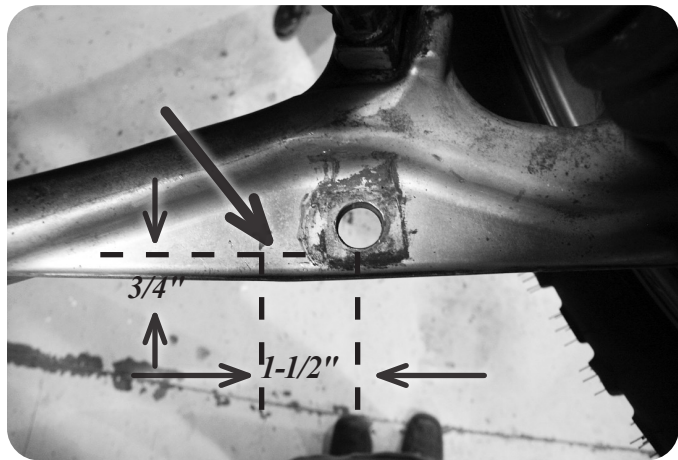

Figure 18

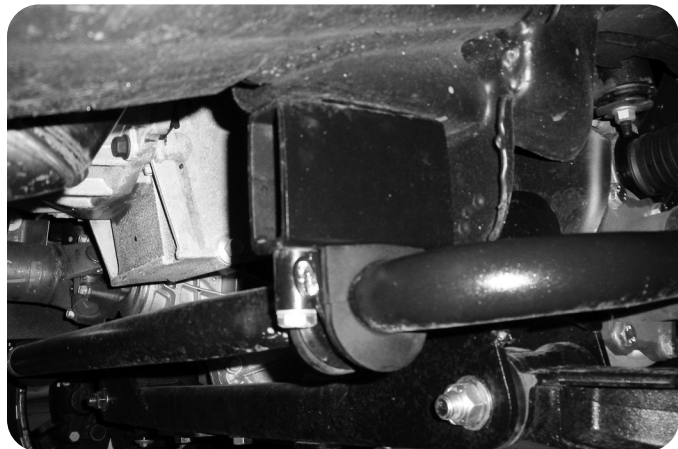

Figure 19

40. Attach the original sway bar links and hardware to the sway bar end and new hole in the lower control arm **Figure 20**. Tighten the sway bar link until the bushings begin to swell.



Figure 20

41. Connect the steering tie rod ends to the knuckles with the factory tie rod end nuts. Torque to 60 ft-lbs. Snug the tie rod end jam nuts securely. They will be adjusted during alignment.
42. Install the wheels/tires and lower the front of the vehicle to the ground. Torque lug nuts to 140 ft-lbs.
43. Bounce the front of the vehicle to settle the suspension. Torque the lower control arm mounting bolts to 150 ft-lbs. If the upper control arm cam bolts were loosened during the installation, center the cams and torque the bolts to 125 ft-lbs.
44. Check all hardware for proper torque.
45. Bleed the entire brake system. See service manual for proper brake system bleeding procedures.
46. Reconnect the battery cables to the battery.

---

## » REAR INSTALLATION

1. Block the front wheels. Safely raise the rear of the vehicle and support with jack stands just ahead of the front leaf spring frame mount.
2. Remove the wheels.
3. Support the rear axle with a floor jack.
4. Disconnect the rear brake line bracket from the top of the differential **Figure 21**. Save hardware.

### Step 4 Note

The bracket uses a captive bolt, meaning that it is loosely pressed into the bracket hole.



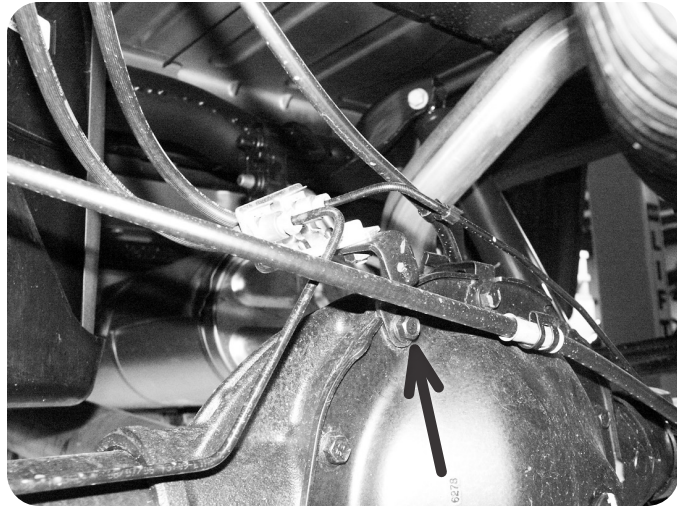

Figure 21

5. Remove the ABS lines from the retaining clip on the bottom of each frame rail. Also disconnect the ABS line connector from the top of the frame rail Figure 22.

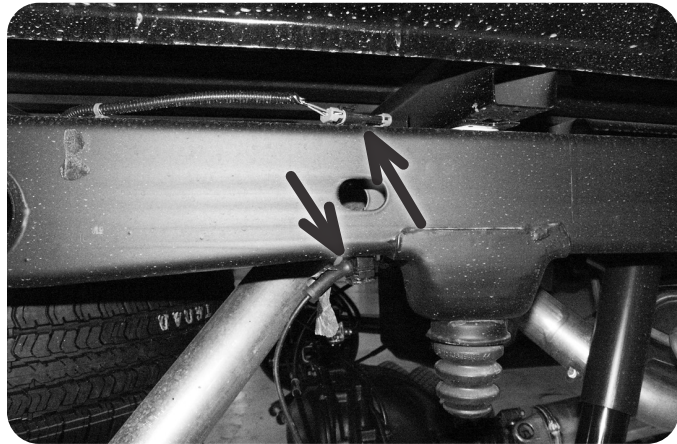

Figure 22

6. Remove the driver's side parking brake cable brackets from the driver's side frame rail Figure 23.



Figure 23



7. Support the center of the axle with a hydraulic jack. Remove the factory shocks from the axle and frame. Save hardware and discard shocks.
8. With the axle still well support remove the passenger's side u-bolts. The u-bolts will not be reused. Slowly lower the axle and remove the factory block from the axle. The factory block will not be reused.

*6.5" Lift ONLY: If installing the optional add-a-leaf kit #C6159, do so now following the instructions included in the kit. This portion of the installation should also be complete one side at time.*

9. Lower the axle just enough to install the new provided lift block between the axle and the spring. Align the pin in the block with the hole in the axle and the hole in the block with the leaf spring pin. It may be necessary to loosen the driver's side u-bolts slightly to allow the axle to lower far enough to install the block. On 4.5" kits, the block is tapered. Make sure the short end of the block goes toward the front of the vehicle.
10. Using the support jack, raise the axle so that the axle, spring and block are all touching. Install the new provided u-bolts, nuts and washers allow with the factory u-bolt plate **Figure 24**. Snug u-bolts but do not tighten.

### Step 9 Note

The hole in the factory axle mount may need to be clearanced slightly for proper pin fitment.



Figure 24

11. Repeat the installation on the driver's side of the vehicle. Pay special attention to all of the brake lines and wires. Do not allow them to get over-extended.
12. Remove the rear rubber bump stops from the frame **Figure 25**. Access the bolt head up through the center of bump stop. Install the provided 3" diameter x 3" tall spacer between the bump stop and the frame mount with a 10mm x 110mm Allen head bolt (Loctite threads). Center the spacer on the lip of the factory bump stop cup and torque bolt to 35 ft-lbs **Figure 26**.



Figure 25



Figure 26

13. Locate the new rear shocks. Install the provided bushings and steel sleeves into the eyes of the shocks. Lubricating the bushings and sleeves with some grease will make installation easier.
14. Install the new shocks with stock hardware and torque upper and lower bolts to 65 ft-lbs. The axle mounting tabs may need to be bent open slightly to allow for clearance of the larger diameter shocks. Also, check the clearance between the shock body and the brake line bolt (drv's side), this bolt may need to be trimmed.
15. Install the provided straight 3" brake line bracket to the top of the differential using factory mounting hole and bolt which must be removed from the factory brake line bracket. Attach the factory brake line bracket to the relocation bracket with a 5/16" x 1" bolt, nut and washers. Torque the factory and 5/16" bolt to 20 ft-lbs Figure 27.

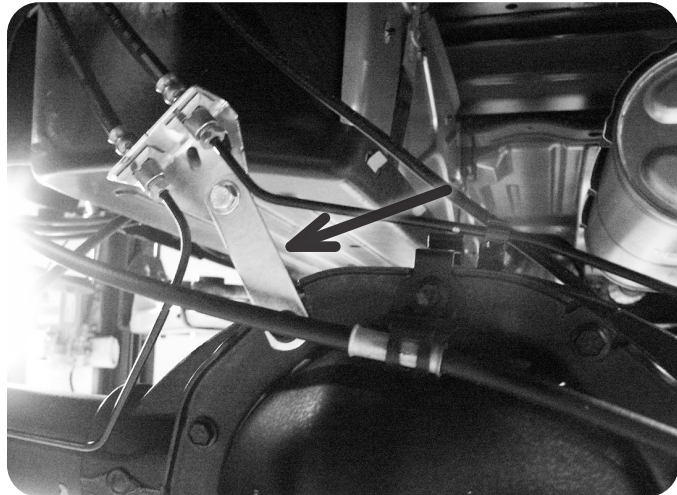

Figure 27

16. Reconnect the ABS lines to the plastic retaining clip at the bottom of each frame rail. The connector will not be reattached to the top of the frame. Reroute the lines as necessary to gain proper slack.
17. Reconnect the parking brake cable brackets to the driver's side frame rail with the original hardware. The driver's side cable will have to be removed from the rear bracket to gain appropriate slack. Torque bolts to 20 ft-lbs.

### Step 13 Note

Hardware for the bump stop spacers is located in hardware pack #628.

### Step 15 Note

Hardware for the brake line bracket is located in hardware pack #628.

### Step 16 Note

Be sure the ABS wire will not contact the exhaust.

18. Install wheels and tires. Torque lug nuts to 140 ft-lbs. Lower vehicle.
19. Bounce the rear of the vehicle to settle the suspension. Torque leaf spring u-bolts to 100-120 ft-lbs.

---

## » POST INSTALLATION

20. Double check all fasteners for proper torque.
21. Check all moving parts for clearance.
22. Complete a full radius turning check to ensure that no interference occurs.
23. Align headlights
24. Double check the brake lines for adequate slack at full wheel travel.
25. Complete a vehicle alignment.
26. Check all fasteners after 500 miles.

## Recommend Alignment Specifications

Caster

$2.20^{\circ} \pm 1.00^{\circ}$

## Post-Installation Warnings

1. Check all fasteners for proper torque. Check to ensure for adequate clearance between all rotating, mobile, fixed, and heated members. Verify clearance between exhaust and brake lines, fuel lines, fuel tank, floor boards and wiring harness. Check steering gear for clearance. Test and inspect brake system.
2. Perform steering sweep to ensure front brake hoses have adequate slack and do not contact any rotating, mobile or heated members. Inspect rear brake hoses at full extension for adequate slack. Failure to perform hose check/ replacement may result in component failure.
3. Perform head light check and adjustment.
4. Re-torque all fasteners after 500 miles. Always inspect fasteners and components during routine servicing.