

ZONE F2664 Installation Instructions **OFFROAD** 2021-2026 Ford F150 2WD 6" Suspension Systems

Read and understand all instructions and warnings prior to installation of product and operation of vehicle.

Zone Offroad Products recommends this system be installed by a professional technician. In addition to these instructions, professional knowledge of disassembly/ reassembly procedures and post installation checks must be known. Minimum tool requirements include the following: Assorted metric and standard wrenches, hammer, hydraulic floor jack and a set of jack stands. See the "Special Tools Required" section for additional tools needed to complete this installation properly and safely.

>> PRODUCT SAFETY WARNING

Certain Zone Suspension Products are intended to improve off-road performance. Modifying your vehicle for off-road use may result in the vehicle handling differently than a factory equipped vehicle. Extreme care must be used to prevent loss of control or vehicle rollover. Failure to drive your modified vehicle safely may result in serious injury or death. Zone Offroad Products does not recommend the combined use of suspension lifts, body lifts, or other lifting devices.

You should never operate your modified vehicle under the influence of alcohol or drugs. Always drive your modified vehicle at reduced speeds to ensure your ability to control your vehicle under all driving conditions. Always wear your seat belt.

>> TECHNICAL SUPPORT

www.zoneoffroad.com may have additional information about this product including the latest instructions, videos, photos, etc.

Send an e-mail to tech-zone@ridefox.com detailing your issue for a quick response.

888.998.ZONE Call to speak directly with Zone tech support.

>> PRE-INSTALLATION NOTES

1. Special literature required: OE Service Manual for model/year of vehicle. Refer to manual for proper disassembly/reassembly procedures of OE and related components.
2. Adhere to recommendations when replacement fasteners, retainers and keepers are called out in the OE manual.
3. Larger rim and tire combinations may increase leverage on suspension, steering, and related components. When selecting combinations larger than OE, consider the additional stress you could be inducing on the OE and related components.
4. Post suspension system vehicles may experience drive line vibrations. Angles may require tuning, slider on shaft may require replacement, shafts may need to be lengthened or trued, and U-joints may need to be replaced.
5. Secure and properly block vehicle prior to installation of Zone Offroad Products. Always wear safety glasses when using power tools.
6. If installation is to be performed without a hoist, Zone Offroad Products recommends rear alterations first.
7. Due to payload options and initial ride height variances, the amount of lift is a base figure. Final ride height dimensions may vary in accordance to original vehicle attitude. Always measure the attitude prior to beginning installation.

Difficulty Level

easy 1 2 3 **4** 5 difficult

Estimated installation: 8-10 hours

Special Tools Required

1-1/16" Socket/ wrench (18mm Bolts/Nuts)

Reciprocating saw or equivalent

Torque Wrench

Special Service Tool: 204-592 Separator

Tie Rod End Separator/Tire/Wheel Fitment

6" Lift:

35x12.50 on 18x9 or 20x9 and 4.5-5" BS

*37x12.50 on 20 x 9 and 5.5-5.75" BS

35x12.50 w/20 x 9 and 4.5-5.75" BS

*Trimming Is Required

Minor trimming may be required

See Pre-Installation Notes for more information

***Important* Verify you have all of the kit components before beginning installation.**

F2660- Knuckle Box - Drv

Qty	Description
1	Knuckle - Driver

F2661 Knuckle Box - Pass

Qty	Description
1	Knuckle - Passenger

F2664 Front Box Kit

Qty	Description
1	Front Crossmember
1	Rear Crossmember
2	Sway Bar Drop Brackets
2	Crossmember Brace
1	Front Brake Line Bracket - Driver
1	Front Brake Line Bracket - Passenger
8	Eccentric Cam Washer
4	Eccentric Cam Bolts
1	Thread Locker
4	"Oval Fir Tree" Cable Tie
4	Cable Tie
1	Bolt Pack - 407 - Sway Bar Drop Hardware
8	3/8" USS Washer, Yellow Zinc
4	7/16"-14 x 1-1/4" Bolt, Grade 8, Yellow Zinc
4	7/16"-14 Prevailing Torque Nut, Yellow Zinc
1	Bolt Pack - 773 - Front Hardware
2	18mm-2.50 x 150mm Bolt, Class 10.9, Clear Zinc
4	3/4" SAE Washer, Clear Zinc
2	18mm-2.50 Prevailing Torque Nut, Clear Zinc
2	1/4"-20 Prevailing Torque Nut, Clear Zinc
4	1/4" USS Washer, Clear Zinc
2	6mm-1.00 x 18mm Bolt, Class 8.8, Clear Zinc
4	1/2"-13 x 1-1/4" button head Bolt, Clear Zinc
4	1/2" SAE Washer, Clear Zinc
4	3/8"-16 x 1-1/4" Bolt, Grade 8, Yellow Zinc (Not Used)
8	3/8" SAE Washer, Yellow Zinc (Not Used)
4	3/8"-16 Prevailing Torque Nut, Yellow Zinc (Not Used)

F2604 Strut Spacer Box Kit

Qty	Description
2	Strut Spacer
1	Bolt Pack - 769 - Strut Spacer
6	7/16"-14 Nylock Nut, Clear Zinc
6	3/8" USS Washer, Clear Zinc
1	Bolt Pack 629 - Strut Spacer
6	10mm-1.50 Prevailing Torque Nut, Clear Zinc
6	3/8" USS Washer, Clear Zinc

F2417 3-1/4" Rear Box Kit

Qty	Description
2	3-1/4" Rear Block
1	9/16 x 3-1/8 x 12 Radiused Square U-bolt
2	Bump Stop Extension
1	Brake Line Bracket
1	Bolt Pack 896

Installation Instructions

»» PRE-INSTALLATION NOTES

1. Some trucks with a 2 piece drive shaft may have a recall from Ford regarding the rear drive shaft. (Safety Recall 21S25) Due to the recall procedure, Zone Offroad recommends to have this performed prior to installing the lift.”
2. 18" or larger diameter wheels required. Stock 17" and 18" wheels cannot be re-installed. Stock 20" wheels can be used with up to a 305/60R20 tire.
3. 18" wheels with 5-5.5" backspacing should be test fit prior to mounting the tire to ensure proper clearance to the steering knuckle/tie rod. 18 - 20" wheels with 5.5-5.75" of backspacing is highly recommended for tire to frame crash bar clearance. 37" tires will require crash bar modification
4. Models with 2-piece rear driveshaft WILL require carrier bearing shim kit D5405 (not included w/ kit).
5. Block kits replace factory 1-1/4" block. Stock block will not be reinstalled.
6. Crash bars may require modification based on wheel and tire choice. It is the end users responsibility to ensure modifications are non-detrimental to vehicle safety.
7. Does not fit diesel models.
8. Does not fit Tremor models.
9. Requires frame bracket modification

»» FRONT INSTALLATION

1. Park the vehicle on a clean, flat surface, and block the rear wheels for safety.
2. Raise the front of the vehicle and support with jack stands at each frame rail behind the lower control arms.
3. Remove the front wheels.
4. If equipped, remove the factory skid plates/splash guards. Figure 1A / B.



Figure 1A

Important—measure before starting!

Measure from the center of the wheel up to the bottom edge of the wheel opening

LF _____ RF _____

LR _____ RR _____

Caution

EPAS (Electronic Power Assist Steering), disconnect the power steering control module connector to avoid arcing of the contacts in the internal power relay from a hammer blow or impact wrench.



Figure 1B

5. Remove the brake caliper anchor bracket bolts and remove the caliper from the knuckle **Figure 2**. Hang the caliper out of the way. Do not let the caliper hang by the brake hoses.

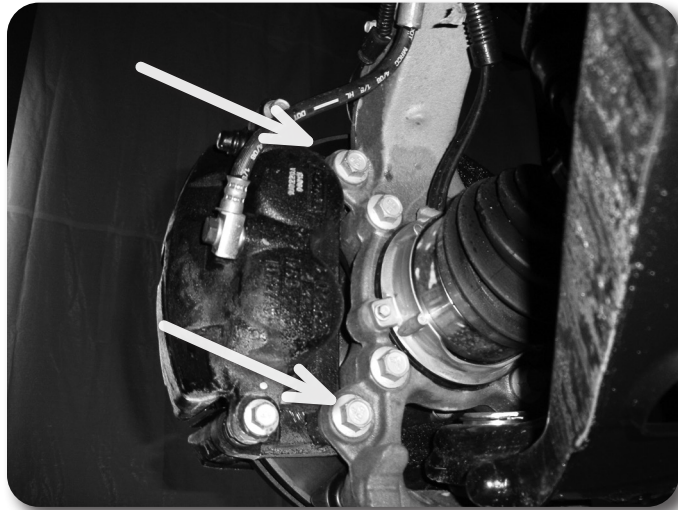

Figure 2

6. Remove the brake rotor and set aside.
7. Remove the dust shield from the knuckle and set aside.
8. Disconnect the ABS lines from the retaining clips **Figure 3A**. Remove the ABS sensor from the hub **Figure 3B**.

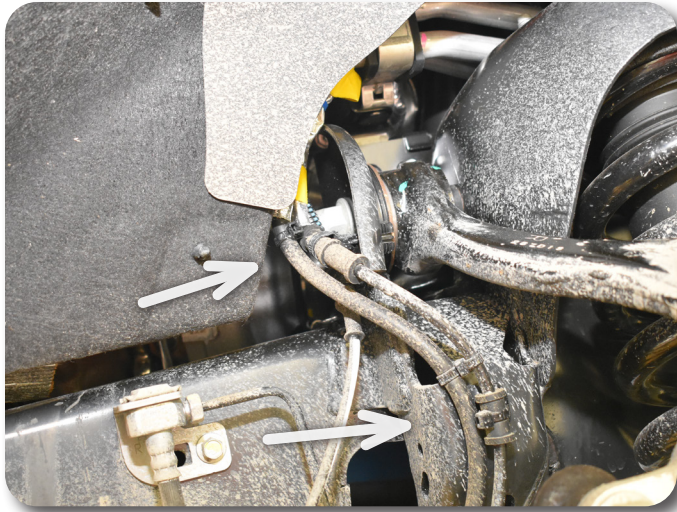

Figure 3A

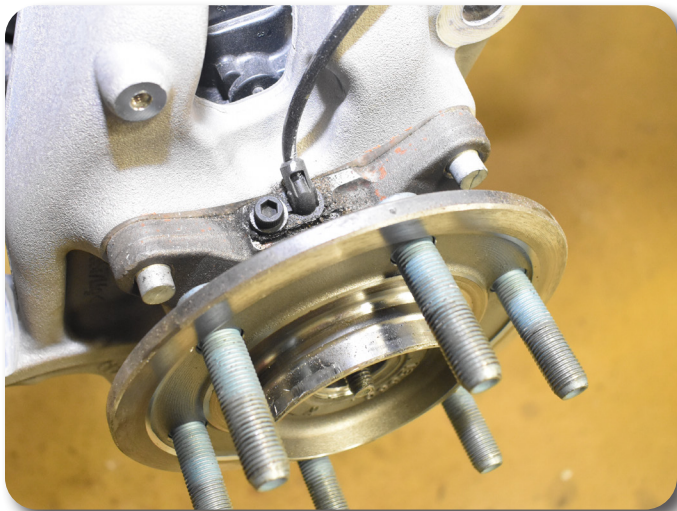

Figure 3B

9. Remove the clip attaching the brake line to the brake line bracket, save clip for later installation. Disconnect the brake line bracket from the frame rail **Figure 4A**. Slide the bracket up the brake line and carefully cut a slit in the factory brake line bracket so that it can be removed from the truck. Disconnect the brake line bracket from the steering knuckle **Figure 4B**.



Figure 4A

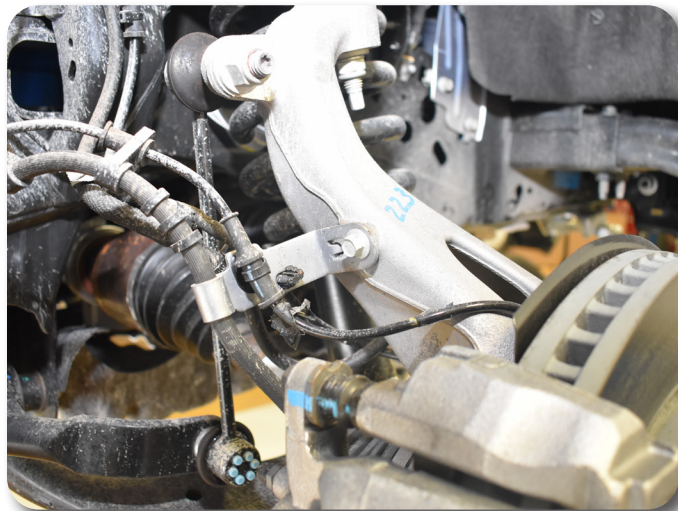

Figure 4B

Step 10 Note:

Use a tie rod end separator to release the taper from the steering knuckle.

10. Disconnect the tie rod ends from the steering knuckles. Avoid hitting the aluminum steering knuckle, use appropriate tool to remove tie rod end from steering knuckle. Take care not to strike the tie rod end, or damage the threads and boot Figure 5.

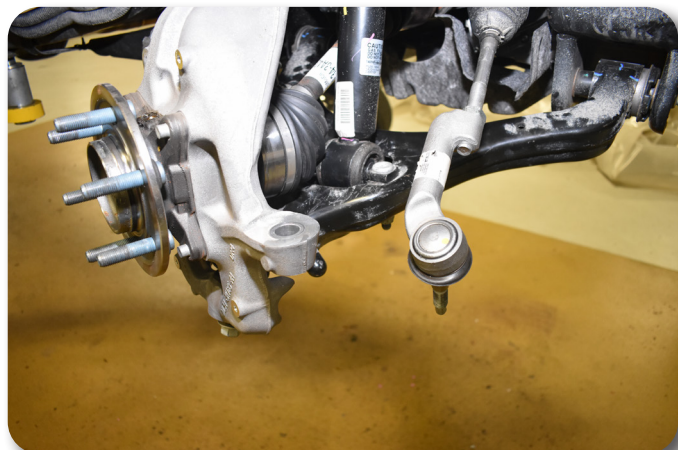

Figure 5

11. Disconnect the sway bar links from the steering knuckle **Figure 6**. The sway bar links do not need to be removed from the sway bar.
12. Remove the four sway bar mounting nuts and remove the sway bar from the vehicle **Figure 6 & 7**.

Step 12 Note:
Do not use power tools to remove the stabilizer bar link nut. Damage to the stabilizer bar link ball joint or boot may occur

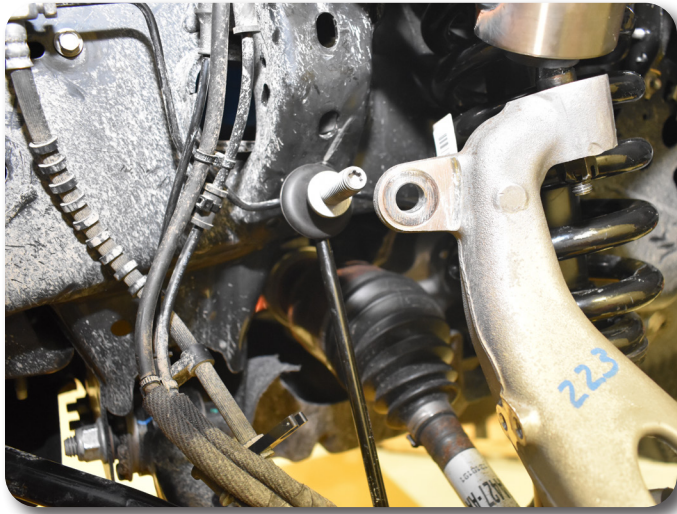

Figure 6

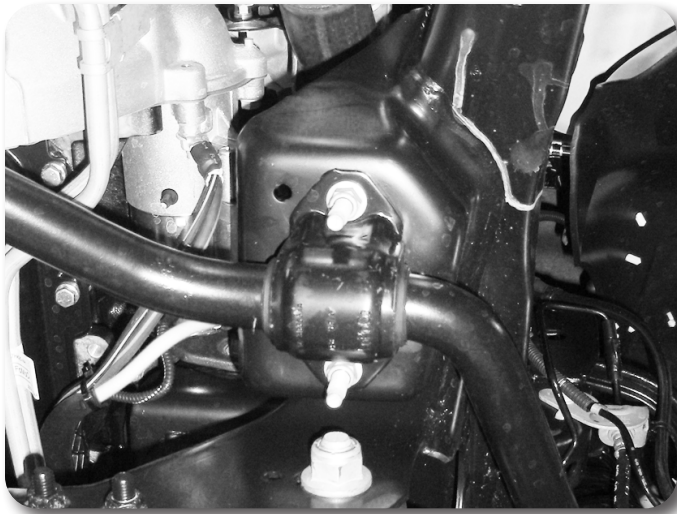

Figure 7

13. Loosen but do not remove the three strut assembly mounting nuts at the frame **Figure 8**. Do not loosen the middle strut nut.

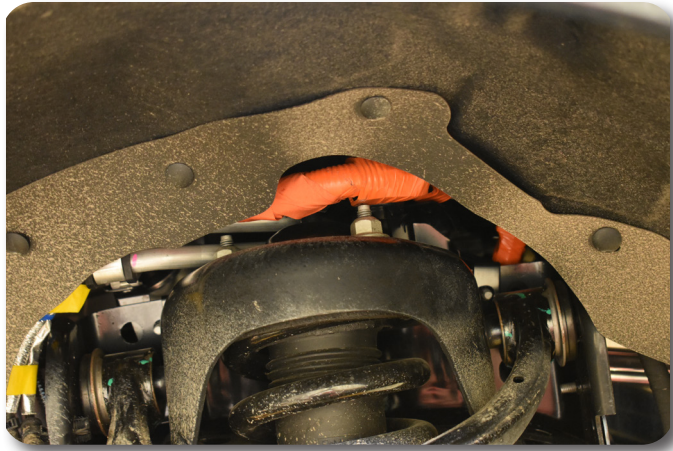

Figure 8

14. Loosen but do not remove the upper and lower ball joint nuts **Figure 9A / B**. Unseat the upper and lower ball joints from the knuckle, refrain from hitting the aluminum steering knuckle, use appropriate tool to separate ball joints, avoid damaging the threads and boot.

Step 14 Note:

Use Special Service Tool: 204-592 Separator to release the taper from the steering knuckle.



Figure 9A

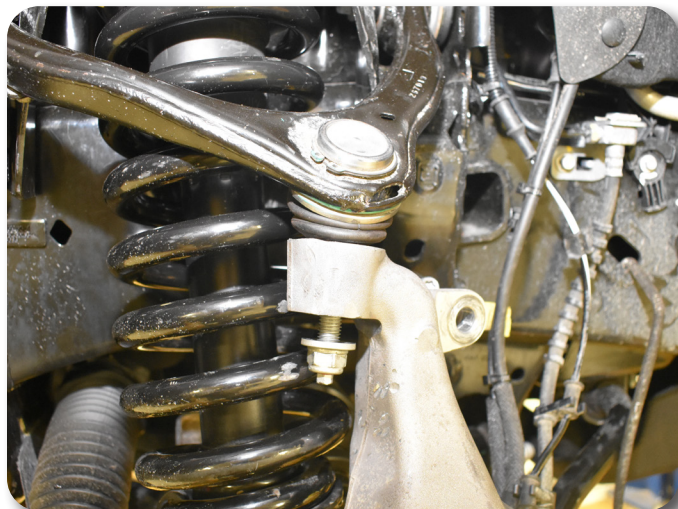

Figure 9B

15. Remove the upper ball joint and the strut-to-lower control arm hardware. Swing the knuckle/lower control arm down.
16. Remove the lower ball joint nut and remove the knuckle from the vehicle.
17. Mark the struts to distinguish between driver's and passenger's.
18. Remove the three strut assembly mounting nuts at the frame and remove the strut assembly from the vehicle.
19. Remove the lower control arm mounting bolts and remove the lower control arm from the vehicle **Figure 10**.



Figure 10

20. Take a wire brush and remove the material from the threads of the four bolts that attach the OE rear cross member. Remove the bolts and cross member from the vehicle. Discard the cross member and hardware **Figure 11**.



Figure 11

21. The factory rear control arm pockets (both sides) need to be trimmed to clear the new crossmember. Measure down 1-3/8" from the bottom of the OE control arm bolt slot on the front face of the control arm mount and make a horizontal cut line. Make a vertical cut up to the horizontal cut where the vertical offset in the factory mount begins. **Figure 12**

Step 22 Note:

Hardware for the cross member / sway bar drop to frame is in Bolt Pack 773.

Step 22 Note:

Check clearance on the passenger side between the frame and rear crossmember. The factory frame crossmember mount may need to be cleared out due to factory frame variance.

If the hardware is difficult to install it might be necessary to open up the factory cam slot due to frame mounting width variances

Step 24 Note:

Nuts for the cam bolts are in the bag kit.

Step 25 Note:

Hardware for the crossmember braces are in Bolt Pack 773.

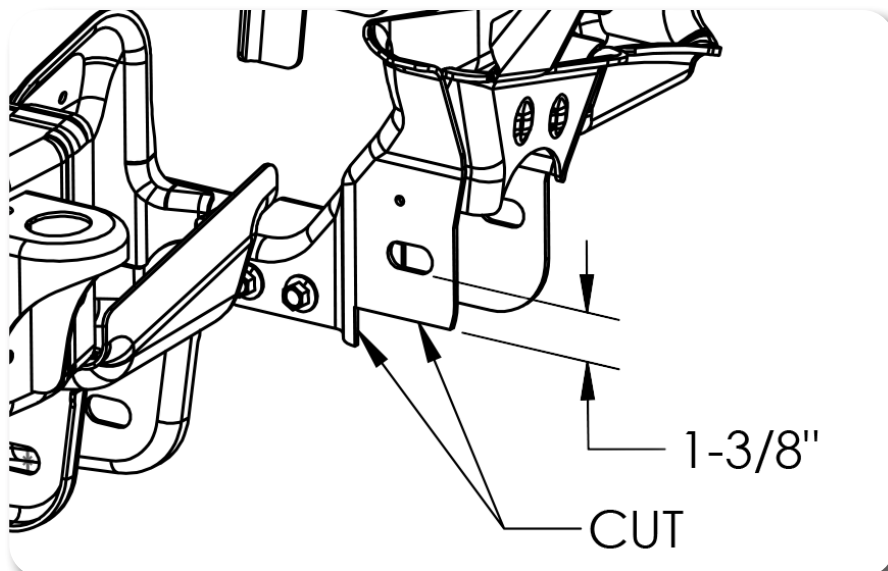

Figure 12

22. Install the new rear cross member in the rear lower control arm frame pockets. Attach the rear crossmember with the new sway bar drop brackets and new 18mm bolts and washers. Run bolts from rear to front (Figure 13). Leave hardware loose. Ensure the cutout made in the previous step is adequate to clear the differential mounting bolt Figure 13. Do not tighten hardware at this time.



Figure 13

23. Install the front cross member in the front lower control arm pockets and fasten with the OE lower control arm hardware running hardware from front to rear. Leave hardware loose.
24. Install the lower control arms in the new cross members and fasten with the provided 18mm cam bolts, cam washers and 18mm nuts. Run the front bolts from front to rear and leave loose. Run the rear bolts from rear to front. The main body of the cam will be 'up' in the cam slot
25. Install the provided crossmember braces to the front and rear cross members with 1/2" x 1-1/4" bolts, washers and nuts for the rear cross member. Leave hardware loose.

26. Attach the sway bar drop brackets to the frame using the factory nuts and nut tabs. Snug but do not tighten at this time.



Tip Use a ratchet extension through the lower slots to access the hardware (Figure 14A / B)

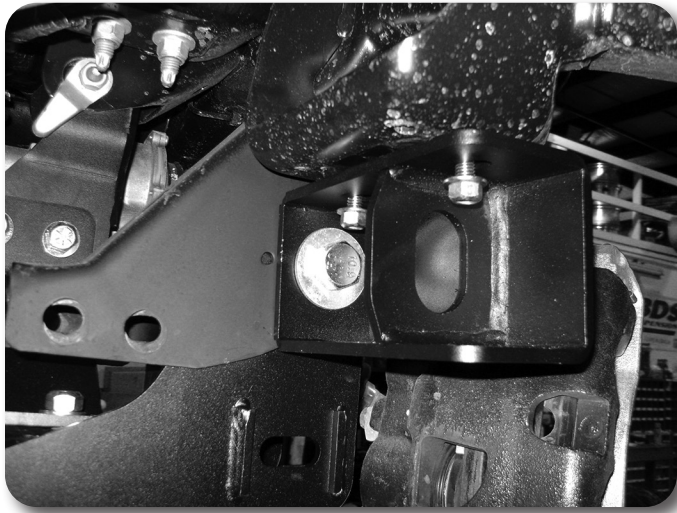

Figure 14A

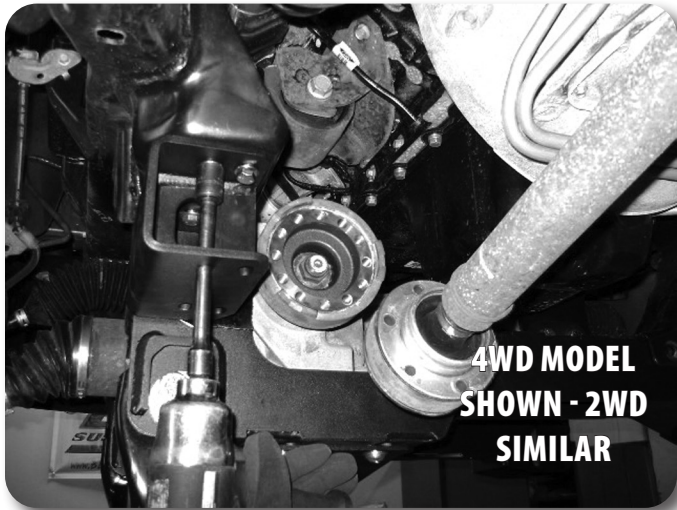

Figure 14B

27. With the lower control arms installed torque the four cross member mounting bolts to 222 ft-lbs. Ensure that the front cross member is centered in the vehicle. Torque the differential skid plate bolts to 65 ft-lbs. Tighten sway bar drop hardware to 35 ft-lbs.

» STRUT INSTALLATION

28. The same strut spacer is used on both sides. Place the strut spacer on each strut and attach with new 10mm nuts. Tighten to 40 ft-lbs.
29. Install the strut and spacer assembly into the vehicle. Attach to upper mount with new 7/16" nuts and washers. Leave hardware loose at this time Figure 15.

Step 28 Note:

Hardware for the strut spacer to strut is in Bolt Pack 629.

Step 29 Note:

Hardware for the strut spacer to frame is in Bolt Pack 769.

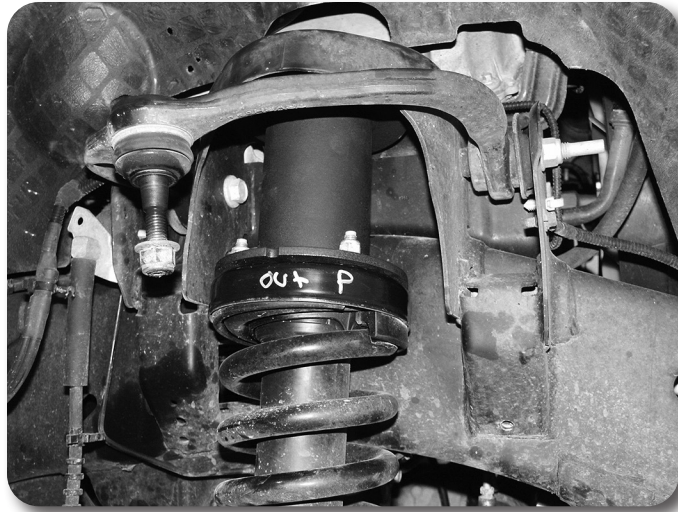

Figure 15

30. Install the hub into the corresponding new Zone knuckle and fasten with OE bolts. The ABS wire will be located at the 'top' of the hub. Use thread locker on the bolt threads and torque to 148 ft-lbs.
31. Install the new knuckle assembly on the lower control arm ball joint and loosely fasten with the original nut. Leave hardware loose.
32. Attach the upper control arm to the knuckle with an OE nut.
33. Torque the upper ball joint to 85 ft-lbs
34. Torque the lower ball joint to 111 ft-lbs.
35. Torque the upper strut nuts to 35 ft-lbs.
36. Torque the lower strut mount bolts to 66 ft-lbs
37. Install tie rod from top-down with an OE nut. Torque to 111 ft-lbs.
38. Install the brake line relocation brackets at the frame with an OE bolt. Attach the brake line to the new bracket using the clip removed previously Figure 16.



Figure 16

39. Install the dust shield with the factory 6mm bolts, tighten bolts securely (about 5-7 ft-lbs).
40. Install the brake rotor and caliper to the knuckle with OE bolts using thread locker. Torque to 148 ft-lbs.

41. Install the sway bar to the new sway bar drop brackets with 7/16" x 1-1/4" bolts, nuts and 3/8" USS washers. Attach the sway bar end links to the steering knuckles with an OE nut. Torque the 7/16" hardware to 50 ft-lbs. Torque sway bar link nut to 111 ft-lbs.
42. Attach the ABS line to the connector at the inner fender if disconnected. Route the lines similar to the factory setup down to the side of the knuckle. Attach the brake line with a new 8mm x 18mm bolt with 5/16" washer to the side of the knuckle, the brake line locating tab will go into the un-threaded hole **Figure 17A / B**. Use the provided "oval fir tree" cable ties as needed along with regular cable ties to hold the ABS lines out of the way of the tire and sway bar.

Step 41 Note:

Hardware for the sway bar to sway bar drop is in Bolt Pack 407.

Step 41 Note:

Do not use power tools to attach the stabilizer bar link nut. Damage to the stabilizer bar link ball joint or boot may occur

Step 42 Note:

Hardware for the brake line bracket to knuckle is in Bolt Pack 773.

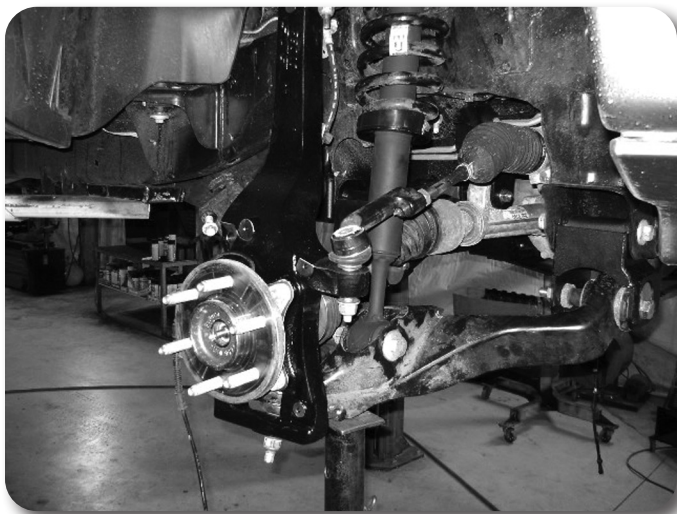

Figure 17A

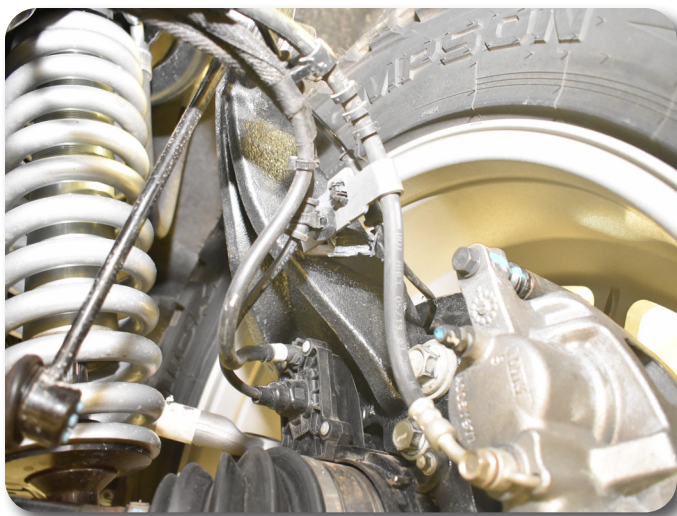

Figure 17B

43. Install the wheels and lower the vehicle to the ground.
44. Bounce the front of the vehicle to settle the suspension. Center the lower control arm cams and torque to 250 ft-lbs. Adjust the toe before driving it to an alignment shop.
45. Cycle steering, the crash bars that protrude from the frame may create clearance issues with the front tires. Modifications may be required for clearance.
46. Check all hardware for proper torque.

>> **REAR INSTALLATION**

47. Block the front wheels and raise the rear of the vehicle. Place jack stands under the frame rails ahead of the spring hangers.
48. Remove the wheels.
49. Disconnect the rear brake line from the frame. Save bolt for later installation.
50. Support the rear axle with a hydraulic jack.
51. Remove the OE shocks. Retain mounting hardware.
Note: Perform the rear installation on one side at a time.
52. Remove the axle u-bolts on one side of the axle.
53. Lower the axle and remove the OE lift block (if installed), it will not be reused.

>> **3-1/4" REAR BLOCK KIT INSTALLATION**

54. Install the rear blocks. Align the center pins and raise axle.
55. Attach radiused u-bolts with the factory lower u-bolt plate, factory upper u-bolt plate, high nuts and washers (Bolt Pack #896). Snug u-bolts, they will be torqued with the weight of the vehicle on the springs
56. Remove the factory bump stop. There is a bolt in the center of it attaching it to the frame.
57. Place the proved bump stop extension between the frame and the bump stop cup and fasten with the provided 10mm x 80mm bolts and washers (Bolt Pack #896). Hold the bump stop extension so it remains centered on the cup as the bolt is tightened **Figure 18**. Tighten hardware to 35 ft-lbs.

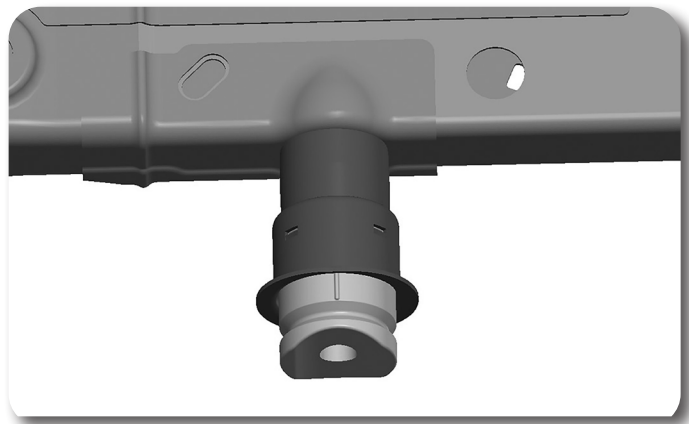

Figure 18

Step 58 Note

Hardware for brake line relocation bracket is located in bolt pack 896 depending upon which rear lift height kit is used..

58. Install the provided brake line relocation bracket (05025) to the driver's side frame rail with the OE brake line bracket bolt **Figure 19**. Torque to 15 ft-lbs.



Figure 19

59. For rear 4" kits, Vehicles equipped with a factory dual exhaust have the brake lines ran down the center. Install the provided 5/8"x1-7/8" Sleeve using BP1100 to space the brake line bracket off the rear axle. **Figure 20**



Figure 20

60. Attach the brake line to the relocation bracket with the 5/16" bolt, nut and washer (Bolt Pack #896). Torque to 15 ft-lbs.
61. Install the provided new shocks with the OE hardware. Torque all shock hardware to 35 ft-lbs..
62. Install the wheels and lower the vehicle to the ground.
63. Bounce the rear of the vehicle to settle the suspension.
64. Torque the u-bolts to 100-120 ft-lbs.

»» FINAL INSTALLATION NOTES

65. Check all lines/wires for proper slack.
66. Reconnect the power steering control module connector.
67. Check all hardware for proper torque
68. Check hardware after 500 miles.
69. A complete front end alignment is necessary.
70. Adjust headlights.

Post-Installation Warnings

1. Check all fasteners for proper torque. Check to ensure for adequate clearance between all rotating, mobile, fixed, and heated members. Verify clearance between exhaust and brake lines, fuel lines, fuel tank, floor boards and wiring harness. Check steering gear for clearance. Test and inspect brake system.
2. Perform steering sweep to ensure front brake hoses have adequate slack and do not contact any rotating, mobile or heated members. Inspect rear brake hoses at full extension for adequate slack. Failure to perform hose check/ replacement may result in component failure.
3. Perform head light check and adjustment.
4. Re-torque all fasteners after 500 miles. Always inspect fasteners and components during routine servicing.