

INSTALLATION GUIDE



Part#: 022644



HARDCORE LIMITED LIFETIME WARRANTY

4" & 6" High Clearance Suspension System

Dodge Ram 1500 4WD | 2025-2026

Rev. 033126

491 W. Garfield Ave., Coldwater, MI 49036 • Phone: 517-279-2135

E-mail: tech-bds@ridefox.com

Read And Understand All Instructions And Warnings Prior To Installation Of System And Operation Of Vehicle.

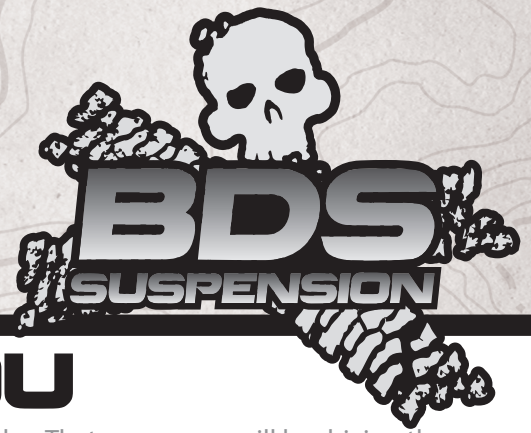

THANK YOU

Your truck is about to be fitted with the best suspension system on the market today. That means you will be driving the baddest looking truck in the neighborhood, and you'll have the warranty to ensure that it stays that way for years to come. Thank you for choosing BDS Suspension!

BEFORE YOU START

BDS Suspension Co. recommends this system be installed by a professional technician. In addition to these instructions, professional knowledge of disassembly/ reassembly procedures and post installation checks must be known.

FOR YOUR SAFETY

Certain BDS Suspension products are intended to improve off-road performance. Modifying your vehicle for off-road use may result in the vehicle handling differently than a factory equipped vehicle. Extreme care must be used to prevent loss of control or vehicle rollover. Failure to drive your modified vehicle safely may result in serious injury or death. BDS Suspension Co. does not recommend the combined use of suspension lifts, body lifts, or other lifting devices. You should never operate your modified vehicle under the influence of alcohol or drugs. Always drive your modified vehicle at reduced speeds to ensure your ability to control your vehicle under all driving conditions. Always wear your seat belt.

BEFORE INSTALLATION

- Special literature required: OE Service Manual for model/year of vehicle. Refer to manual for proper disassembly/reassembly procedures of OE and related components.
- Adhere to recommendations when replacement fasteners, retainers and keepers are called out in the OE manual.
- Larger rim and tire combinations may increase leverage on suspension, steering, and related components. When selecting combinations larger than OE, consider the additional stress you could be inducing on the OE and related components.
- Post suspension system vehicles may experience drive line vibrations. Angles may require tuning, slider on shaft may require replacement, shafts may need to be lengthened or trued, and U-joints may need to be replaced.
- Secure and properly block vehicle prior to installation of BDS Suspension components. Always wear safety glasses when using power tools.
- If installation is to be performed without a hoist, BDS Suspension Co. recommends rear alterations first.
- Due to payload options and initial ride height variances, the amount of lift is a base figure. Final ride height dimensions may vary in accordance to original vehicle attitude. Always measure the attitude prior to beginning installation.

BEFORE YOU DRIVE

Check all fasteners for proper torque. Check to ensure for adequate clearance between all rotating, mobile, fixed, and heated members. Verify clearance between exhaust and brake lines, fuel lines, fuel tank, floor boards and wiring harness. Check steering gear for clearance. Test and inspect brake system.

Perform steering sweep to ensure front brake hoses have adequate slack and do not contact any rotating, mobile or heated members. Inspect rear brake hoses at full extension for adequate slack. Failure to perform hose check/



Visit 560plus.com for more information.
TIRES AND WHEELS

6" Lift Wheel and Tire Specs			
Tires	Wheel Size	Backspacing	Trimming
37" x 12.50"	20x9	5"	Required
37" x 12.50"	20x9	5.5"	May be Required
*** 18" wheels, see note below			
4" Lift Wheel and Tire Specs			
Tires	Wheel Size	Backspacing	Trimming
35" x 12.50"	20 x 9	5"	May be required
35" x 12.50"	20 x 9	5.5"	May be required
*** 18" wheels, see note below			
*** 18 INCH WHEELS MAXIMUM RECOMMENDED BACKSPACING IS 4.5". TEST FIT WHEELS ON VEHICLE BEFORE MOUNTING TIRES. ENSURE CLEARANCE OF WHEEL BARREL TO NEW TIE ROD END. ADHESIVE WHEEL WEIGHTS MUST BE USED ON INBOARD WHEEL PROFILE.			
Stock 18" wheels cannot be re-installed. Stock 20" & 22" can only be re-installed with the factory tire.			
2025+ Ram 1500 Bumper Spacer Kit (BDS122004) recommended for additional tire-to-fender clearance. Sold separately.			

replacement may result in component failure. Longer replacement hoses, if needed can be purchased from a local parts supplier.

Perform head light check and adjustment.

Re-torque all fasteners after 500 miles. Always inspect fasteners and components during routine servicing.

CONTENTS OF YOUR KIT

022642 Box Kit

Part #	Qty	Description
02242	1	Drive Shaft Spacer
03947	1	Rear Crossmember
01298B	1	Skid Plate
663	1	Drive Shaft Spacer Bolt Pack
	4	12mm-1.75 x 45mm Bolt
	4	12mm Flat Washer
480	1	Differential Bracket Mounting Bolt Pack
	3	12mm-1.75 x 40mm Bolt
	2	12mm-1.75 x 60mm Bolt
	2	12mm-1.75 x 55mm Bolt
	11	12mm Flat Washer
	4	12mm-1.75 Prevailing Torque Nut
	3	1/2"-13 x 1-1/2" Bolt
	4	1/2"-13 x 1-1/4" Bolt
	3	1/2"-13 Prevailing Torque Nut
	10	1/2" SAE Washer
BP1024	1	Bolt Pack
	2	1/4"-20 x 5/8" Bolt
	2	1/4" Split Lock Washer
	4	1/4" SAE Washer
	4	Wire Clip
	6	10mm-1.5 Prevailing Torque Nut
	6	10mm Flat Washer
	4	3/8" - 16 Prevailing Torque Nut
	8	3/8" SAE Washer
	4	3/8"-16 x 1-1/4" Bolt
	4	Cushion Washer
02002ZP	4	M18-2.5 x 150 Bolt
N18MPT	4	M18 - 2.5 Prevailing Torque Nut
03982	8	Square Washer
01499	4	1/4" Spacer Washer
342702	1	Thread Locker Pouch
03888	2	Brake Line Relocation Bracket
631	1	Bolt Pack - Brake Line Relocation Bracket
	2	1/2"-13 x 1-1/4" Bolt
	2	1/2"-13 Prevailing Torque Nut
	4	1/2" SAE Washer
22545	2	Front Brake Line (2019-2024 model years only)
5188	2	Brake Line Clip
CCW-03-050	4	3/8" Brake Line Crush Washer
099000	6	Nylon Cable Tie

022660 & 022661 Knuckle Box Kits - Standard Bore

Part #	Qty	Description
05624	1	Front Steering Knuckle -DRV
05625	1	Front Steering Knuckle -PASS
401-2038	2	Tie Rod End w/Nut
W96S	2	9/16 SAE Washer

022662 & 022663 Knuckle Box Kits - LARGE BORE

Part #	Qty	Description
05626	1	Front Steering Knuckle LARGE BORE-DRV
05627	1	Front Steering Knuckle LARGE BORE -PASS
401-2038	2	Tie Rod End w/Nut
W96S	4	9/16 SAE Washer
05636	2	Large Bore ABS Spacer

022644 Front Box Kit

Part #	Qty	Description
03946	1	Front Crossmember
03658	1	Diff Drop Bracket PASS
03656	1	Diff Drop Bracket Inner DRV
03655	1	Diff Drop Bracket Outer DRV
03661	1	Diff Drop Bracket Rear DRV - 3.6L and 5.7L
05621	1	Diff Drop Bracket Rear DRV - 3.0L
BP1092	1	Bolt Pack
	1	12mm-1.75 x 45mm Bolt
	1	12mm Flat Washer
03931	1	Sway Bar Drop Bracket DRV
03932	1	Sway Bar Drop Bracket PASS
01572	1	BDS Badge
97525A430	2	Rivets

122633 Box Kit - Coilover Mounting Kit - 6" LIFT ONLY

Part #	Qty	Description
05632	2	Coilover Upper Mounting Bracket
BP1088	1	Bolt Pack
	6	10mm-1.5 x 30mm Bolt
	12	10mm Flat Washer
	6	10mm-1.5 Prevailing Torque Nut
	2	1/2"-13 x 2-3/4" Bolt
	4	1/2" SAE Washer
	2	1/2"-13 Prevailing Torque Nut

PRE INSTALLATION

IMPORTANT

It is required that ride height measurements be taken before and after installation. Measure from the **WHEEL AXLE CENTER** up to the **FENDER LIP** of the wheel opening. Do this for all 4 wheels. Record measurements below.**

BEFORE

Left Front _____ *Right Front* _____

Left Rear _____ *Right Rear* _____

AFTER

Left Front _____ *Right Front* _____

Left Rear _____ *Right Rear* _____

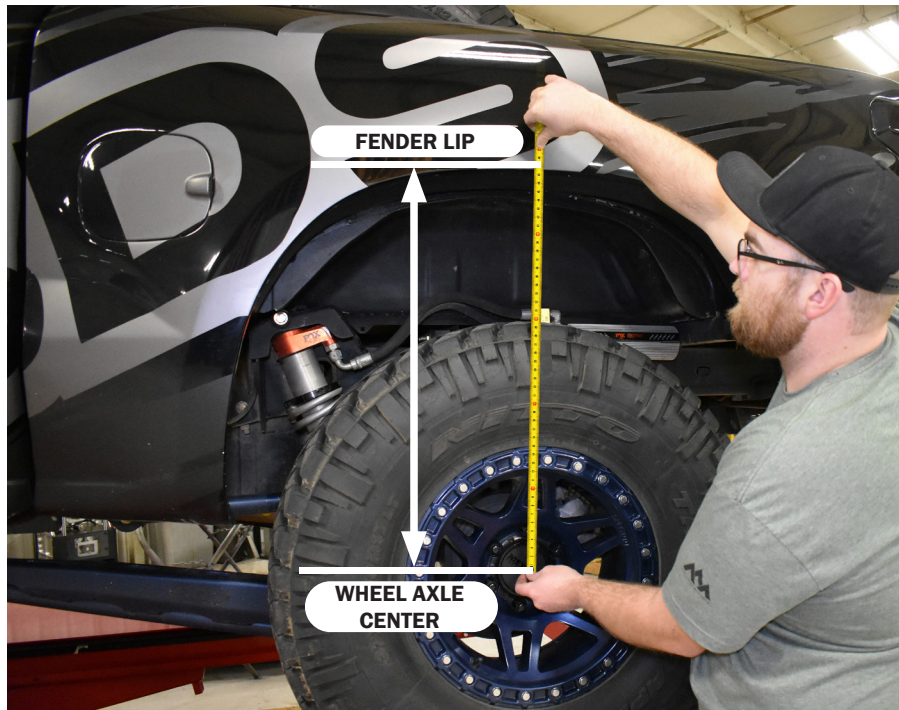

****These ride heights will be required if you have any ride height concerns after installation. Please be prepared to provide these to Technical Support.**

TROUBLESHOOTING INFORMATION FOR YOUR VEHICLE

1. Will not fit air suspension equipped models.
2. Ensure you have the correct knuckles. Models equipped with factory 22" wheels require large bore knuckles, BDS022662 and BDS022663.
3. 22545 brake lines fit 2019-2024 model years only. For 2025+ models, use kit included 03888 brake line drop brackets and 631 bolt pack to mount the drop brackets.
4. Lift kit fits 3.0L, 3.6L, and 5.7L engines. Refer to the differential instruction sections for corresponding bracket-to-engine type fitment..

INSTALLATION INSTRUCTIONS

PRE-INSTALLATION MEASUREMENTS

Measure and record ride heights as described on page 4.

IMPORTANT

1. Disconnect BOTH batteries (**if equipped**). Disconnect the auxiliary battery first using a 10mm socket and or wrench (**Fig. A**). Disconnect the main battery using a 10mm socket and or wrench. (**Fig. B**) The positive terminal on the main battery has a clip holding it in place. Use a trim tool or flat head screw driver to pry up the clip to remove terminal. (**Fig. C**) Cover terminals to prevent electric arc.



FIGURE A

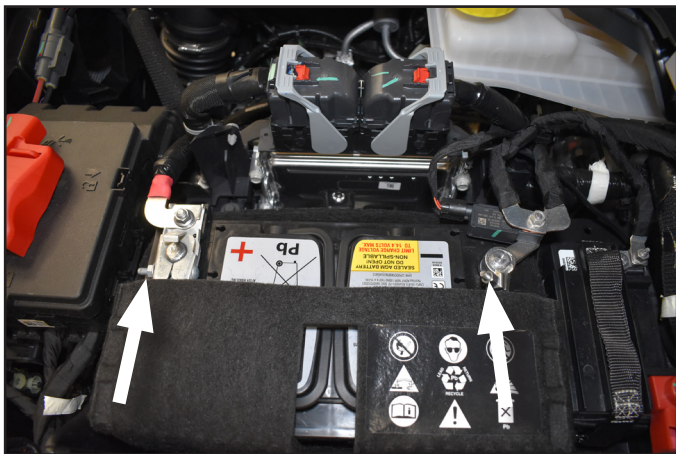

FIGURE B



FIGURE C

FRONT INSTALLATION

2. Park the vehicle on a clean, flat surface and block the rear wheels for safety.
3. Raise the front of the vehicle and support with jack stands under the frame rails.
4. Remove the wheels.
5. Disconnect the sway bar links from the lower control arm. Leave the links attached to the sway bar. **(Figure 1).**

FIGURE 1



6. Remove and discard the OE front skid plate, if equipped.
7. Disconnect the tie rod ends from the steering knuckles. Remove and retain the mounting nuts. Use the appropriate puller to separate the tie rod end from the steering knuckle.
8. Disconnect the ABS brake line at the frame. Remove it from any retaining clips.
9. Disconnect the brake line hardware from the strut tower and pull the brake line through the mount. Cut a slot to allow the brake line to be removed from the frame. If you do not wish to cut on the coil bucket, the line can be disconnected and reconnected after it is removed from the frame. If the line is disconnected the brakes must be bled once the installation is completed. **(Figure 2)**

FIGURE 2



10. Attach the provided brake line relocation bracket to the frame where the original line mounted. Torque the factory bolt to 15 ft-lbs and the 1/2" bolt to 56 ft-lbs. The brake line drop bracket hardware is located in bolt pack 631.

IMPORTANT!! Replacement front brake lines (22545) do not work on 2025+ model year trucks: fitment of 22545 includes 2019-2024 model years.

11. Carefully reform the hard-line to gain additional length. Attach brake line to the relocation bracket with 5/16" x 3/4" bolt, nut, and washers. Torque to 13 ft-lbs. (**Figure 3**).

FIGURE 3



12. Repeat brake line relocation bracket installation on the passenger's side of the vehicle.
13. Remove the brake caliper anchor bracket bolts and pull the caliper free from the steering knuckle and rotor. Hang the caliper securely out of the way. Retain caliper mounting hardware.



Tip Do not allow the brake caliper to hang from the brake line.

14. Remove the brake rotor torx screw from the hub using a T30 Torx bit. Remove brake rotor from the hub.
15. Remove ABS sensor from knuckle (**Figure 4**). Route the wires and sensor away from the knuckle and tuck out of the way.

FIGURE 4



16. Remove the hub axle nut using a 35mm socket. Retain nut.
17. Loosen but do not remove the lower control arm bolts.
18. Disconnect the CV axles from the differential by carefully prying CV out at the differential to disengage the internal retaining clip. Pry the shaft out just enough to release the clip and leave the axle on the differential at this time.

19. Support the lower control arm with a hydraulic jack. Remove the three strut-to-frame mounting nuts (**Figure 5**).

! Caution *DO NOT loosen the middle strut nut. Doing so could result in injury or death.*

FIGURE 5



20. Loosen the strut-to-lower control arm hardware. Remove the nut from the bolt and leave the bolt in place to temporarily retain the strut to the lower control arm. Retain the nut.
21. Remove the upper and lower ball joint nuts. Reinstall the nuts a few turns by hand. Separate the upper and lower ball joints from the steering knuckle using the appropriate puller. Take care not to damage the ball joint.
22. Remove the upper ball joint nut. Lower the jack enough to allow removal of the strut. Remove the lower strut bolt and remove the strut from the vehicle. Mark the strut from the appropriate side (**driver's or passenger's**). Retain mounting bolt and upper ball joint nuts.
23. Continue to lower the jack allowing the knuckle/CV axle and lower control arm to swing down. Slide the CV axle off of the differential. Remove the CV axle from hub.
24. Remove the lower ball joint nut and remove the knuckle from the lower control arm. Retain the lower ball joint nut.
25. Remove the three bolts mounting the hub bearing assembly to the OE steering knuckle. Retain the mounting bolts. Remove the hub assembly and dust shield from the knuckle.
26. Install the hubs in the corresponding new knuckles (**05624/05625 for standard bore knuckles, or 05626/05627 for large bore knuckles**) and fasten with the stock mounting bolts (**Figure 6**). The ABS line runs out the front side of the knuckle toward the steering arm. Use thread locker on the hub bolt threads and torque to 37 + 165° ft-lbs.

FIGURE 6



27. Remove the lower control arms from the frame. Retain hardware.
28. Make indexing marks on the front drive shaft and differential input flange for realignment later (**Figure 7**). Remove the four bolts and disconnect the drive shaft from the differential. Support the driveshaft to keep the CV boot from binding. Discard mounting bolts.



Tip Failure to support the driveshaft can lead to pinching the rubber boot at the CV joint which can damage the seal causing a leak and premature wear on the joint.

FIGURE 7



29. Remove sway bar mounts from frame and remove sway bar assembly. Retain Hardware
30. Remove the four bolts mounting the OE rear crossmember (**Figure 8**) to the frame rails and remove the crossmember from the vehicle. Discard the crossmember and the hardware.

FIGURE 8



31. For 2025+ model years with 3.0L engine, it is recommended the steering rack be removed to aid in removal of the front differential.

IMPORTANT!! Ensure steering wheel is positioned so both front wheels are straight forwards. Lock steering wheel in place before working on the steering rack.

32. Disconnect the four plugs from the steering rack. **(Figure 9)**

FIGURE 9

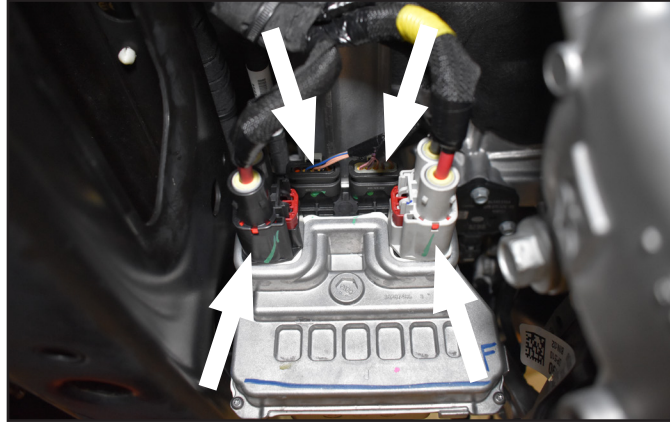

33. Disconnect the steering rack wiring harness from frame with a trim tool and reposition harness plugs up and out of the way. **(Figure 10)**

FIGURE 10



34. Disconnect intermediate steering shaft to steering gear pinch bolt. **(Figure 11)** Save bolt for reinstallation.



Tip *Bolt should be accessible if steering wheel is in wheels-straight forward orientation.*

FIGURE 11

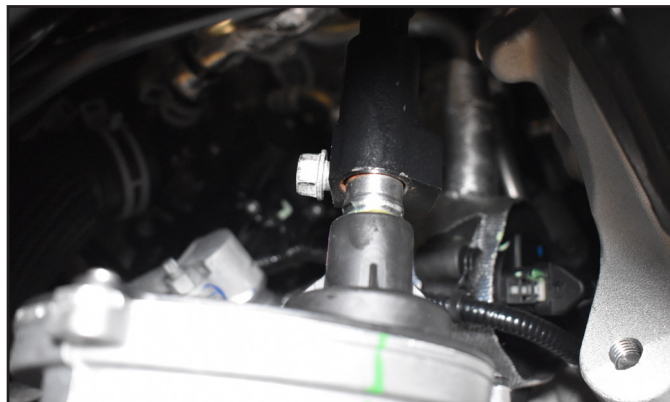

35. Support the steering rack and remove the two mounting bolts at the front crossmember. Save for reinstallation. **(Figure 12)**

FIGURE 12

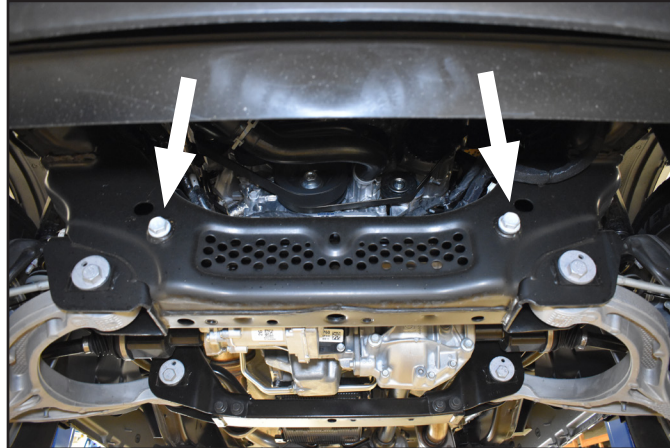

36. Disconnect the Front Axle Disconnect (FAD) wire harness connector and wire clips at the frame. **(Figure 13, 14)**

FIGURE 13

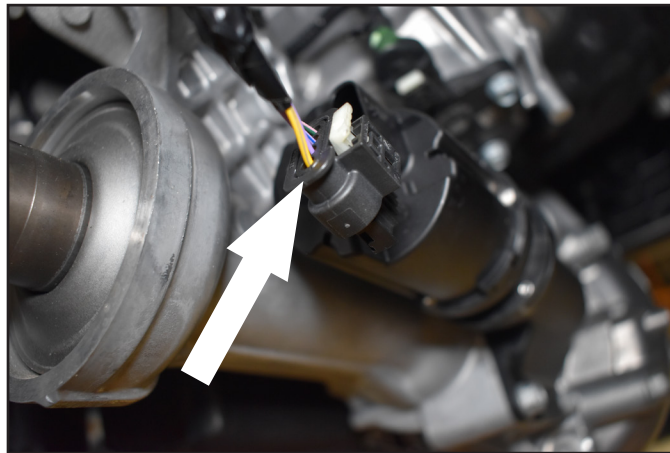

FIGURE 14



- 37. For 2025+ trucks equipped with 3.0L I6 Hurricane engines, follow Steps 38-42. For 2025+ trucks equipped with 3.6L V6 Pentastar and 5.7L Hemi engines, follow Steps 43-45.**

38. Trucks with 3.0L I6 Hurricane Engines: Disconnect three transmission coolant line brackets to allow better access when removing the differential mounting bolts. Front bracket uses a 13mm wrench or deep well socket, and a 6" minimum extension. **(Figure 15, 16)**. Start at the first bracket near the A/C compressor following the lines rearward. Save hardware for reinstallation.

Note: Trucks with 3.6L and 5.7L engines do not need to disconnect the transmission coolant lines to gain better access to differential.

FIGURE 15

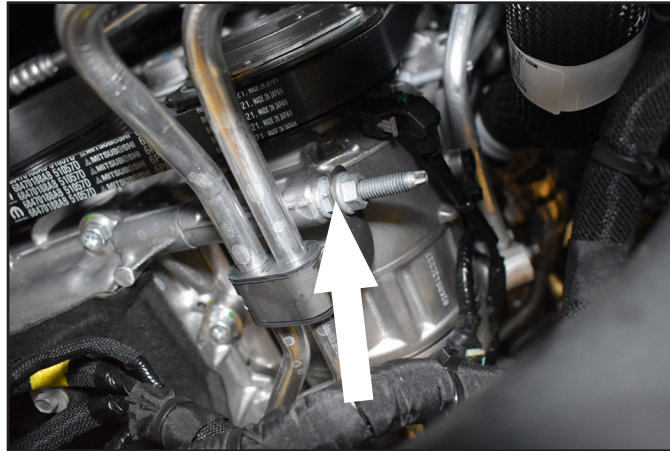
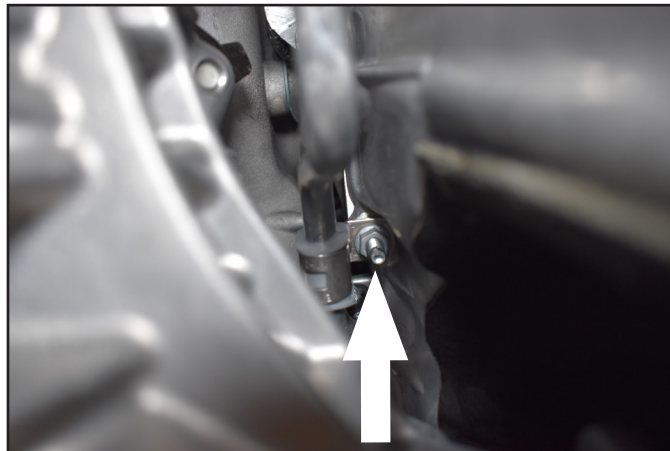

FIGURE 16



39. Remove two upper differential bolts using a 18mm chrome short socket and a cheater bar to break free. Loosen the bolt half way, then switch to an 18mm swivel ratcheting wrench. Remove the front bolt using an 18mm chrome short socket. **(Figure 17, 18)**

NOTE: Bolt is too long to run out all the way with a ratchet and will become lodged in place.

FIGURE 17



FIGURE 18

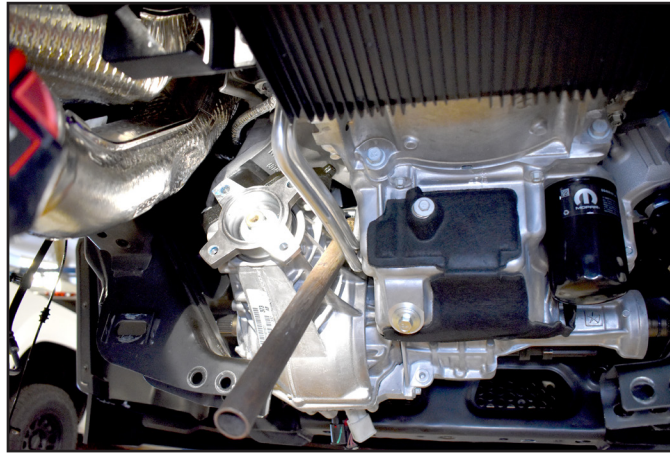

40. If vehicle is on a hoist, place a transmission jack under the differential. If working on the ground, support the differential with a floor jack.
41. Remove the three rear differential bolts at the engine mount-to-differential spacer using a 12" extension with 19mm short socket, swivels at both impact and socket. Access is best from the wheel well, over the frame. **(Figure 19, 20)**

 **Tip** *Have an assistant help guide sockets to bolt heads as necessary.*

FIGURE 19

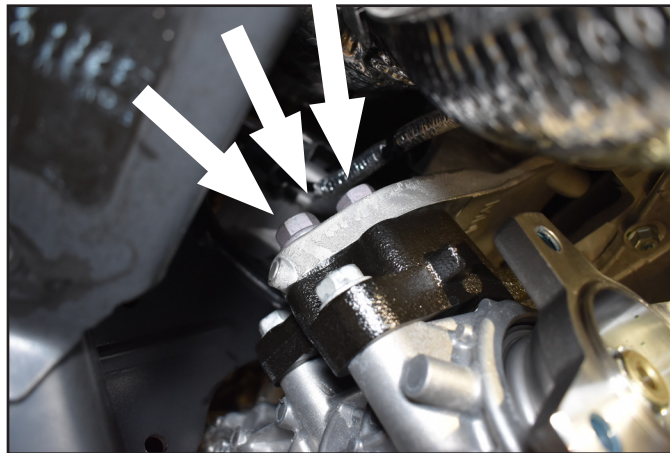
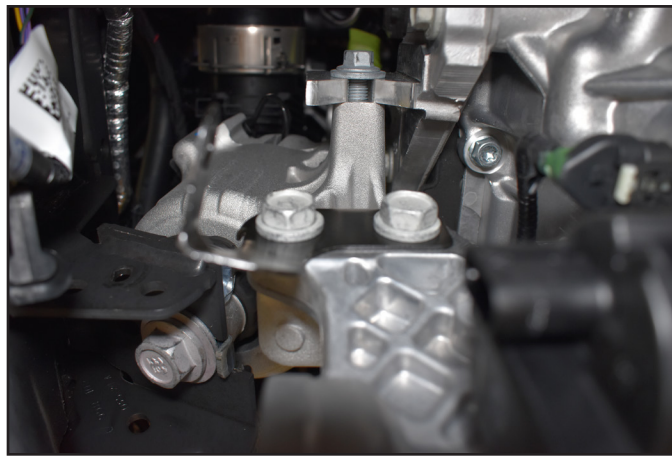

FIGURE 20



42. Remove two front differential bolts (**passenger side**) using an 18mm socket. It may be necessary to loosen with an impact then complete removal with a ratchet. (**Figure 21**) Securely support the differential and lower from the vehicle.

FIGURE 21



43. **3.6L V6 Pentastar and 5.7L Hemi engines:** Loosen but do not remove the three rear driver's side bolts (**Figure 22**) and the two passenger's side bolts (**Figure 23**). On the passenger's side, if equipped, remove the differential actuator cable bracket: it will not be reused. Disconnect the Front Axle Disconnect (**FAD**) wiring connector from the differential.

FIGURE 22

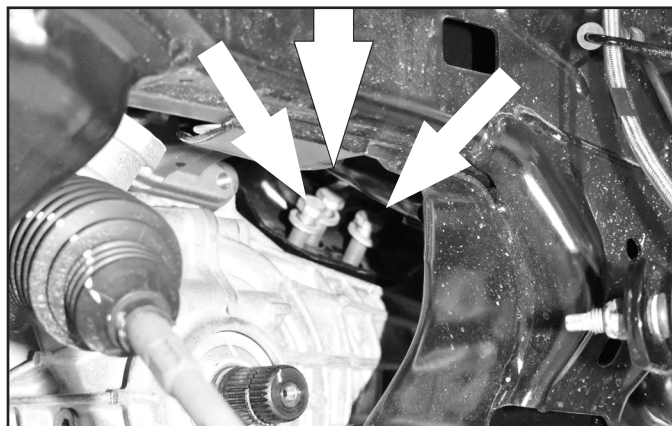
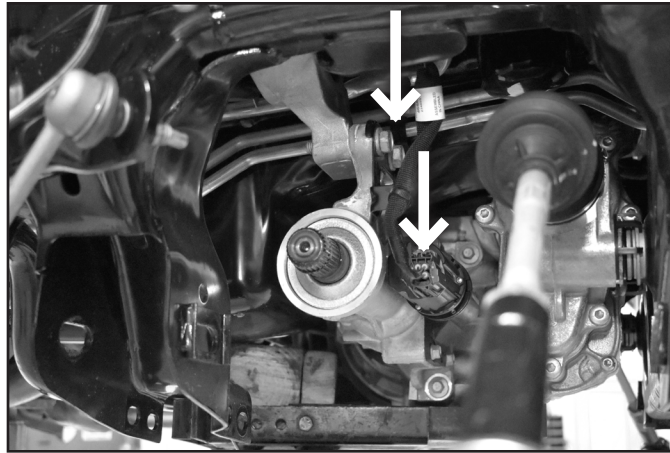

FIGURE 23



44. Ensure the differential is supported. Loosen and remove the two forward-most differential mounting bolts on the driver's side, manipulating the wiring harness location in order to gain clearance. **(Figure 24)**

TIP: If using a ratcheting wrench, make sure it is reversible as you may get into a position where it gets stuck on the rib of the differential.

FIGURE 24

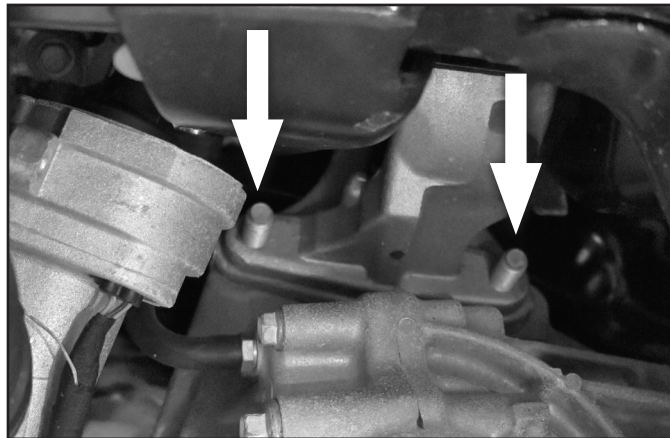

45. Remove three bolts on driver rear side and with the differential securely supported, lower the differential from the vehicle.
46. The driver's side rear lower control arm pocket must be trimmed to provide clearance for the differential in its lowered position. Measure inward from the inside edge of the alignment cam slot 1-3/4" and mark. Repeat on the opposite side of the pocket. Make a continuous line connecting the two marks over the top edge of the pocket. Trim the pocket on the line with a sawzall or cut off wheel. Paint any exposed metal to prevent corrosion **(Figure 25)**.

FIGURE 25

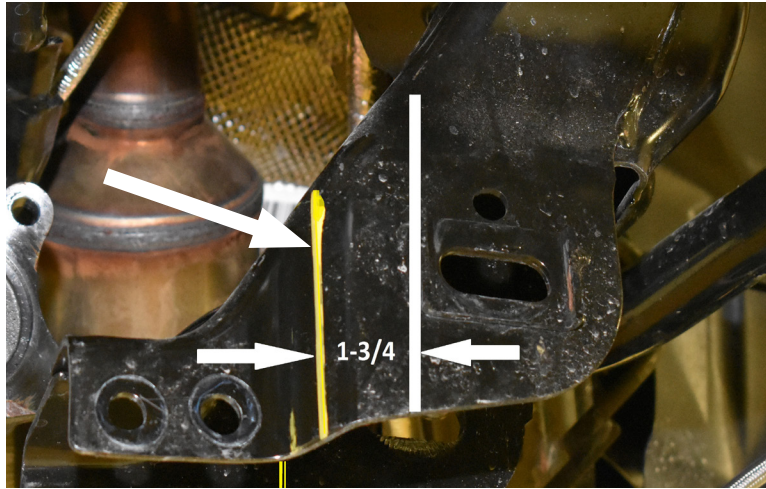

47. Cut the rear passenger side as shown in **(Figure 26, 27)** Mark 3" from inside edge, cut up to bend in stamped bracket and then cut straight out perpendicular to the angled surface. Cut using a sawsall or equivalent.

FIGURE 26



FIGURE 27

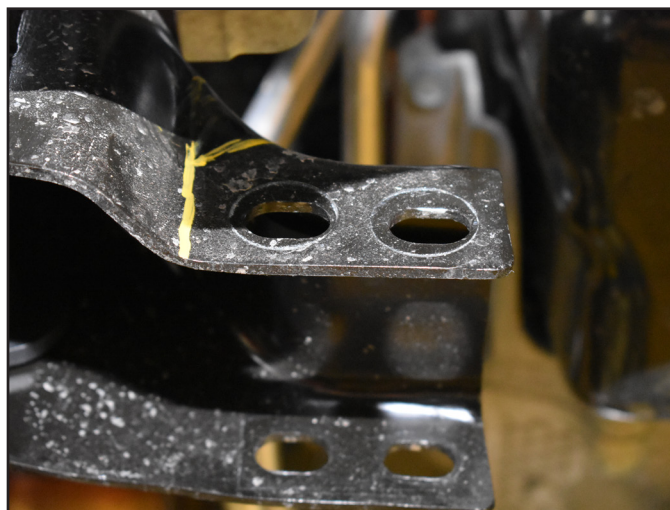

48. On the driver side rear cross member pocket, measure 1-1/4" downwards from center hole and trim horizontally for additional clearance for the new crossmember. **(Figure 28)** Repeat for passenger side. Clean up cut edges with a flapper sanding disc and coat with paint.

FIGURE 28

2025+ trucks with 3.0L I6 Hurricane engines, follow STEPS 51-55. Trucks with 3.6L V6 Pentastar and 5.7L Hemi engines, follow STEPS 56-61. Use Figure 31 below to identify the correct kit included bracket to install for your specific engine type.

FIGURE 31

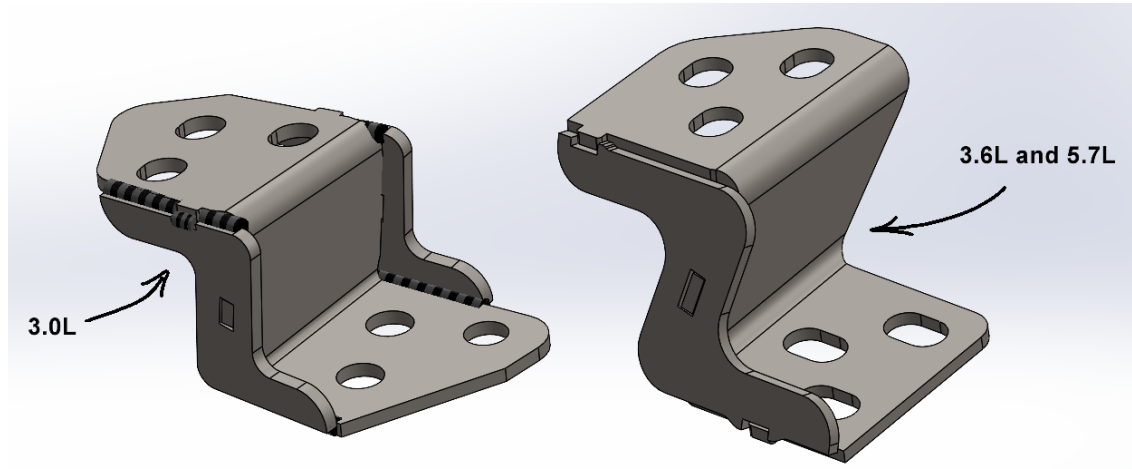

51. **3.0L I6 Hurricane engines:** Apply thread locker and loosely install rear drop bracket (**05621**) to the differential with the OE hardware. Three holes on the provided bracket mount to the cast spacer, three slots upwards to the engine mount. (**Figure 32**)



Tip 3.0L rear differential drop bracket has two gussets and mounting holes on the differential mounting surface. 3.6L and 5.7L rear bracket has slots on the differential mounting surface, notched surface towards the frame mount.

FIGURE 32

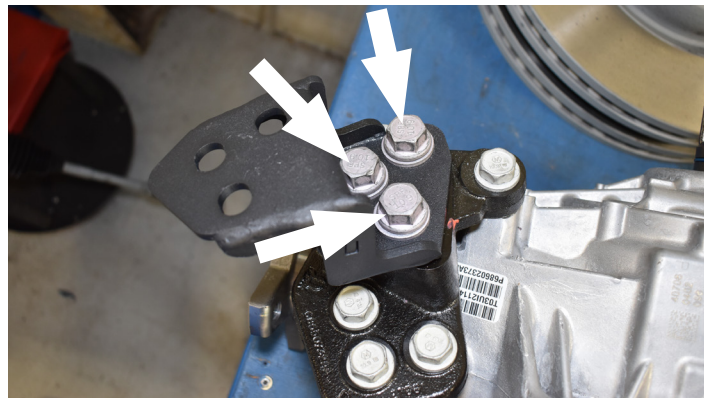

52. Using a jack and an assistant to aid in balancing, raise the differential up to the driver and passenger side drop brackets.
53. Attach the differential to the driver's side front bracket and passenger's side bracket with 12mm x 60mm bolts, nuts and washers (**BP #480**). Use the 1/4" washers (**01499**) on both sides of the differential and between the front diff brackets. (**Figure 33, 34**)

FIGURE 33

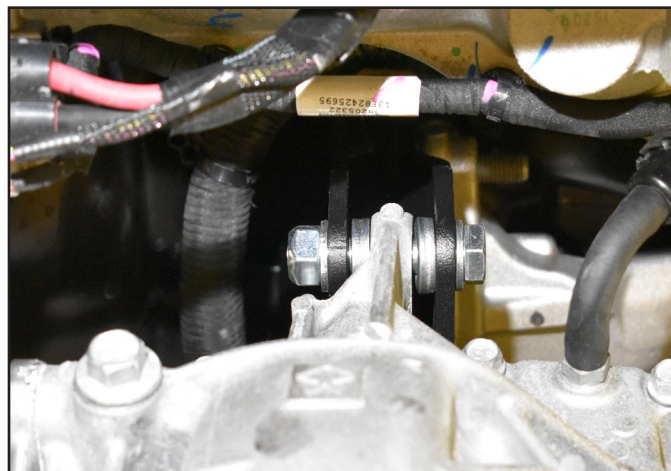
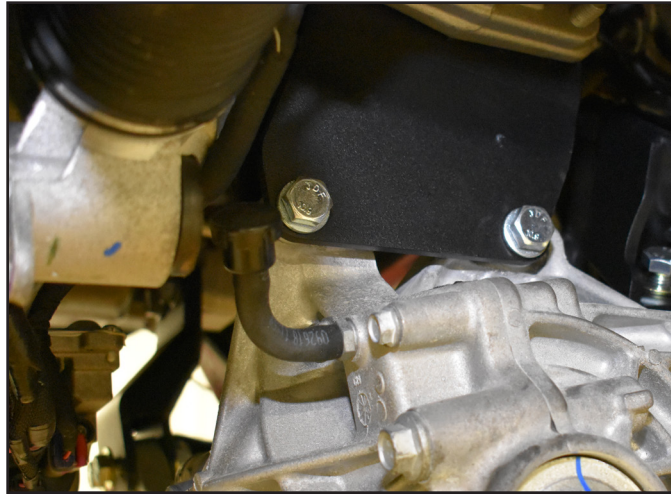
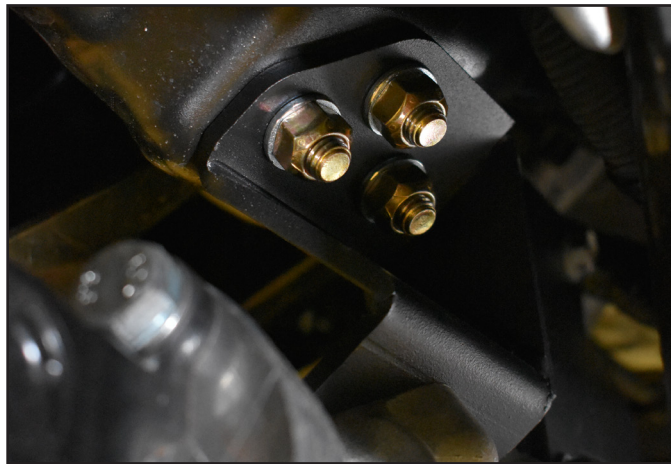

FIGURE 34



54. Fasten z-differential drop bracket to the engine mount with 1/2"-13 x 1-1/2" bolts, 1/2" SAE washers, and prevailing torque nuts. Do not torque at this time. Hardware for the differential drop brackets is located in bolt pack 480.
55. Torque differential mounting bolts: Start by tightening the driver side new brackets to the factory mounting positions (**upper bolts**), then working your way from driver side to passenger side tightening the brackets to the differential (**lower bolts**). Torque 1/2" hardware to 80 ft-lbs and the 12mm hardware to 70 ft-lbs.
56. **3.6L V6 Pentastar and 5.7L Hemi engines:** Install the driver's side rear differential drop bracket (**03661**) to the OE mount location with three 1/2" x 1-1/2" bolts and 1/2" SAE washers (**BP #480**). The bracket gusset plate faces towards the front of the vehicle (**Figure 35**). Leave hardware loose.

FIGURE 35



57. Using a jack and an assistant to aid in balancing, raise the differential up to the new brackets.

58. Attach the differential to the driver's side front bracket and passenger's side bracket with 12mm x 60mm bolts, nuts and washers (**BP #480**). Use the 1/4" washers (**01499**) on both sides of the differential and between the front diff. brackets. (**Figure 36, 37**)

FIGURE 36

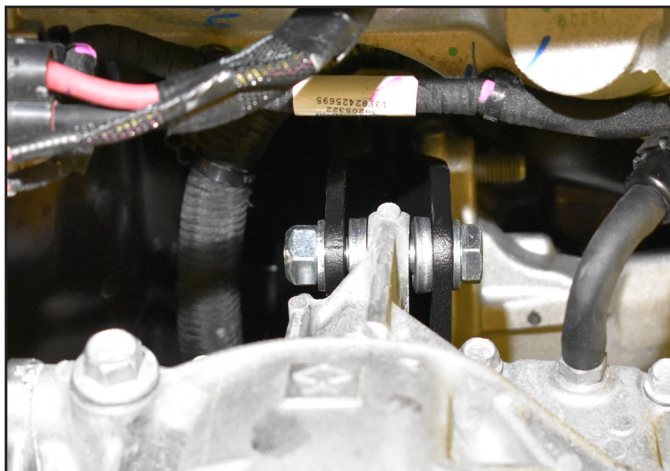

FIGURE 37



59. Attach the drivers side rear bracket to the differential with 12mm x 40mm bolts and washers (**BP #480**). Leave all differential hardware loose. (**Figure 38**).

FIGURE 38



60. Attach the passenger side differential to the bracket using 12mm x 60mm bolts and washers. **(BP 480) (Figure 39)**

FIGURE 39

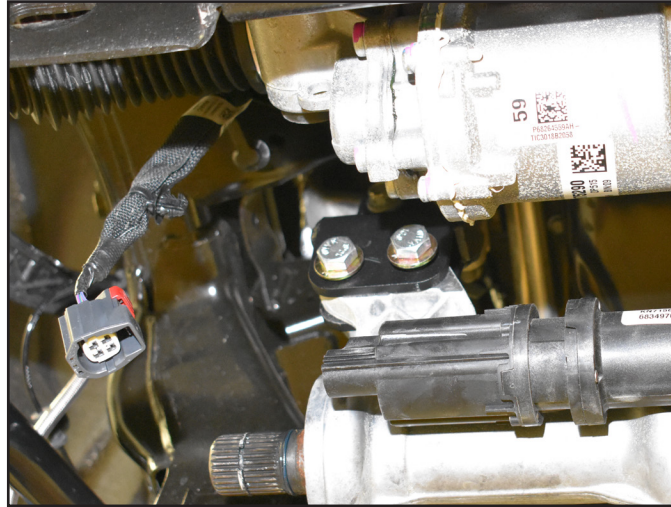

61. Torque all 14 differential mounting bolts, start by tightening the new brackets to the factory mounting positions (**upper bolts**), then work your way from driver side to passenger tightening the brackets to the differential (**lower bolts**). Torque the ½" hardware to 80 ft-lbs and the 12mm hardware to 70 ft-lbs.
- 62. ALL ENGINE PLATFORMS:** Locate the Front Axle Disconnect (**FAD**) wiring harness. Remove from factory clips to give enough slack to reach the differential. Reattach connector to the differential and tie up extra slack with provided zip ties.
63. Install the new front crossmember (**03946**) in the OE front lower control arm pockets (**Figure 40**) and loosely fasten with the provided 18mm x 150mm bolts, nuts in conjunction with the cam slot washers (**03982**). See next step for information on the adjustable cam washers.
- Note: The offset in the crossmember goes to the front, bolts run from front to rear.*
64. Provided cam washers allow for adjustability to compensate for frame variances. (**Figure 41**). When installing cam washers determine in what position fits best to your frame. Make sure whatever position the cam washer is in that the other side is opposite. For example, if your frame is wide, you would offset your cam washers to the outside of the vehicle on either side.

FIGURE 40

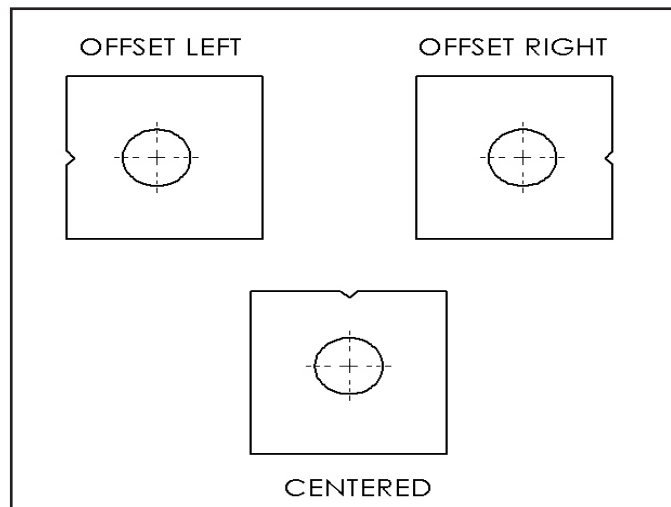

FIGURE 41



65. Install sway bar drop brackets (**03931/03932**) using OE hardware in the upper sway bar mounts. Torque bolts to 33 ft-lbs (**Figure 42**).

FIGURE 42



66. Install the new rear crossmember (**03947**) in the OE rear lower control arm pockets and loosely fasten with the provided 18mm x 150mm bolts, nuts in conjunction with the provided cam slot washers (**03982**). Run the bolts from front to rear and leave loose at this time. (**Figure 43**)

FIGURE 43

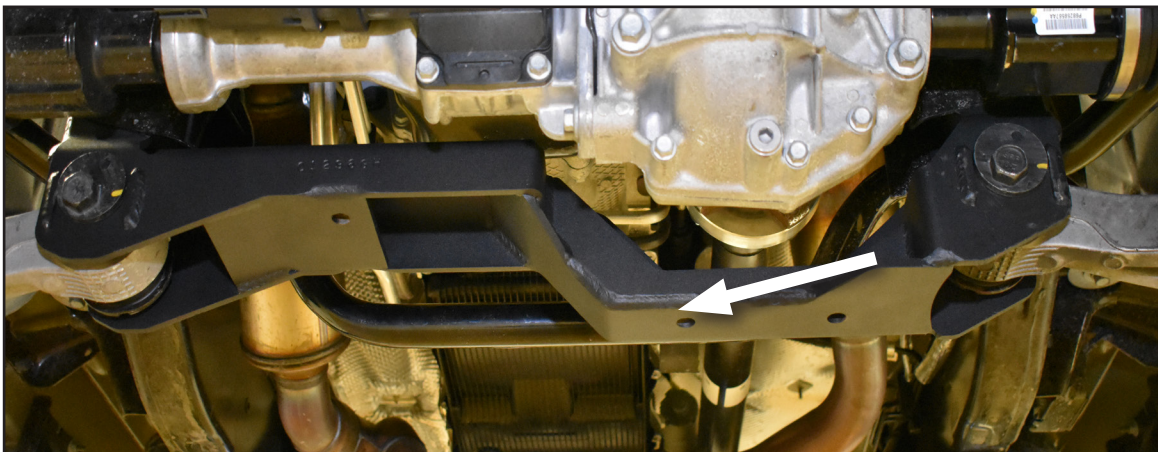

67. Verify Front Axle Disconnect (FAD) wiring harness slack to the front differential (from Step 62).
68. Re-install the steering rack to frame using the OE bolts, torque hardware to 118 + 90° ft-lbs. Reconnect the four wiring plugs. (Figure 44)

FIGURE 44

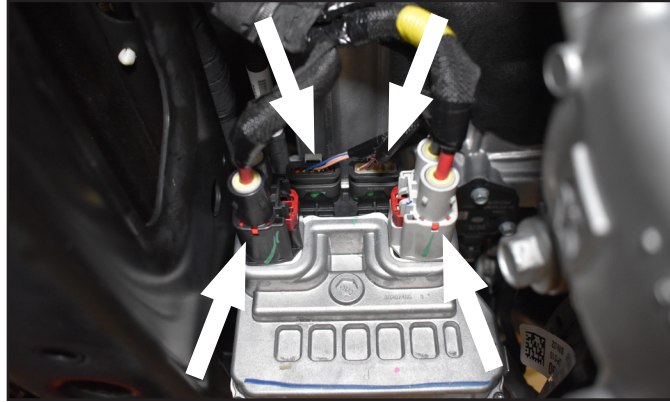

69. Re-attach the intermediate steering shaft to the steering gear. Torque pinch bolt to 41 ft-lbs.
70. Install the new differential skid plate to the front crossmember. Place cushion washers (B1280) between skidplate (01298) and crossmember mounting points and install skidplate with two, 1/2" x 1-1/4" bolts and 1/2" SAE washers (BP #480) into the welded nuts in the front crossmember. Install the back of the skid plate to the rear crossmember with remaining two cushion washers, 1/2" x 1-1/4" bolts and 1/2" SAE washers (BP #480) into the welded nuts in the crossmember. Leave hardware loose. (Figure 45)

FIGURE 45

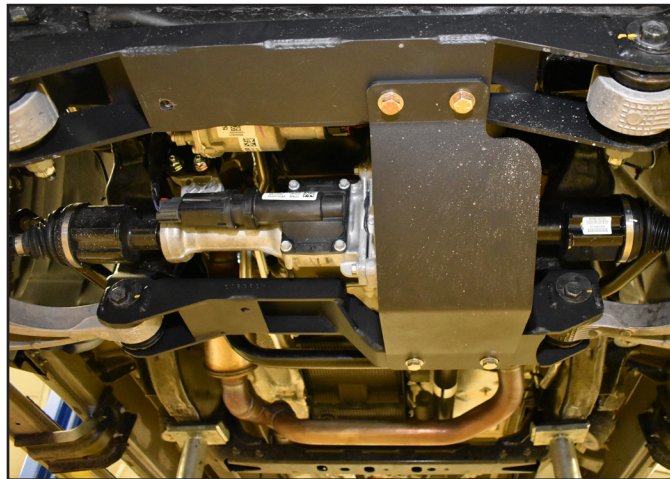

71. Install the lower control arms in the front and rear crossmembers. Attach the control arms to the crossmembers with the OE cam bolts, washers and nuts running from front to rear. Leave hardware loose. (Figure 46)

FIGURE 46



72. With the lower control arms installed, torque the 18mm crossmember mounting bolts to 239 ft-lbs. Torque the 1/2" differential skid plate hardware to 80 ft-lbs.

73. Install the provided drive shaft spacer (**02242**) on the differential input flange. Attach the front driveshaft to the differential by aligning the marks made earlier. Fasten the driveshaft and spacer to the differential flange with 12mm x 45mm bolts and 12mm washers (**BP #663**). Use thread locker on the bolt threads and torque to 70 ft-lbs. (**Figure 47**)

FIGURE 47

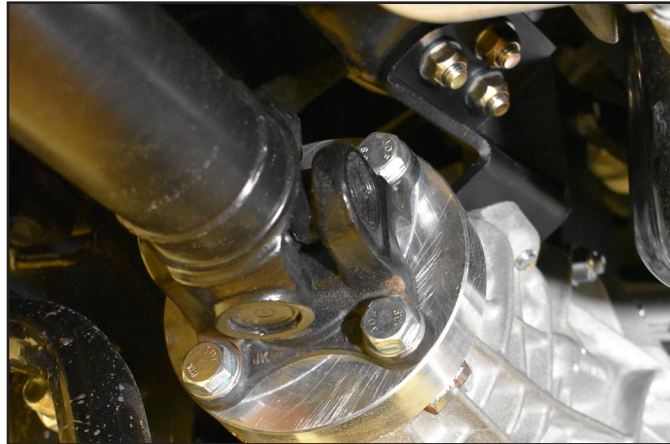

74. On some vehicles it is necessary to trim a splash guard located on the transmission shift linkage to clear the drive shaft. (**Figure 48**)

FIGURE 48

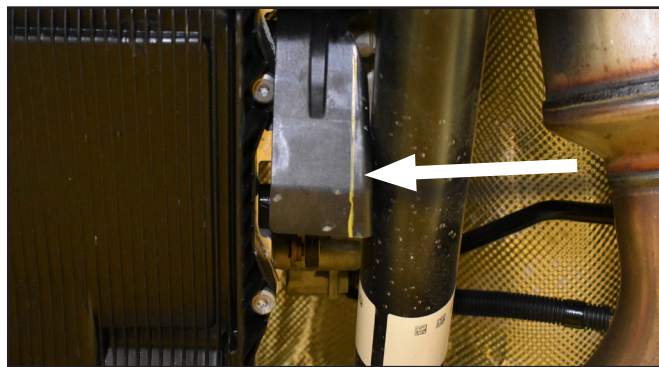

75. Install BDS logo plate on front of the crossmember using provided rivets.

FOX 2.5 PERFORMANCE ELITE SERIES COILOVER - INSTALLATION

76. For 4" coilover kits, follow the Fox kit-included installation instructions with your coilovers. For 6" coilover kits, continue below.
77. For 6" coilover kits, remove socket head cap screw bolt from the Fox installed tophat with a 3/8" hex drive socket bit. Remove the tophat, it will not be reused. Install the mounting bracket (**05632**) onto the coilover with provided 1/2" -13 x 2-3/4" bolt (**apply thread locker**), washers, and nut. Torque hardware to 80 ft-lbs. **Flare in the mounting bracket tabs face outward when mounted on the vehicle (Figure 49).**

FIGURE 49



78. Install the upper coilover mounting bracket (**05632**) and coilover into the OE upper coil seat with three, 10mm bolts, six 10mm washers, and three nuts (**BP1088**) (**Figure 50**). Flare in the mounting bracket tabs faces outward. Leave hardware loose. Repeat on opposite side of vehicle.

FIGURE 50

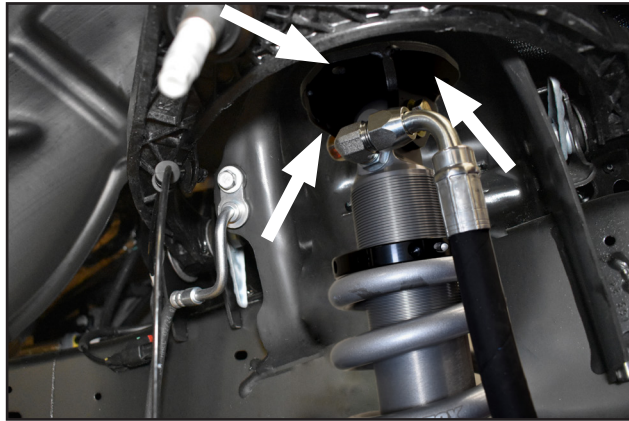

FRONT INSTALLATION (CONTINUED)

79. Install the new driver's side steering knuckle to the driver's side lower control arm ball joint and loosely attach with the original nut. Install the driver's side CV axle in the hub and loosely fasten with the original axle nut.
80. Swing the knuckle/CV assembly up while aligning the axle with the differential output shaft. Loosely attach the coilover to the lower control arm with the original hardware. Push the CV axle all the way onto the differential output to seat the internal retaining clip.
81. Support the lower control arm with a hydraulic jack and attach the knuckle to the upper ball joint with one 9/16" washer and the OE nut (**Figure 51**).

FIGURE 51



82. Torque the 10mm coilover mounting bracket hardware to 38 ft-lbs. Front lower control arm to coilover bolt will be torqued in Final Front Installation Steps section.
83. Torque the upper ball joint nut to 26 + 180° ft-lbs and the lower ball joint nut to 38 + 195° ft-lbs. Torque the axle nut to 184 ft-lbs.
84. Repeat coilover/knuckle/CV installation on passenger's side.
- 85. Large bearing knuckle kits, skip to next step.** For standard bore knuckles, route ABS line on back side of knuckle, through brake dust shield and into knuckle. Apply thread locker and torque OE bolt to 62 in-lbs. Repeat on opposite side.
86. For large bearing knuckle kits, install the supplied ABS spacer between the mounting surface and the ABS sensor. Apply thread locker and torque OE bolt to 62 in-lbs (**Figure 52**). Repeat on opposite side.

NOTE: For large bearing knuckle kits, ABS spacers located in B1658.

FIGURE 52

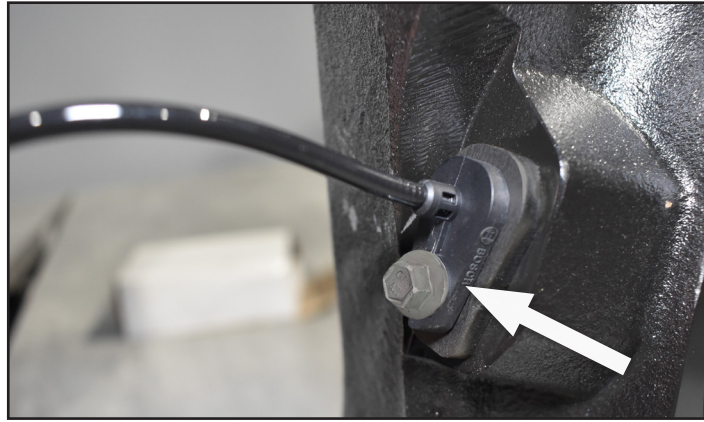

87. Install the brake rotor and caliper on the knuckle/hub. Torque the OE caliper bolts to 59 + 55° ft-lbs. Use thread locker on the caliper bolts.
88. Attach sway bar to sway bar extension mounts using 3/8-16" x 1-1/4" bolts, washers and prevailing torque nuts (**BP 481**) and torque to 33 ft-lbs (**Figure 53**). Insert sway bar link into lower control arms and fasten using OE hardware. Torque will be completed in final front installation steps.

FIGURE 53

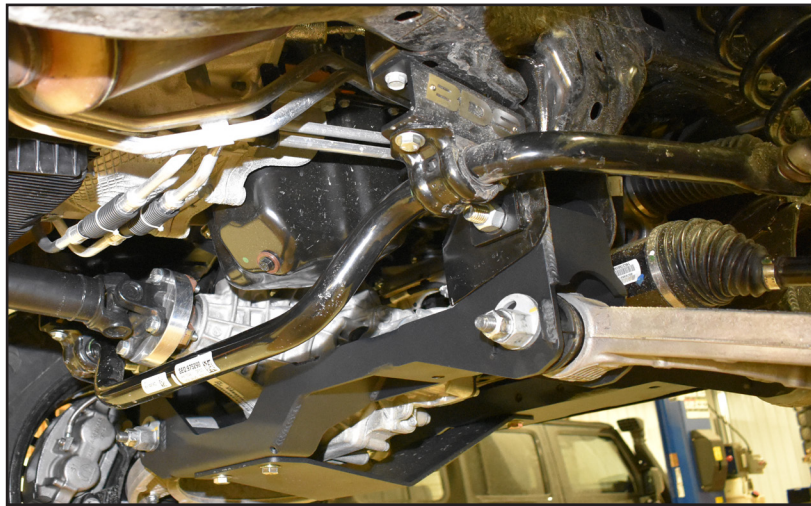

89. Remove stock tie rod ends and replace with provided replacement tie rod ends (**401-2038**). Attach the tie rod ends to the new steering knuckles with the included washer and nut. Torque to 55 ft-lbs. Securely lock off the jam nut.



Tip *When installing the provided tie rod end: 4in kits it is recommended to have approximately 2 threads exposed passed the jam nut, 6 inch kits it is recommended to keep the jam nut in the stock location for ease of alignment adjustment.*

90. Secure the ABS wire with zip ties at other locations to prevent any contact with rotating / moving parts. Ensure there is adequate slack and clearance between the brake line and suspension components.

OPTIONAL - BDS122004 BUMPER SPACER KIT INSTALL, SOLD SEPARATELY

** Provides additional tire-to-fender clearance

91. Remove the front lower inner fender liners.
92. Disconnect the bumper wire harness connectors on both driver and passenger sides. (Figure 54, 55)

FIGURE 54



FIGURE 55

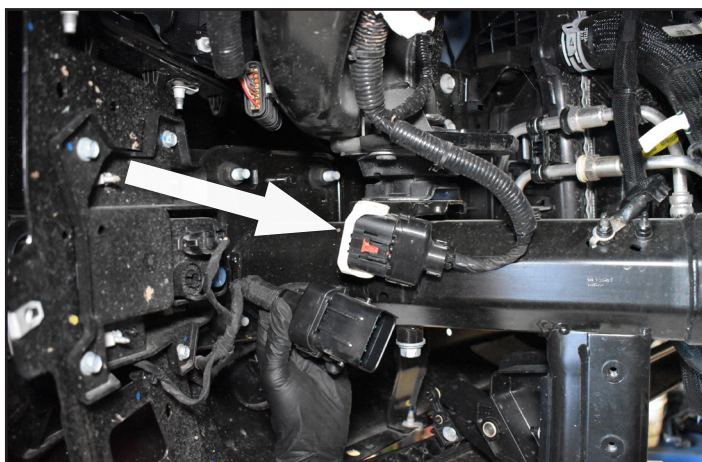

93. Disconnect the six nuts (**three per side**) mounting the bumper to the frame horns. With an assistant, remove the bumper.
94. Remove the OE pushnut retainers using a pair of side cutters. The OE carriage bolts and pushnuts will not be reused. (Figure 56)

FIGURE 56



95. Install new provided carriage bolts and pushnut retainers in the original bumper mounting locations. **(Figure 57)**

Note: Bumper Spacer hardware located in BP1087, spacers located in B1656.

FIGURE 57

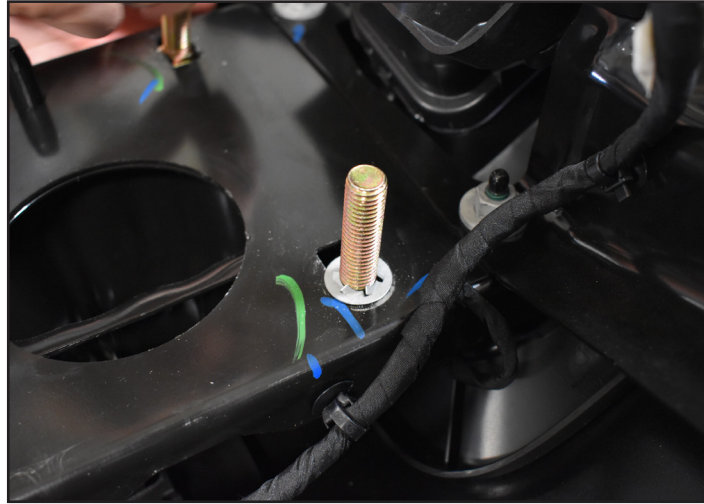

96. Remove lower accent trim attached to the bottom of the grill insert. It is held in place with four pushpins and will not be reinstated. **(Figure 58)**

FIGURE 58



97. Trim up to the bottom of the four push pin mounting holes, level, across the entire width of the grill support. It is recommended to use a reciprocating pneumatic buzz saw, cleaning up cut edge with a deburring tool. **(Figure 59)**

FIGURE 59



98. Place provided spacers (**YJTC7**) onto carriage bolts. With an assistant, loosely remount bumper to the vehicle using six provided 1/2" washers and six nuts. Adjust bumper elevation to fender gap. Torque nuts to 49 ft-lbs.
99. Reconnect both driver and passenger side bumper wire harness connectors. Reinstall lower inner fender liner.

FINAL FRONT INSTALLATION STEPS

100. Reinstall front wheels and lug nuts. Tighten but do not torque lug nut
101. Lower the vehicle to the ground and bounce the front to settle the suspension. Torque wheel lug nuts to manufacturers specifications.
102. Center the lower cams and torque lower control arm hardware to 74 + 145° ft-lbs. Torque the coilover-to-lower control arm bolts to 125 ft-lbs.
103. Torque OE sway bar link to lower control arm nut to 81 ft-lbs.
104. If the front brake lines were disconnected or replaced, the front brakes must be bled before driving vehicle. Also do a final check to ensure the brake lines will not contact the tire or other moving components.
105. Check all fasteners for proper torque. Recheck all fasteners after 500 miles and at regularly scheduled maintenance intervals.
106. A complete front end alignment is required. Do not drive the vehicle with the steering wheel off center. This can cause unsafe driving conditions.



WE WANT TO SEE YOUR RIDE!

Grab photos of your BDS-equipped truck in action and send them in for a chance to be featured. Send it in to our Bad Ass Rides customer gallery at bds-suspension.com/bar and post them on the BDS Fan Page on Facebook at facebook.com/BDSSuspensions. Don't forget about your BDS swag! BDS offers t-shirts, hoodies, decals and more available on the BDS website or through your local BDS distributor.

TIME TO HAVE SOME FUN

Thank you for choosing BDS Suspension.

For questions, technical support and warranty issues relating to this BDS Suspension product, please contact your distributor/installer before contacting BDS Suspension directly.

2025+ DODGE RAM 1500 4/6 INCH SUSPENSION SYSTEM

TORQUE SPECIFICATIONS

COMPONENT	TORQUE (FT-LBS)
Front Brake Line Factory Hardware	15
Front Brake Line 1/2" Bolt	56
Knuckle to Hub Mounting Bolts	37 + 165 °
1/2" Diff Mounting Hardware	80
12mm Diff Mount Hardware	70
Skid Plate Bolts	80
18mm Crossmember Bolts	239
Driveshaft to Differential Bolts	70
Steering Rack to Frame Bolts	118 + 90°
Intermediate Steering Shaft to Steering Gear	41
Coilover to Upper Mounting Bracket	80
Coilover Upper Mounting Bracket to Coil Seat	38
Upper Ball Joint	26 + 180°
Lower Ball Joint	38 + 195°
CV Axle Nut	184
Caliper Bracket Bolts	59 + 55°
Tie Rod To Knuckle Nut	55
OE Sway Bar Mounting Bolts	33
Sway Bar to Sway Bar Drop Bolts	33
Front Lower Control Arm Bolts	74 + 145°
Coilover to Lower Control Arm Bolts	125
Front Sway Bar Link to Lower Control Arm	81
Rear Control Arm Bracket 3/8" Hardware	35
Rear Control Arm Bracket 5/8" Hardware	95
Rear Lower Shock Bolts	107
Rear Trackbar Bracket 3/8" Hardware	35
Rear Trackbar Bracket 9/16 Hardware	95
Rear Bump Stop Hardware	18
Rear Sway Bar Link 12mm Hardware	55
Rear Upper Control Arm Hardware	111 + 110°
Rear Track Bar to Bracket	127