

# INSTALLATION GUIDE

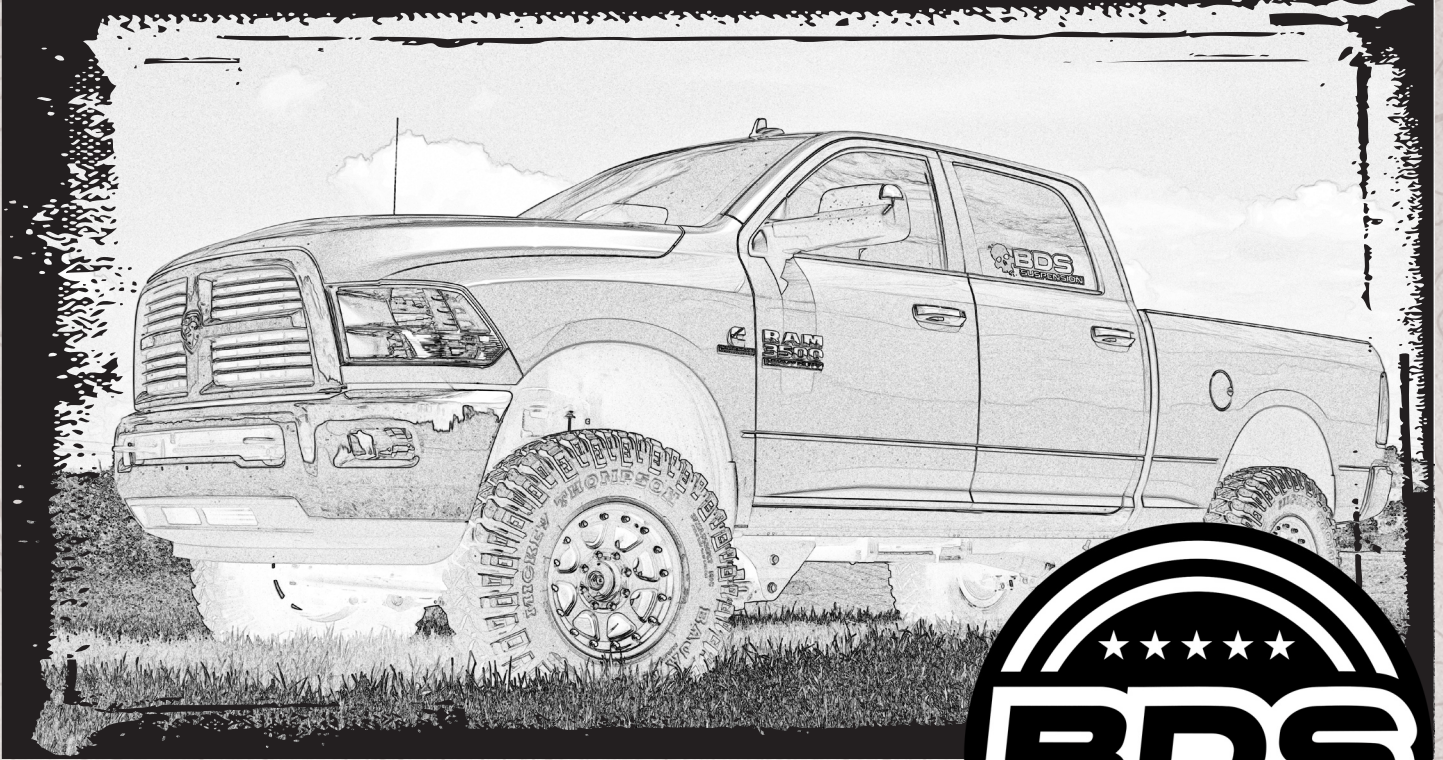

Part#: 122813



**HARDCORE LIMITED LIFETIME WARRANTY**

## 8 Bolt Transfer Case Indexing Ring Kit

Dodge 2500 | 2014-18

Dodge 3500 | 2013-18

Rev. 090325

491 W. Garfield Ave., Coldwater, MI 49036 • Phone: 517-279-2135

Web/live chat: [www.bds-suspension.com](http://www.bds-suspension.com) • E-mail: [tech-bds@ridefox.com](mailto:tech-bds@ridefox.com)



# Read And Understand All Instructions And Warnings Prior To Installation Of System And Operation Of Vehicle.

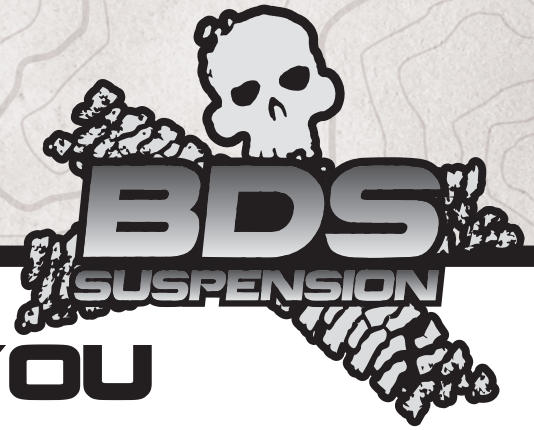

## THANK YOU

Your truck is about to be fitted with the best suspension system on the market today. That means you will be driving the baddest looking truck in the neighborhood, and you'll have the warranty to ensure that it stays that way for years to come. Thank you for choosing BDS Suspension!

### BEFORE YOU START

BDS Suspension Co. recommends this system be installed by a professional technician. In addition to these instructions, professional knowledge of disassembly/ reassembly procedures and post installation checks must be known.

### FOR YOUR SAFETY

Certain BDS Suspension products are intended to improve off-road performance. Modifying your vehicle for off-road use may result in the vehicle handling differently than a factory equipped vehicle. Extreme care must be used to prevent loss of control or vehicle rollover. Failure to drive your modified vehicle safely may result in serious injury or death. BDS Suspension Co. does not recommend the combined use of suspension lifts, body lifts, or other lifting devices. You should never operate your modified vehicle under the influence of alcohol or drugs. Always drive your modified vehicle at reduced speeds to ensure your ability to control your vehicle under all driving conditions. Always wear your seat belt.

### BEFORE INSTALLATION

- Special literature required: OE Service Manual for model/year of vehicle. Refer to manual for proper disassembly/reassembly procedures of OE and related components.
- Adhere to recommendations when replacement fasteners, retainers and keepers are called out in the OE manual.
- Larger rim and tire combinations may increase leverage on suspension, steering, and related components. When selecting combinations larger than OE, consider the additional stress you could be inducing on the OE and related components.
- Post suspension system vehicles may experience drive line vibrations. Angles may require tuning, slider on shaft may require replacement, shafts may need to be lengthened or trued, and U-joints may need to be replaced.
- Secure and properly block vehicle prior to installation of BDS Suspension components. Always wear safety glasses when using power tools.
- If installation is to be performed without a hoist, BDS Suspension Co. recommends rear alterations first.
- Due to payload options and initial ride height variances, the amount of lift is a base figure. Final ride height dimensions may vary in accordance to original vehicle attitude. Always measure the attitude prior to beginning installation.



Visit [560plus.com](http://560plus.com) for more information.

### BEFORE YOU DRIVE

Check all fasteners for proper torque. Check to ensure for adequate clearance between all rotating, mobile, fixed, and heated members. Verify clearance between exhaust and brake lines, fuel lines, fuel tank, floor boards and wiring harness. Check steering gear for clearance. Test and inspect brake system.

Perform steering sweep to ensure front brake hoses have adequate slack and do not contact any rotating, mobile or heated members. Inspect rear brake hoses at full extension for adequate slack. Failure to perform hose check/ replacement may result in component failure. Longer replacement hoses, if needed can be purchased from a local parts supplier.

Perform head light check and adjustment.

Re-torque all fasteners after 500 miles. Always inspect fasteners and components during routine servicing.

# CONTENTS OF YOUR KIT

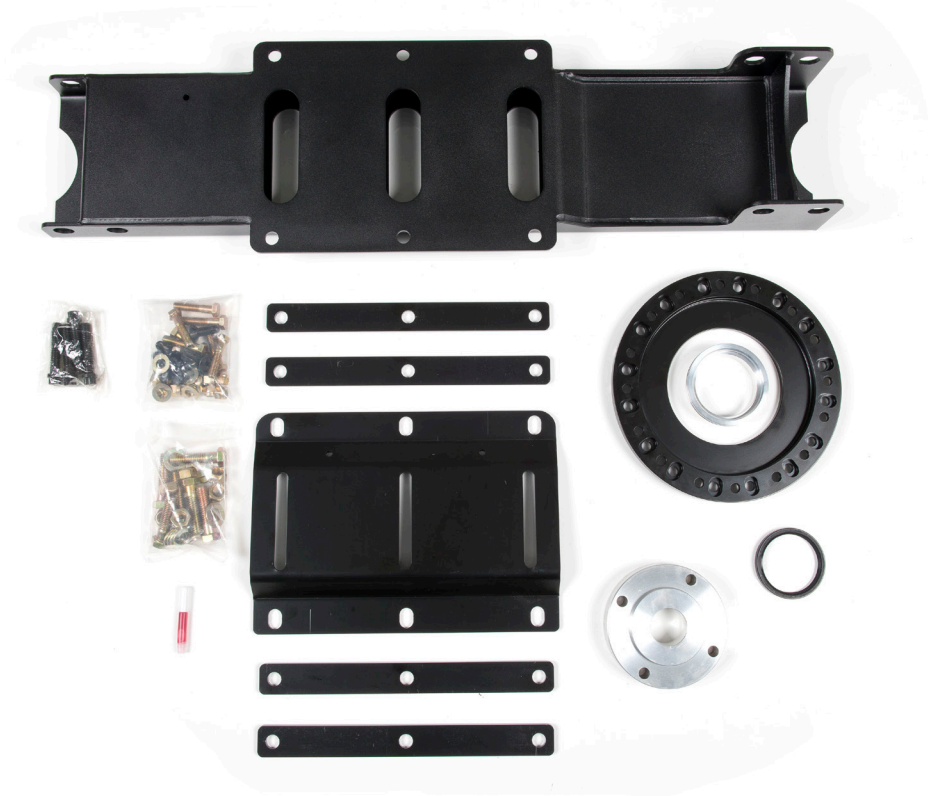

Box Kit		
Part #	Qty	Description
02717	1	Dual Drilled Indexing Ring - Aisin Transmission
UIS63x75x9	1	Transmission Output Seal
02718	1	Transmission Output Seal Extension
02488	1	transmission x-member
02489	1	transmission mount
02490	4	trans mount spacers
02296	1	front driveshaft spacer
099000	4	zip tie
099002	2	x-mas tree zip tie
Thread locker	1	Thread Locker
947	1	Bolt Pack - Aisin Transmission
	8	10mm-1.50 x 30mm flat head allen bolts
	8	3/8"-16 x 1-3/4" bolt
	8	3/8"-16 Nylock Nut
	8	3/8" SAE Washer
944	1	Bolt pack - transmission x-member
	6	1/2"-13 x 2" bolt
	12	1/2" SAE Washer
	6	1/2"-13 Prevailing torque nut
932	1	Bolt pack - front driveshaft spacer
	4	7/16"-14 x 2-1/4" 12 point - flanged head bolt

## TROUBLESHOOTING INFORMATION FOR YOUR VEHICLE

### TECH TIPS

1. BDS Suspension recommends upgrading the transmission output shaft on vehicles with larger tires that will see heavy loads from other upgrades such as gearing, or performance tunes especially in high payload, heavy towing, or competition pulling applications.
2. The front driveshaft dual cardan may need clearanced on vehicles with a large amount of lift. Use a rotary grinding with carbide bit to eliminate any possible interference.
3. Cannot be used on 6-bolt t-case models.
4. **DO NOT USE FILL PORT FOR FLUID LEVEL ON AN INDEXED TRANSFER CASE. THE FILL PORT WILL BE LOWER THAN OE FILL LEVEL HEIGHT:** If any maintenance requiring fluid change or refill has or is being done, before reinstalling transfer case check fluid levels on bench and fill transfer case with manufacturer recommended volume of fluid.

# INSTALLATION INSTRUCTIONS

## INSTALLATION INSTRUCTIONS

 **Tip** *The transmission output seal is replaced with a specific seal only available from BDS, and is included in the kit. The factory seal will not work in the seal adaptor.*

1. Park vehicle on clean, flat, and level surface. Block the rear wheels for safety.
2. Remove the transfer case skid plate if equipped, it will not be reinstalled.
3. Remove the rear driveshaft, retain hardware. Disconnect the front driveshaft from the transfer case. (Fig 1a, 1b)

**FIGURE 1A**



**FIGURE 1B**

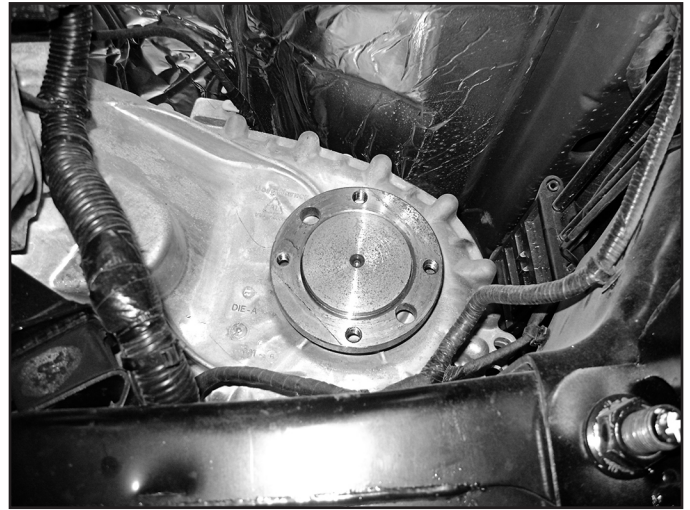

4. Disconnect the wire harness that controls the transfer case. (Fig 2a, 2b)

**FIGURE 2A**



**FIGURE 2B**





5. Disconnect the breather vent tube from the top of the transfer case.
6. Remove the 3 nuts that hold the transmission mount to the transmission crossmember. (Fig 3)

**FIGURE 3**

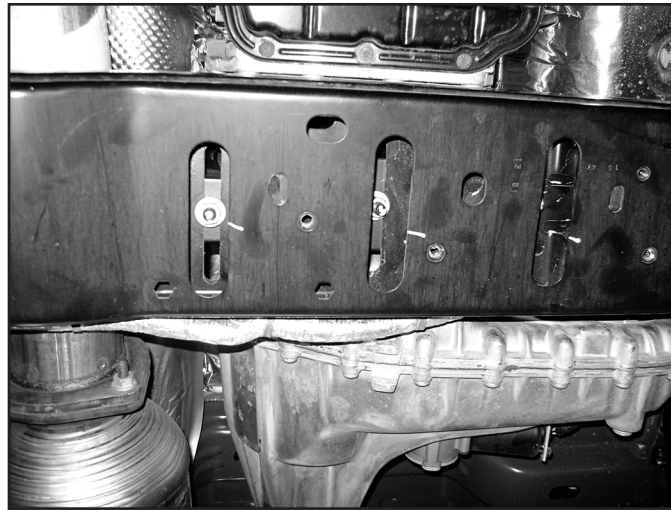

7. Support the transmission with a jack.
8. Remove the transmission crossmember and retain hardware.
9. Remove the mounting brackets that hold the transmission to the crossmember to access all of the transfer case mounting nuts.
10. Manual shift transfer cases: Disconnect the shift linkage from the transfer case, retain all hardware.
11. Remove the 8 nuts that hold the transfer case to the transmission and remove the transfer case from the vehicle. Use extra caution as the transfer case is very heavy.
12. Remove the factory transmission output seal. Install seal into seal adaptor. **\*IMPORTANT\* Lightly grease the new seal \*IMPORTANT\***. Install seal adaptor with new seal into the transmission output housing. (Fig 4a, 4b)

**FIGURE 4A**

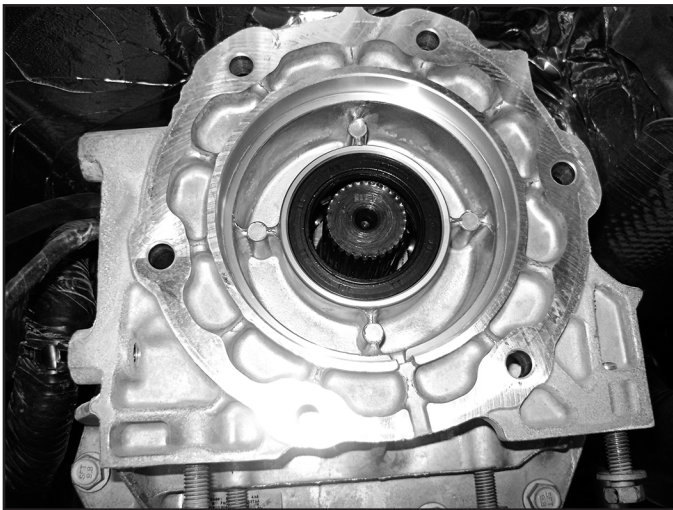
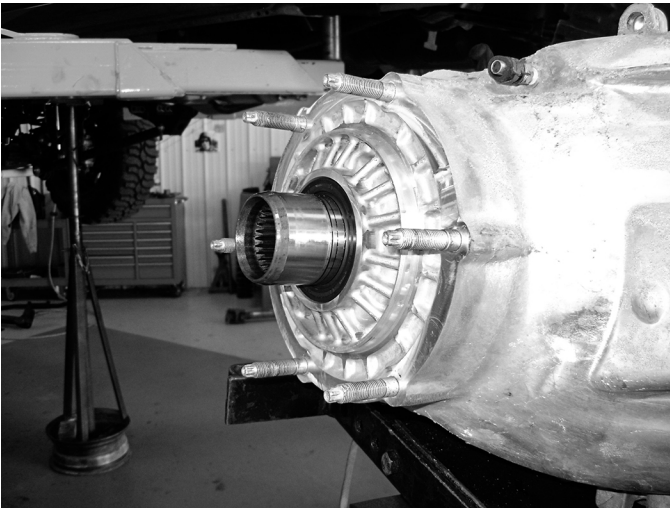

**FIGURE 4B**



13. Remove the 8 studs by double nutting the studs. Place new indexing ring up to the transfer case. There are 2 sets of holes. Use the small spacing (11 degrees) for 6" and smaller kits, larger lift heights will use the large gap (15 degrees). Install the 3/8" bolts into the transfer case into the correct set of holes. Attach with 10mm flat head allen bolts. Figure 5b shows the indexing ring with only one set of holes, use correct indexing based on lift height. It is recommended to use the least amount possible for the application, the indexing ring is labeled on which holes to use. (Fig 5a, 5b, 5c, 5d)

**FIGURE 5A**



**FIGURE 5B**

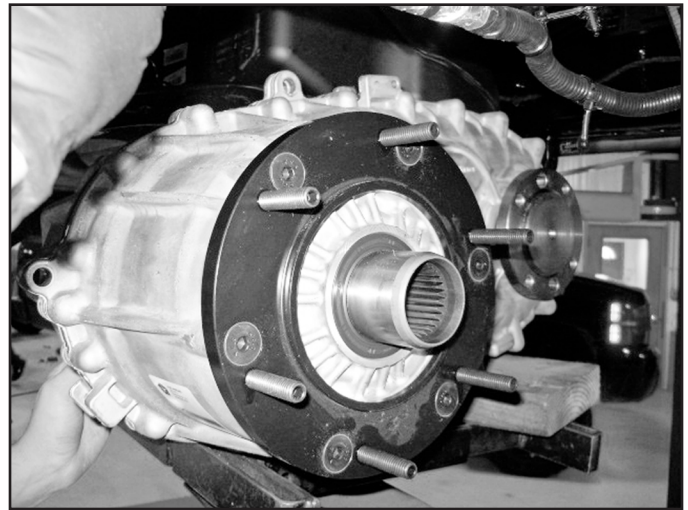

**FIGURE 5C**



**FIGURE 5D**



14. Reinstall the transfer case and tighten with 3/8" nylock nuts with washers. Tighten to 35 ft-lbs.
15. Disconnect the wire harness on the frame rail, reroute the wires to the transmission / transfer case above the front driveshaft. (Fig 6a, 6b)

**FIGURE 6A**



**FIGURE 6B**





 **Tip** Before hooking up the front driveshaft, now is a great time to grease the nearly impossible to access grease fitting on the front dual cardan joint. A needle adaptor on a grease gun is required. This fitting is required to be serviced at every oil change interval. Ensure that this maintenance is not skipped!

16. Reattach the front driveshaft with driveshaft spacer to the transfer case with new 7/16" hardware with thread locker on the threads. Tighten to 75 ft-lbs. (Fig 7)

**FIGURE 7**

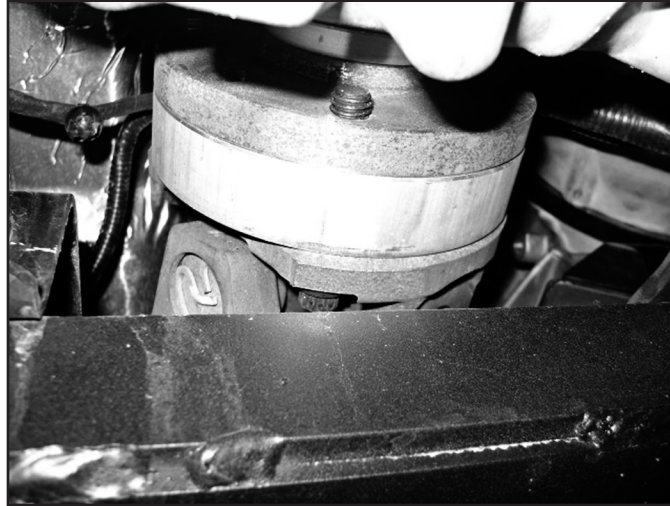

17. Reinstall the transmission mount with factory hardware.
18. Loosely install new base with the factory nuts (3 plc), the taller end of the bracket will face towards the front of the vehicle. (Fig 8)

**FIGURE 8**

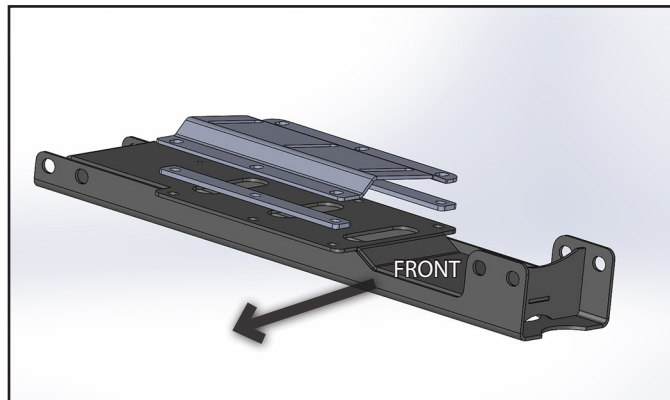

19. Install new crossmember with factory bolts. If this installation is combined with a BDS 4-link kit the nuts will not be put on at this time, and will need to be installed with the 4-link brackets. Otherwise tighten to 150 ft-lbs.
20. There are spacers included with this kit to shim the height of the mount. It is recommended to start with two stacked for 6" kits, adjustments may need to be made if driveline issues become present. Attach the bracket to crossmember with 1/2" hardware (6 places). Lower transmission to the mount and tighten the (3) nuts to 35 ft-lbs, 1/2" hardware 65 ft-lbs. (Fig 9)

**FIGURE 9**



21. Attach the wiring to the transmission crossmember with christmas tree zip ties and secure wires with the other zip ties to retain all wires to keep them clear of any rotating parts or exhaust..
22. Manual Shift Transfer Case: Reconnect the shift linkage to the transfer case. The adjuster may need to be loosened to allow the shift lever to rotate and line up with the linkage on the transfer case (Fig 9A). Additional adjustment may be necessary to get proper engagement in all gear ranges.

**FIGURE 10**

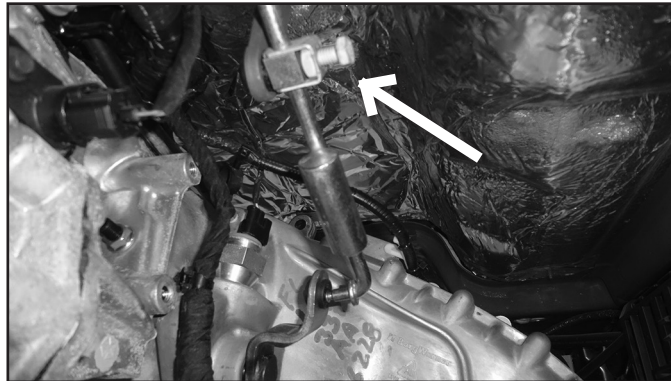

23. When adjusting the shift linkage, it is best to keep the shift linkage in 2wd. Loosen the bolt attaching the rod to the shifter lever going into the cab of the truck (Fig. 9B).
24. Push the transfer case shifter linkage towards the back of the truck, making sure it is still in the correct position (2wd). Next push the shifter linkage going into the cab all the way forward while still making sure it is reading the correct position in the cab (2wd). Tighten the shifter linkage bolt to tighten down the shifter linkage to the rod connecting to the transfer case shifter linkage (Fig 9B). Additional adjustment may be necessary to get proper engagement in all gear ranges.



**FIGURE 11**

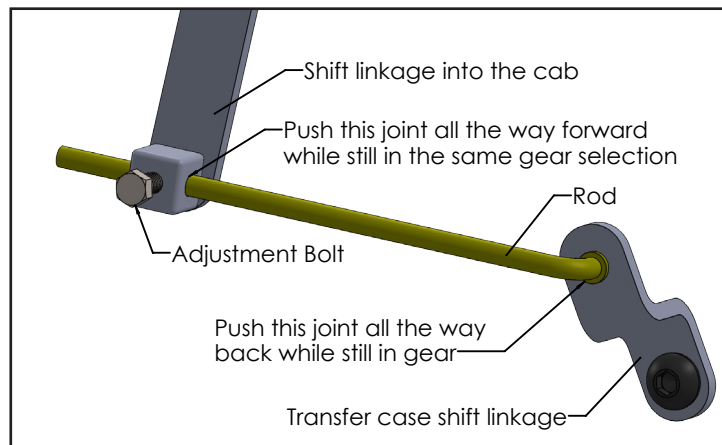

25. Reinstall rear driveshaft with factory hardware with thread locker on threads. Tighten to 75 ft-lbs.
26. Recheck all hardware for proper torque. Check again after 500 miles and at regularly scheduled maintenance intervals.



### **WE WANT TO SEE YOUR RIDE!**

Grab photos of your BDS-equipped truck in action and send them in for a chance to be featured. Send it in to our Bad Ass Rides customer gallery at [bds-suspension.com/bar](http://bds-suspension.com/bar) and post them on the BDS Fan Page on Facebook at [facebook.com/BDSSuspensions](https://facebook.com/BDSSuspensions). Don't forget about your BDS swag! BDS offers t-shirts, hoodies, decals and more available on the BDS website or through your local BDS distributor.

---

## **TIME TO HAVE SOME FUN**

**Thank you for choosing BDS Suspension.**

For questions, technical support and warranty issues relating to this BDS Suspension product, please contact your distributor/installer before contacting BDS Suspension directly.