

INSTALLATION GUIDE

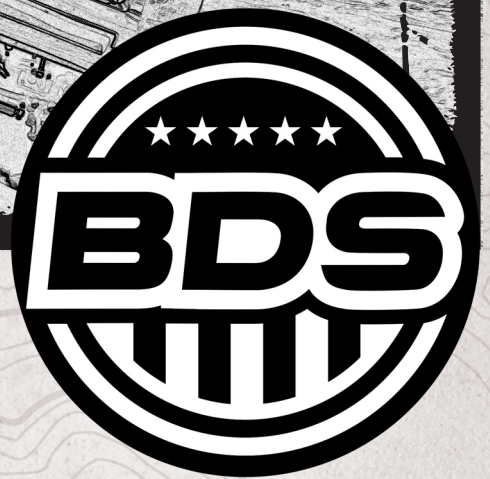

Part#: 012801



HARDCORE LIMITED LIFETIME WARRANTY

6" and 8" Long Travel Suspension System

Dodge Ram 2500 | 2003-2012

Dodge Ram 1500 Mega Cab | 2006-2007

Rev. 011426

491 W. Garfield Ave., Coldwater, MI 49036 • Phone: 517-279-2135

E-mail: tech-bds@ridefox.com

Read And Understand All Instructions And Warnings Prior To Installation Of System And Operation Of Vehicle.



THANK YOU

Your truck is about to be fitted with the best suspension system on the market today. That means you will be driving the baddest looking truck in the neighborhood, and you'll have the warranty to ensure that it stays that way for years to come. Thank you for choosing BDS Suspension!

BEFORE YOU START

BDS Suspension Co. recommends this system be installed by a professional technician. In addition to these instructions, professional knowledge of disassembly/ reassembly procedures and post installation checks must be known.

FOR YOUR SAFETY

Certain BDS Suspension products are intended to improve off-road performance. Modifying your vehicle for off-road use may result in the vehicle handling differently than a factory equipped vehicle. Extreme care must be used to prevent loss of control or vehicle rollover. Failure to drive your modified vehicle safely may result in serious injury or death. BDS Suspension Co. does not recommend the combined use of suspension lifts, body lifts, or other lifting devices. You should never operate your modified vehicle under the influence of alcohol or drugs. Always drive your modified vehicle at reduced speeds to ensure your ability to control your vehicle under all driving conditions. Always wear your seat belt.

BEFORE INSTALLATION

- Special literature required: OE Service Manual for model/year of vehicle. Refer to manual for proper disassembly/reassembly procedures of OE and related components.
- Adhere to recommendations when replacement fasteners, retainers and keepers are called out in the OE manual.
- Larger rim and tire combinations may increase leverage on suspension, steering, and related components. When selecting combinations larger than OE, consider the additional stress you could be inducing on the OE and related components.
- Post suspension system vehicles may experience drive line vibrations. Angles may require tuning, slider on shaft may require replacement, shafts may need to be lengthened or trued, and U-joints may need to be replaced.
- Secure and properly block vehicle prior to installation of BDS Suspension components. Always wear safety glasses when using power tools.
- If installation is to be performed without a hoist, BDS Suspension Co. recommends rear alterations first.
- Due to payload options and initial ride height variances, the amount of lift is a base figure. Final ride height dimensions may vary in accordance to original vehicle attitude. Always measure the attitude prior to beginning installation.



Visit 560plus.com for more information.

TIRES AND WHEELS

6" Kit: 37x12.50 w/ 17x9 with 4.5-5.5" backspacing
8" Kit: 38x13.50 w/ 17x9 with 4.5-5" backspacing



BEFORE YOU DRIVE

Check all fasteners for proper torque. Check to ensure for adequate clearance between all rotating, mobile, fixed, and heated members. Verify clearance between exhaust and brake lines, fuel lines, fuel tank, floor boards and wiring harness. Check steering gear for clearance. Test and inspect brake system.

Perform steering sweep to ensure front brake hoses have adequate slack and do not contact any rotating, mobile or heated members. Inspect rear brake hoses at full extension for adequate slack. Failure to perform hose check/ replacement may result in component failure. Longer replacement hoses, if needed can be purchased from a local parts supplier.

Perform head light check and adjustment.

Re-torque all fasteners after 500 miles. Always inspect fasteners and components during routine servicing.



The kit you are installing may not be exactly as the kit shown.

CONTENTS OF YOUR KIT

122801/122802/122811 T-Case Indexing Kit (8" only)

See separate instruction sheet

012801 Long Arm Box Kit

Part #	Qty	Description
01286B	1	Long Arm Bracket - Drv
01287B	1	Long Arm Bracket - Pass
782	1	Bolt Pack
	10	1/2"-13 x 1-1/2" bolt - grade 8
	10	1/2" SAE thru hardened washer
	2	1/2" External serrated edge washer
	2	5/8"-11 Hex nut
	6	5/8" USS washer
	4	9/16"-12 x 7" bolt - grade 8
	4	14mm-2.00 x 100mm bolt class 10.9
	16	9/16" SAE thru hardened washer
	4	9/16"-12 Prevailing torque nut
	2	3/4"-10 x 5" bolt grade 8
	2	3/4"-10 prevailing torque nut
	4	3/4" SAE flat washer thru-hardened
	4	14mm-2.00 prevailing torque nut
	9	1/2 - 13 Rivet Nut

032801R Front Coil Spring

Part #	Qty	Description
032801R	2	Front Coil Spring - Diesel 8"

012802 Long Arm Box Kit

Part #	Qty	Description
114	4	UCA Sleeve .750 x .095 x 2.33
120	2	LCA Sleeve 1.00 x .1875 x 2.60
121	2	LCA Sleeve 1.00 x 5/32 x 2.60 2010+ only (18mm ID)
7	2	LCA Sleeve 1.00 x .120 x 3.25
60107	8	90 Degree Grease Zerk
01288B	1	Upper Control Arm - Drv
02288B	1	Upper Control Arm - Pass
01289B	2	Lower Control Arm
3522BK	8	UCA Bushing - 3/4" ID
3536BK	4	LCA Bushing - Axle
3527BK	4	LCA Bushing - Frame

012518 Rear Block Kit (3-1/2" axle)

Part #	Qty	Description
02285	2	5in Bump Stop Block
963121412RB	4	9/16 x 3-1/2 x 14-1/2 Round U-bolt
W96S-B	8	9/16 SAE Flat Washer
N96FH-B	8	9/16 Fine High Nut
01599	2	Leaf Pin

012516 Rear Block Kit (4" axle)

Part #	Qty	Description
02285	2	5in Bump Stop Block
01599	2	Leaf Pin
964001614RB	4	9/16 x 4 x 16-1/4 Round U-Bolt
W96S-B	8	9/16 SAE Flat Washer
N96FH-B	8	9/16 Fine High Nut

012408 Rear Block Kit (3-1/2" axle)		
Part #	Qty	Description
02285	2	4in Block
963121412RB	4	9/16 x 3-1/2 x 14-1/2 Round U-bolt
W96S-B	8	9/16 SAE Flat Washer
N96FH-B	8	9/16 Fine High Nut
01599	2	Leaf Pin

6"-012601/8"-012803 Box Kit- 2009+ models

6"-012602/8"-012804 Box Kit- 2008 models

6"-012603/8"-012805 Box Kit- 03-07 models

Part #	Qty	Description
082403R	1	Pitman Arm (03-08)
082404R	1	Pitman Arm (09+)
02258B	1	Track Bar Bracket (03-07)
609	1	Bolt Pack (03-07)
	2	9/16"-12 x 3" bolt grade 8
	4	1/2" USS flat washers thru-hardened
	2	9/16"-12 prevailing torque nut
	1	14mm-2.00 x 80mm bolt class 10.9
	1	9/16" SAE flat washer
02259B	1	Track Bar Bracket (08+)
642	1	Bolt Pack (08+)
	1	9/16"-12 x 3" bolt grade 8
	2	1/2" USS flat washers thru-hardened
	1	9/16"-12 prevailing torque nut
	2	5/8"-11 x 3" bolt grade 8
	4	5/8" SAE flat washer thru-hardened
	2	5/8"-11 prevailing torque nut
01311	2	Sway Bar Link (03-08)
911110	2	Sway Bar Link (09+)
02294B	1	Sway Bar Mount - Drv (03-08)
02295B	1	Sway Bar Mount - Pass (03-08)
02255B	2	Bump Stop Bracket
M02096-BK	2	Urethane Bump Stop
02256	1	Brakeline adaptor - Drv
02257	1	Brakeline adaptor - Pass
02260	2	Steering Stop - Weld On
02129	2	Sway Bar Link U-Bracket
SB58BK	2	5/8" ID Hourglass Bushing
SB35BK	2	3/4" ID Wide Hourglass Bushing
45313	2	.625 x .109 x 1.375 Sleeve
54587	2	.750 x .090 x 1.575 Sleeve
783	1	Bolt Pack - Sway Bar Hardware
	2	5/8"-11 Nylock nut
	3	5/8" SAE Washer
	2	3/8"-16 x 2-1/4" bolt - grade 5
	4	3/8" SAE Thru hardened washer

012405 Rear Block Kit (4" axle)		
Part #	Qty	Description
02285	2	4in Block
01599	2	Leaf Pin
964001614RB	4	9/16 x 4 x 16-1/4 Round U-Bolt
W96S-B	8	9/16 SAE Flat Washer
N96FH-B	8	9/16 Fine High Nut

6"-012601/8"-012803 Box Kit- 2009+ models

6"-012602/8"-012804 Box Kit- 2008 models

6"-012603/8"-012805 Box Kit- 03-07 models

	2	3/8"-16 Prevailing Torque nut
	2	9/16"-12 x 3" bolt - grade 5
	2	9/16"-12 Nylock nut
	5	9/16" SAE washer
	3	1/2"-13 square nut (13/16" width)
	3	1/2"-13 x 1-1/4" bolt - grade 8
	3	1/2" SAE Thru hardened washer
	1	14mm-2.00 x 75mm bolt - class 10.9
	1	16mm-2.00 x 75mm bolt - class 10.9
784	1	Bolt Pack - Misc. Hardware
	4	3/18"-16 x 1-1/4 self tapping screw
	4	3/8"-16 x 2" bolt - grade 5
	6	3/8" SAE Washer
	2	3/8" Split lock washer
	2	3/8"-16 nut - grade 5
	2	5/16"-18 x 1" bolt - grade 5
	4	5/16" SAE Washer
	2	5/16"-18 Nylock nut - grade 5
	1	1/4"-20 x 1" self threading bolt
	1	1/4"-20 x 1" bolt - grade 5
	1	1/4"-20 Nylock nut
	1	1/4" SAE Washer
73	6	1.25 x 5/16 x .875 Sleeve
812	1	Bolt Pack - Bumper Spacer
	6	1/2"-13 x 2" carriage bolts - grade 5
	6	1/2"-13 Nylock nut
	6	1/2" internal tooth washer
	6	1/2" USS washer
	2	5/16"-18 x 1-1/2" self threading bolt
	2	5/16" Fender washer
	2	3/4" SAE washer
01642	1	Rear Brake Line Brkt (03-08)
02422	1	Rear Brake Line Brkt (09-12)
124	1	Rear Brake Line Brkt Spacer (09-12)
02296	1	Front Driveshaft Spacer (6" Box Kits)
932	1	Bolt Pack - Driveshaft (6" Box Kits)

TROUBLESHOOTING INFORMATION FOR YOUR VEHICLE

TECH TIPS

1. Do not put a spacer on top of the coil to get more than 8-inches of lift. You will have driveline and driveability issues.
2. If using this kit with an adjustable front track bar, it MUST be set to factory length. Under full compression the trackbar bracket clears the coil bucket by a small amount. Any variation from the factory length will cause contact.
3. If you have a mega cab model or quad cab long bed, you will need the carrier bearing drop kit (available separately).
4. If you ever need to buy a replacement transmission output seal. The transmission seal you need is from a 48RE transmission. This was found in all automatic transmissions behind the 4wd 5.9 Cummins 03-07. Federal Mogul part # 710058. It has an outside diameter of 2.563". Kits built after 9-10-2010 (R or M code 091210) (month day year) will include the seal.
5. Manual transmission models require T-case indexing ring kit 122802 instead of 122801. Additional front driveshaft clearance at the transmission crossmember may be needed on manual transmission models with the indexing ring installed.
6. A step drill is highly recommended. 11/16" holes are required to be drilled in the installation.
7. If installing optional coilover kit, welding is required, disconnect the battery before you start!
8. 03-08 model year trucks require sway bar relocation brackets at the axle for steering clearance. They are included in the kit. 09+ model years have a different style steering that requires no axle bracket relocation.

INSTALLATION INSTRUCTIONS

SPECIAL TOOLS

1. Park vehicle on clean flat and level surface.
2. Block the wheels for safety.
3. Measure and record the distance from the center of the hub to the bottom of the fender lip. Record below:

Pitman arm puller

Depending on model year kit: Cutoff tools, transmission jack, welder, grinder

Left Front _____

Right Front _____

Left Rear _____

Right Rear _____

4. These instructions cover a complete BDS lift kit installation. If installing a long arm upgrade kit, follow steps 6-14 for the bracket installation and steps 19-24 for the long arm installation. For final control arm torque specifications see the end of the instruction sheet.
5. Disconnect the front trackbar from the frame. Retain hardware. Do this when the vehicle is on the ground. It may be necessary to have an assistant shake the steering wheel back and forth to get the bolt to remove more easily. (Fig 1a)

FIG. 1



8" KITS ONLY - TRANSFER CASE INDEXING RING



Tip

See separate instruction sheet for indexing ring installation.

6" AND 8" LONG ARM BRACKET INSTALLATION (BOLT PACK # 782):

- Support the transmission crossmember with a jack.
- Remove the 4 bolts that hold the transmission crossmember into position (Fig 6a).
- Remove the 4 bolts that attach the front driveshaft to the transfer case. (Fig 7a, 7b)
- Remove transfer case skid plate if equipped. It will not be reinstalled.
- Install long arm bracket to the side of the frame rail around the transmission crossmember mount. Loosely attach with 9/16" x 7" bolts. Mark the top center holes to be drilled. Bolt pack # 782 (Fig 14a, 14b)

FIG. 14A

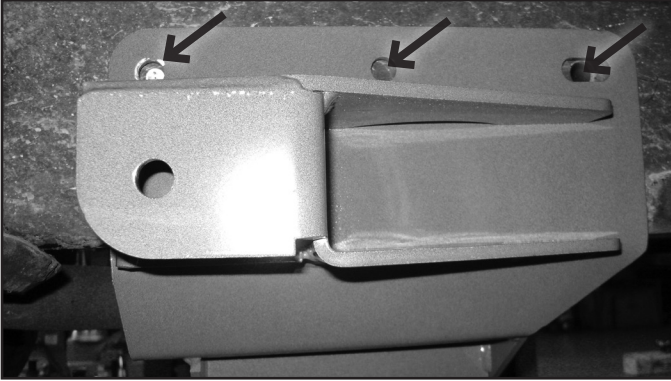
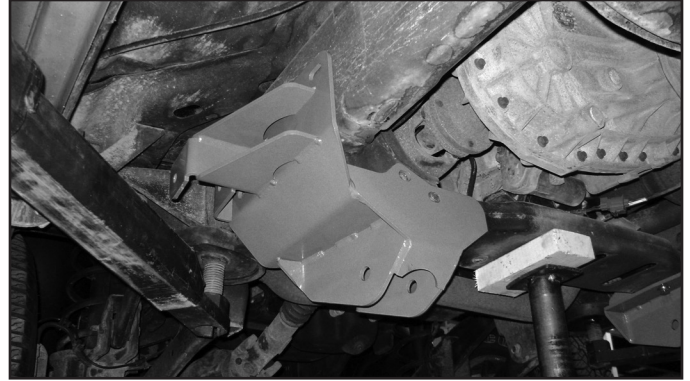

FIG. 14B



- Remove the bracket and drill / clearance holes to 11/16". A step drill is highly recommended.
- Install rivet nuts with serrated edge washer as shown (Fig 15a, 15b, 15c – shows collapsed rivet nut as a reference). The 1/2" bolt goes thru the 5/8" nut with a serrated edge washer that will bite into the rivet nut to keep it from spinning. Tighten until the backside of the rivet nut has been deformed INSIDE THE FRAME RAIL and is set into place (rivet nut will lock itself in place).



Tip

Note: See the end of this instruction sheet for detailed rivet nut installation procedures.

FIG. 15A

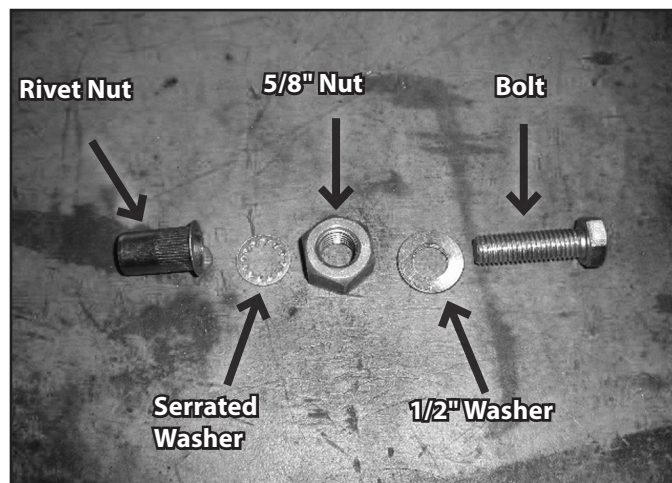
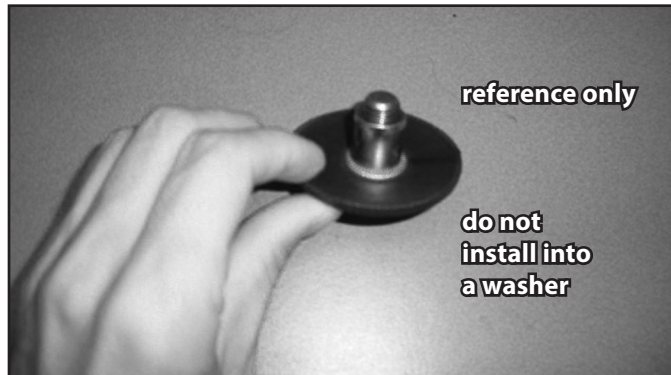

FIG. 15B

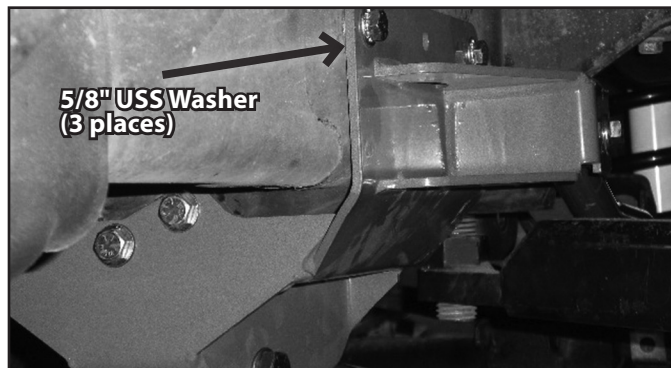

FIG. 15C



13. Reinstall brackets with 9/16" x 7" bolts through the bracket and transmission cross member. Attach to rivet nuts with 1/2" x 1-1/2" bolts with thread locker on threads, use a spacer washer at the 3 locations on outside of the frame rail. Tighten 1/2" hardware to 60 ft-lbs and 9/16" hardware to 95 ft-lbs. (Fig 16)

FIG. 16



14. Repeat for opposite side.
15. Disconnect the drag link from the pitman arm. Do not damage the rubber boot.
16. Disconnect the brakeline bracket from the axle. Retain bolt.
17. Support the front axle. Disconnect the front shocks
18. Lower the front axle and remove the front coils.
19. Grease and install bushings and sleeves into new longer shocks. Install the shocks with OE bolt in the lower mount, and new cup washers and bushings in the upper mount. Thread the upper nut on to get full engagement. The shocks will be removed and reinstalled later. The shocks are designed to carry the weight of the front axle and will allow the axle to move easily to remove and install the control arms.
20. With the axle well supported, remove the upper and lower control arms from the vehicle.

- Grease and install the bushings and sleeves into the lower longer control arms. *note 2003-2009 models require 16mm ID sleeves, 2010 models require 18mm ID sleeves in the axle end of the lower control arm. Install the grease zerks into control arms. All grease fittings are 90 degree fittings, rotate so they will be accessible once installed. (DRV Upper arm shown - Fig 17 & 18)

FIG. 17 - BODY MOUNT CLEARANCE BEND

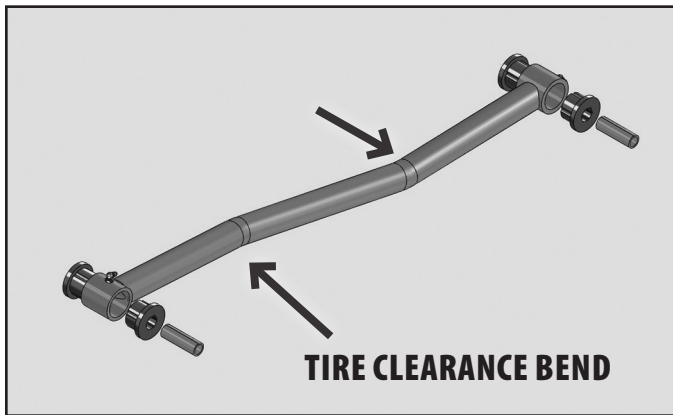

FIG. 18



- Install the upper control arms into the vehicle. Use new 14mm x 100mm bolts for the upper arms at both the bracket and axle. The upper arm will have a clearance bend to clear the tire when the wheel is turned. Run the bolts from outside to inside the vehicle. The Driver's Arm will have a groove machined on the OD of the end that will go in the frame bracket. The main tube will be offset to the bottom side of the arm to give clearance to the body mount.
- Use the factory cam bolt at the axle for the lower control arms. Attach the lower control arm to the relocation bracket with 3/4" x 5" hardware.
- Do not tighten the control arm hardware at this time. It will be done with the vehicle set at ride height.

TRACKBAR / PITMAN ARM INSTRUCTIONS (BOLT PACK # 609 / 642):

- Mark the orientation of the pitman arm. Remove the pitman arm with appropriate tool.
- Transfer mark over to the new pitman arm and reinstall with factory hardware. Tighten nut 150 ft-lbs.
- Attach the tie rod end from the bottom with factory nut. Tighten to 65 ft-lbs. (Fig 19)

FIG. 19



- Install new trackbar bracket with 9/16" (#609 03-07 model years), 5/8" (#642 08+ model years) through the original trackbar mounting hole. Attach the opposite end of the bracket to the frame crossmember with 9/16" x 3" bolt. (Fig 20)

FIG. 20



29. Tighten 9/16" hardware to 95 ft-lbs, 5/8" hardware to 120 ft-lbs.
30. Do not install the trackbar into this bracket at this time.

BUMP STOP INSTRUCTIONS (BOLT PACK # 784):

31. Remove factory bumpstops. It is easiest to take a hammer and hit the bumpstop sideways in order to get them to pop out of the cups, or use a set of channel locks. (Fig 21)

FIG. 21



32. Locate the center of the two circular recesses in the cup. Mark the centers and drill out to 5/16"~21/64". Install the 3/8" x 1-1/4" self threading bolts to cut threads into the frame. Remove the bolts after the threads are cut. BP# 784 (Fig 22)

FIG. 22

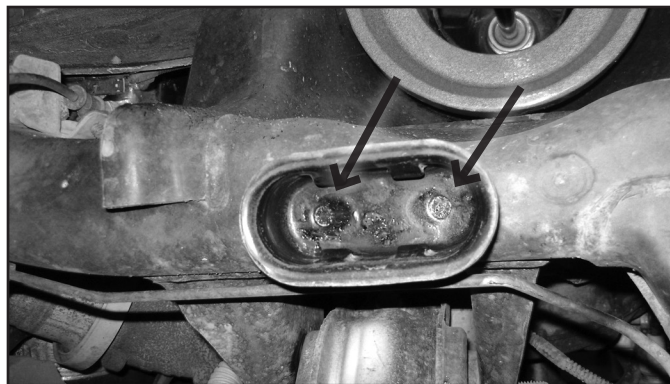

33. Install the new urethane bumpstop into the bumpstop brackets with 3/8" flat washer, lock washer, and nut. Tighten nut securely. Bolt pack #784
34. Install the bumpstop assembly onto the frame with new 3/8" x 2" bolts and washers with thread locker on the threads. Tighten to 35 ft-lbs. (Fig 23)

FIG. 23



SWAY BAR LINK INSTRUCTIONS (SEE SPECIFIC YEAR RANGE INSTRUCTIONS):

2009-2012 MODELS WITH SOLID TIE ROD (T-LINK STEERING SETUP):

35. Grease and install SB35 bushings (longer hour glass bushings with $\frac{3}{4}$ " ID) into one end of the sway bar link with 54587 sleeve ($\frac{3}{4}$ " x $\frac{9}{16}$ " ID x 1.575). Grease and install SB58 (shorter bushings with $\frac{5}{8}$ " ID bushing) into the other end with 45313 sleeve ($\frac{5}{8}$ " x 10mm ID x 1- $\frac{3}{8}$ " long).
36. Attach stem eliminator bracket to the sway bar with $\frac{5}{8}$ " nylock nut with washer. Tighten securely.
37. Install the sway bar link with the small bushings into the stem eliminator bracket with $\frac{3}{8}$ " hardware.
38. Attach the other end of the sway bar link to the axle with $\frac{9}{16}$ " hardware. Run the bolts from inside to the outside of the vehicle. (Fig 24) It may be necessary to slightly clearance the holes to accept the $\frac{9}{16}$ " hardware. 09 and newer models will have left over hardware from bolt pack #783.

FIG. 24



03-08 MODEL YEAR TRUCKS (Y-LINK STEERING):



Tip

Models with y-link steering (03-08 models that have the drag link go from the pitman arm to the passenger's side steering knuckle). This steering does not provide enough clearance to the sway bar mounts, they must be modified. If you have an 03-08 model with the new T-link setup, installation of the brackets is still required due to the length of the sway bar links.

39. Disconnect the tie rod end from one of the steering knuckles and swing the whole assembly out of the way. (Fig 25)

FIG. 25

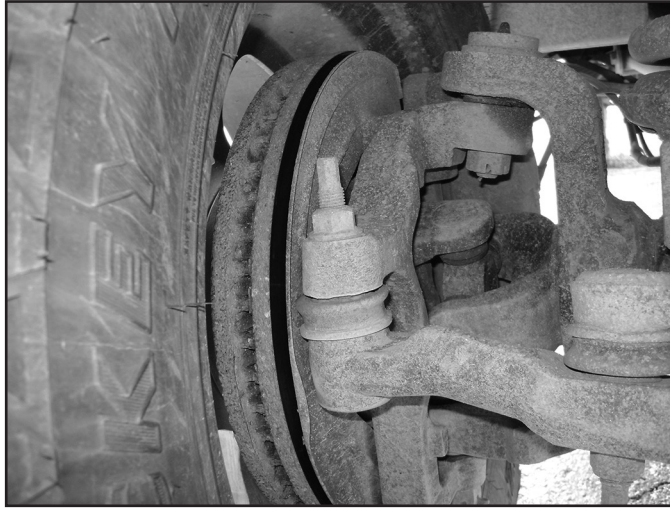

40. Disconnect the trackbar from the axle. Retain nut tab.
41. Cut the welds on both sides of the sway bar link mount at the axle. Remove the brackets from the vehicle.
42. Clean the area with a flap wheel or grinding wheel.
43. Place the sway bar mounting bracket against the axle as shown. The passenger's side will use the factory trackbar hole. Mark and drill the other hole to $\frac{1}{2}$ "~ $17/32$ ".
44. Attach the bracket to the axle with the trackbar in position with new trackbar bolt and washer (14mm 03-07 / 16mm 08+) with factory nut tab, and $\frac{1}{2}$ " bolt (with thread locker), with washer on the outside and square nut on the inside. The square nut will rest against the inside gussets of the axle and eliminate the need for a wrench. Tighten the $\frac{1}{2}$ " hardware to 65 ft-lbs. Do not tighten the trackbar mounting bolt at this time. (Fig 26)

FIG. 26



45. Repeat installation for drivers side. Align the bracket with the existing hole. Mark the opposite hole and drill both holes to $\frac{1}{2}$ "~ $17/32$ ". Reinstall the bracket with $\frac{1}{2}$ " bolts (with thread locker) with washers on the outside and square nuts on the inside of the bracket. Tighten to 65 ft-lbs. (Fig 27)

FIG. 27

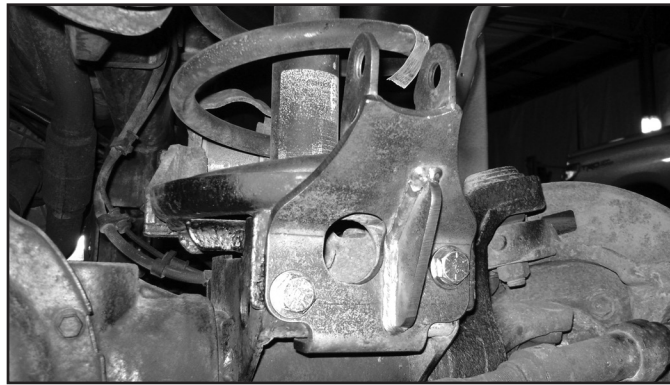

46. Grease and install SB35 (3/4" ID) bushings into one end of the sway bar link with 54587 sleeve (3/4" x 9/16ID x 1.575). Grease and install SB58 (5/8" ID) into the other end with 45313 sleeve (5/8" x 10mm ID x 1.375).
47. Attach stem eliminator bracket to the sway bar with 5/8" nylock nut with washer. Make the brackets parallel to the axle. Tighten securely.
48. Install the sway bar link with the small bushings into the stem eliminator bracket with 3/8" hardware.
49. Attach the other end of the sway bar link to the new axle bracket with 9/16" hardware. Run the bolts from inside to the outside of the vehicle. (See above Fig 24)



Tip

Depending on model year, there will be either an extra 14mm or 16mm bolt leftover from bolt pack #783.

COIL / SHOCK INSTALLATION:



Tip

If installing optional coilovers, see separate instruction sheet for bracket installation - welding is required, don't forget to disconnect the battery.

50. Lower the front axle enough to install the coils. Use care not to overextend the factory brakelines or ABS wires.
51. Install the factory rubber isolator on top of the coils.
52. Install the coil and shock at the same time. Attach the lower shock mount to the axle with factory hardware.
53. Use caution and compress the coil slightly to hook up the upper shock mount.
54. Tighten the upper shock hardware until the bushings begin to swell.
55. Install brakeline relocation brackets to axle with factory hardware. Attach factory brakelines to the relocation brackets with 5/16" x 1" hardware (#784). Tighten to 25 ft-lbs. (Fig 28a, 28b)

FIG. 28A



FIG. 28B



FINAL FRONT STEPS:

56. Reinstall the rear driveshaft with factory hardware (Torque to 75 ft-lbs), use thread locker on threads. If the vehicle is equipped with a carrier bearing, install carrier bearing drop at this time (sold separately).



Tip

Before hooking up the front driveshaft, now is a great time to grease the nearly impossible to access grease fitting on the front dual cardan joint. A needle adaptor on a grease gun is required. This fitting is required to be serviced at every oil change interval. Ensure that this maintenance is not skipped!

57. Reinstall front driveshaft to the transfer case with driveshaft spacer and new hardware. Use thread locker on threads and tighten to 75 ft-lbs. Bolt pack # 932 (Fig 29a, 29b)

FIG. 29A



FIG. 29B



58. Reinstall wheels and tighten lug nuts to factory specifications.
59. Once the front driveshaft has been re-installed, Lower the vehicle to the ground.
60. Tighten control arm hardware as follows: 14mm upper arm hardware 120 ft-lbs, 3/4" Lower at frame 160 ft-lbs, 16mm cam bolt at axle 160 ft-lbs (03-09 models only), 18mm cam bolt at axle 180 ft-lbs (2010+ models only).
61. Attach the trackbar to the relocation bracket with 14mm hardware (03-07) or 5/8" hardware (08+). Tighten 14mm hardware to 120 ft-lbs at axle and relocation bracket. Tighten 5/8" hardware to 150 ft-lbs.

REAR INSTALLATION

62. 2003-11 Models: Drill the hole in the brakeline bracket at the frame to 1/4"~5/16"
63. 2003-11 Models: Use extreme caution around the fuel tank. Cut the factory brakeline bracket with a sawzall. Do not use any method that will create sparks. (Fig 30a, 30b)

FIG. 30A

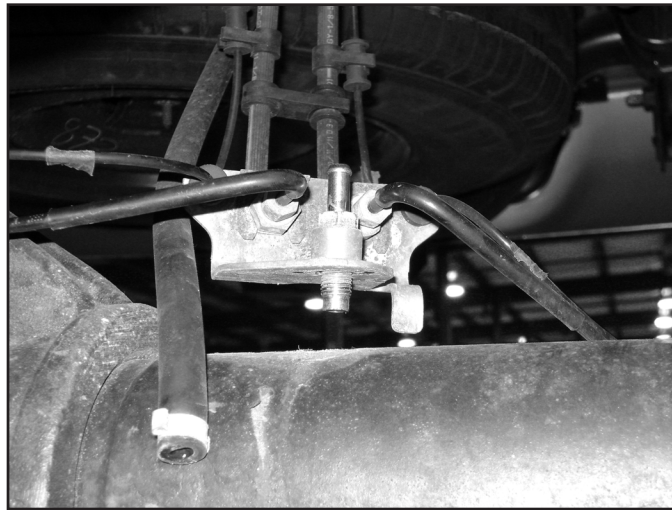

FIG. 30B



64. 2003-11 Models: Reform the brakeline to aim down towards the axle.
65. 2012 Models: Disconnect the rear brake line bracket from the axle by removing the vent line. (Fig 30c)

FIG 30C



66. Disconnect parking brake guide bracket on side of frame and remove from vehicle, it will not be reused. (Fig 31)

FIG. 31



67. Disconnect the parking brake cable by unthreading nut with 13mm ratchet wrench.
68. Disconnect the cable completely from the junction in front of the rear spring hanger. Reroute the cable to the inside of the leaf spring hanger as shown to give more slack at full droop. (Fig 32a & 32b)

FIG. 32A

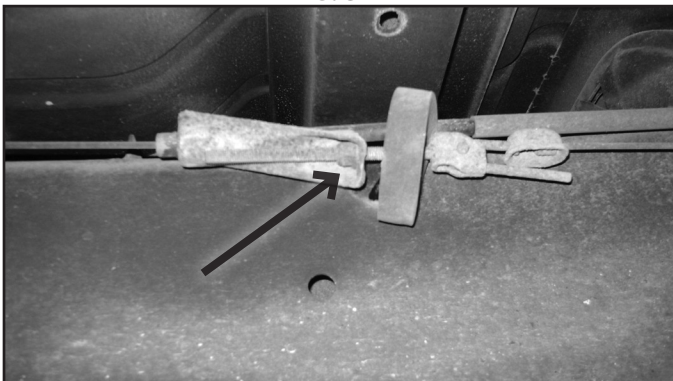

FIG. 34B



69. Support the axle.
70. Disconnect the shocks, retain hardware.

71. Remove the passenger side factory u-bolts and lower axle.
72. If installing new leaf springs, remove the spring from the vehicle and replace with the BDS leaf spring so the shorter side that is labeled front is towards the front of the vehicle.
73. If installing rear lift blocks, install the new press in center pin into the leaf pack.
74. Install the new lift blocks if the lift block has a bump stop wing face it 'in' towards the center of the vehicle. If it Tapered face the short end forward.
75. Align the pins and install into the axle perch.
76. Install new u-bolts. Snug but do not tighten at this time.
77. Repeat leaf spring or block and pin installation on opposite side of the vehicle.
78. Grease and install bushings and sleeves into the new shocks. Install the shocks with factory hardware.
79. 2003-11 Models: Adjust the brakeline bracket at the frame to give adequate slack at full droop.
80. 2003-11 Models: Attach the brakeline relocation bracket to the factory bracket. Form bracket to rest against the frame. Mark the hole center and drill out to 7/32". (Fig 33a)

FIG. 33A

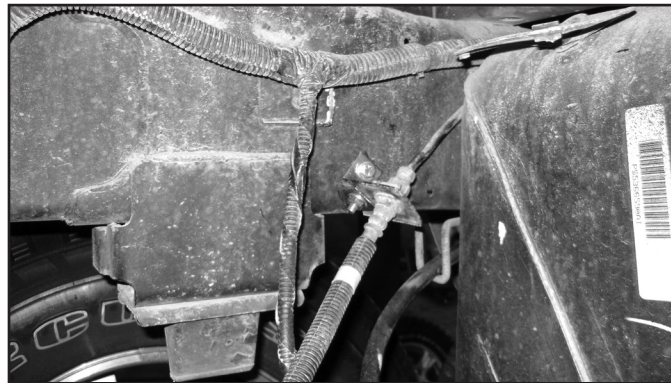

81. 2003-11 Models: Attach 'L' bracket to the frame with 1/4"x1" Self threading bolt. Attach brakeline bracket to 'L' bracket with 1/4" x 1" hardware. Tighten to 15 ft-lbs. (#784).
82. 2012 Models: Remove the brake line bracket from the lines. This can be done by cutting slots in the bracket with a small cut-off wheel to avoid disconnecting the lines.
83. 2012 Models: Install the provided brake line relocation bracket with the provided sleeve and factory vent bolt. Reform the lines to line up with the bracket and attach them with the factory clips.

FIG 33B



84. Lower vehicle and tighten u-bolts to 125 ft-lbs.

BUMPER SPACER & PINCH WELD MODIFICATION FOR 38" TIRES (BOLT PACK # 812)

85. Disconnect the fog light wiring harness (if equipped).
86. Remove the 6 bolts (3 per side) that attach the bumper to the frame horns. Later model trucks (2010-2012) may have 4 bolts per side, the top inside one is next to impossible to access, we do not provide replacement hardware for this position. Installing 3 bolts per side will be the same as early model (03-09) model year trucks.
87. Knock out the carriage bolts from the bumper.
88. Install new carriage bolts with retaining clips on the outer 2 positions. Install carriage bolt into the center positions without a retaining clip. (Fig 34a, 34b)

FIG. 34A

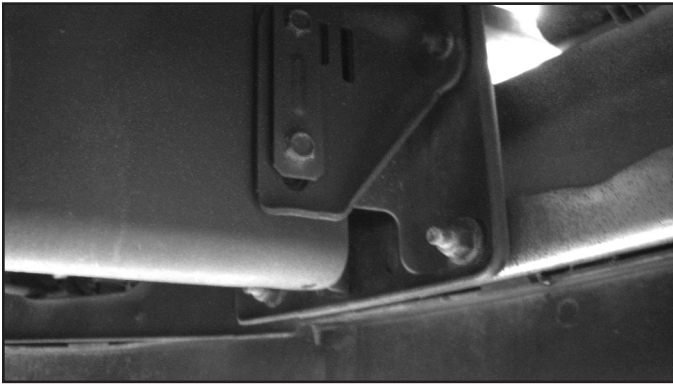
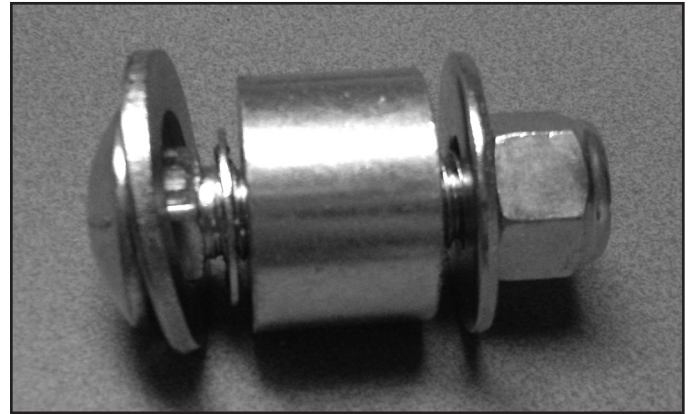

FIG. 34B



89. Install bumper onto vehicle with spacers over the carriage bolts. There are 2 bolts that will need to have a $\frac{3}{4}$ " washer added under the head. These bolts only go through one layer of the bumper. The rest of the bolts do not need a washer under the head of the carriage bolt.
90. Adjust bumper so that it sits even.
91. Tighten $\frac{1}{2}$ " carriage bolts to 55 ft-lbs.
92. Reconnect the fog light wiring harness.
93. The front plastic inner fender well needs to be removed. Bend over the pinch weld and trim 4 inches from the bottom of the foam insulation.
94. Reinstall plastic inner fender well, but do not attach the lower rear mount to the body.
95. Mark and drill a $\frac{1}{4}$ " ~ $\frac{17}{64}$ " hole thru the inner fender well into the body. Attach the plastic inner fender well with $\frac{5}{16}$ " self threading bolt with a fender washer. This will give more clearance for larger sized tires, additional trimming on the bottom of the plastic may be required.
96. Place the inner fender well to the 'front' side of the bumper.
97. Perform a steering sweep to ensure there is enough clearance. If the tires rub on the upper control arm different wheels and tires may be required. If desired to not change the wheels and tires, disconnect the battery and weld on the steering stops. (Fig 35)
98. Check the shift linkage for manual shift transfer cases. Adjust the linkage as necessary to allow all gear ranges to be selected.
99. Recheck all fasteners for proper torque.

FIG. 35

DETAILED RIVET NUT INSTALLATION INSTRUCTIONS

RIVET NUT SIZING

100. Verify the correct size rivet nut for the application based on the thickness of material where the rivet nut is to be installed using the following chart.

Part Number	Thread Size	Body Length (in)	Material Thickness (in)		Drill Size (in)
			Min.	Max.	
95105A159	3/8-16	.690	.027	.150	17/32
95105A168	3/8-16	.805	.150	.312	17/32
95105A169	1/2-13	1.150	.063	.200	11/16
95105A170	1/2-13	1.300	.200	.350	11/16

HOLE PREPARATION

101. Drill hole to appropriate size for rivet nut installation. 1/2" Rivnuts require an 11/16" hole and 3/8" Rivnuts require a 17/32" drill. It is critical that this hole is drilled to the correct size. Remove any burrs that could keep the rivet nut from seating flat against either side of the hole surface.



Tip

If the correct drill size is not available, it is possible to drill the hole to an available smaller size and slowly grind it out to until the rivet nut fits tight.

RIVET NUT INSTALLATION TOOL ASSEMBLY

102. For a 3/8" rivet nut, place the provided 3/8" SAE flat washer on the 3/8" x 1-1/2" bolt, followed by 7/16" hex nut and then a 3/8" serrated washer. Thread this tool assembly into the rivet nut.

103. For a 1/2" rivet nut, place the provided 1/2" SAE washer on a 1/2" bolt followed by a 5/8" nut and 1/2" serrated edge lock washer. Thread this tool assembly into the rivet nut.

RIVET NUT INSTALLATION

104. Place the installation tool with the rivet nut threaded on the end into the appropriately sized hole.

105. For a 3/8" rivet nut, hold the nut closest to the rivet nut still with an 5/8" wrench and tighten the 3/8" bolt with a 9/16 wrench to set the rivet nut. Be sure to hold the rivet nut flush to the surface and square to the hole as it is tightened. (Fig 1)



Tip

If available, an impact gun is recommended for tightening the bolt to ensure the rivet nut remains square to the hole and to ease holding the nut from spinning.

106. For a 1/2" rivet nut, hold the nut closest to the rivet nut still with a wrench and tighten the 1/2" bolt with a 3/4" wrench or impact gun to set the rivet nut. Be sure to hold the rivet nut flush to the surface and square to the hole as it is tightened. (Fig 2)

FIGURE 1 - 1/2" RIVET NUT SHOWN



TORQUE SPECIFICATIONS

107. 3/8" rivet nuts will approach 40 ft. lbs for maximum grip strength. Do not exceed 45 ft-lbs when setting the rivet nut.
108. 1/2" rivet nuts will approach 90 ft lbs for maximum grip strength. Do not exceed 100 ft-lbs when setting the rivet nut.



Tip

If using the recommended impact gun, use caution to not exceed the recommended torque specifications.

RIVET NUT TOOL REMOVAL

109. Once the center bolt is tightened, remain holding the nut from spinning with the wrench and loosen the center bolt to remove the installation tool.



Caution

It is very important to hold the nut as the bolt is loosened because the grip of the star washer will try to spin the rivet nut and ruin the installation.

110. Verify proper installation by checking for consistent rivet nut deformation to see the threads are square and centered to the rivet nut. (Fig 2).

FIGURE 2





WE WANT TO SEE YOUR RIDE!

Grab photos of your BDS-equipped truck in action and send them in for a chance to be featured. Send it in to our Bad Ass Rides customer gallery at bds-suspension.com/bar and post them on the BDS Fan Page on Facebook at facebook.com/BDSSuspensions. Don't forget about your BDS swag! BDS offers t-shirts, hoodies, decals and more available on the BDS website or through your local BDS distributor.

TIME TO HAVE SOME FUN

Thank you for choosing BDS Suspension.

For questions, technical support and warranty issues relating to this BDS Suspension product, please contact your distributor/installer before contacting BDS Suspension directly.