

INSTALLATION GUIDE



Part#: 012614



HARDCORE LIMITED LIFETIME WARRANTY

5.5" Gas & 6" Diesel

Radius Arm Suspension System

Dodge Ram 3500 4WD Pickup | 2019-2024

Dodge Ram 2500 4WD Pickup | 2019-2026

491 W. Garfield Ave., Coldwater, MI 49036 • Phone: 517-279-2135

Web: www.bds-suspension.com • E-mail: tech-bds@ridefox.com

Rev. 102425

Read And Understand All Instructions And Warnings Prior To Installation Of System And Operation Of Vehicle.



THANK YOU

Your truck is about to be fitted with the best suspension system on the market today. That means you will be driving the baddest looking truck in the neighborhood, and you'll have the warranty to ensure that it stays that way for years to come. Thank you for choosing BDS Suspension!

BEFORE YOU START

BDS Suspension Co. recommends this system be installed by a professional technician. In addition to these instructions, professional knowledge of disassembly/ reassembly procedures and post installation checks must be known.

FOR YOUR SAFETY

Certain BDS Suspension products are intended to improve off-road performance. Modifying your vehicle for off-road use may result in the vehicle handling differently than a factory equipped vehicle. Extreme care must be used to prevent loss of control or vehicle rollover. Failure to drive your modified vehicle safely may result in serious injury or death. BDS Suspension Co. does not recommend the combined use of suspension lifts, body lifts, or other lifting devices. You should never operate your modified vehicle under the influence of alcohol or drugs. Always drive your modified vehicle at reduced speeds to ensure your ability to control your vehicle under all driving conditions. Always wear your seat belt.

BEFORE INSTALLATION

Special literature required: OE Service Manual for model/year of vehicle. Refer to manual for proper disassembly/reassembly procedures of OE and related components.

Adhere to recommendations when replacement fasteners, retainers and keepers are called out in the OE manual.

Larger rim and tire combinations may increase leverage on suspension, steering, and related components. When selecting combinations larger than OE, consider the additional stress you could be inducing on the OE and related components.

Post suspension system vehicles may experience drive line vibrations. Angles may require tuning, slider on shaft may require replacement, shafts may need to be lengthened or trued, and U-joints may need to be replaced.

Secure and properly block vehicle prior to installation of BDS Suspension components. Always wear safety glasses when using power tools.

If installation is to be performed without a hoist, BDS Suspension Co. recommends rear alterations first.

Due to payload options and initial ride height variances, the amount of lift is a base figure. Final ride height dimensions may vary in accordance to original vehicle attitude. Always measure the attitude prior to beginning installation.

BEFORE YOU DRIVE

Check all fasteners for proper torque. Check to ensure for adequate clearance between all rotating, mobile, fixed, and heated members. Verify clearance between exhaust and brake lines, fuel lines, fuel tank, floor boards and wiring harness. Check steering gear for clearance. Test and inspect brake system.

Perform steering sweep to ensure front brake hoses have adequate slack and do not contact any rotating, mobile or heated members. Inspect rear brake hoses at full extension for adequate slack. Failure to perform hose check/ replacement may result in component failure. Longer replacement hoses, if needed can be purchased from a local parts supplier.

Perform head light check and adjustment.

Re-torque all fasteners after 500 miles. Always inspect fasteners and components during routine servicing.

TIRES AND WHEELS

FITMENT GUIDE

6" Lift:

37x12.50 w/ 4.5~5.625" Backspacing on 9" wide wheel

37x13.50 w/ 5.625" Backspacing on 9" wide wheel



CONTENTS OF YOUR KIT

012614		
<i>Part #</i>	<i>Qty</i>	<i>Description</i>
082405R	1	Pitman Arm
03816	1	Trackbar bracket
27031	1	Fish Wire
03855	1	Brake Bracket - DRV
03856	1	Brake Bracket - Pass
099000	2	Zip Ties
86-6277	1	CV Joint Boot Clamp
86-6276	1	CV Joint Boot Clamp
01253b	1	Sway Bar Drop - DRV
01254b	1	Sway Bar Drop - Pass
03964	4	Cam Plate
494	1	Bolt Pack
	2	14mm-2.00 x 35mm Bolt, Clear Zinc
	4	14mm Washer, Clear Zinc
	2	14mm-2.00 Prevailing Torque Nut, Clear zinc
495	1	Bolt Pack
	2	1/4" USS Washer, Clear Zinc
	2	5/16"-18 Lock Nut, Clear Zinc
422	1	Bolt Pack
	4	3/8"-16 x 1-1/4" Bolt, Yellow Zinc
	4	3/8" Washer, Yellow Zinc
	4	3/8"-16 Prevailing Torque Nut, Yellow Zinc
358	1	Bolt Pack
	2	18mm-2.50 x 140mm, Clear Zinc
	4	18mm Washer, Clear Zinc
	2	18mm-2.50 Prevailing Torque Nut, Clear Zinc

032602		
<i>Part #</i>	<i>Qty</i>	<i>Description</i>
032602R	2	Coil Spring (Diesel)

032491		
<i>Part #</i>	<i>Qty</i>	<i>Description</i>
032401R	2	Coil Spring (Gas)

122321		
<i>Part #</i>	<i>Qty</i>	<i>Description</i>
A243	1	Radius Arm - Drv
A244	1	Radius Arm - Pass

Front Shocks		
<i>Part #</i>	<i>Qty</i>	<i>Description</i>
85752	2	Front NX2 Shock (Diesel)
or		
98224752	2	Front Fox 2.0 (Diesel)

INSTALLATION INSTRUCTIONS

PRE INSTALLATION NOTES:

6.4L Gas models will require extensive exhaust modification to clear the front driveshaft. The vehicle can be driven without the front driveshaft to an exhaust shop for modification and reinstalled after modification.

Separate instructions are provided with the Index Ring & Rear Box kits.

SPECIAL TOOLS

- #1: Pitman arm puller
- #2 CV style clamp pliers

MEASURE FIRST

Measure from the center of the wheel up to the bottom edge of the wheel opening:

LF _____ RF _____

LR _____ RR _____

RADIUS ARM INSTALLATION INSTRUCTIONS

1. Park the vehicle on clean flat and level surface. Block the rear wheels for safety.
2. Remove the front trackbar bolt from the frame rail. Retain all hardware. (Fig. 1)

FIGURE 1

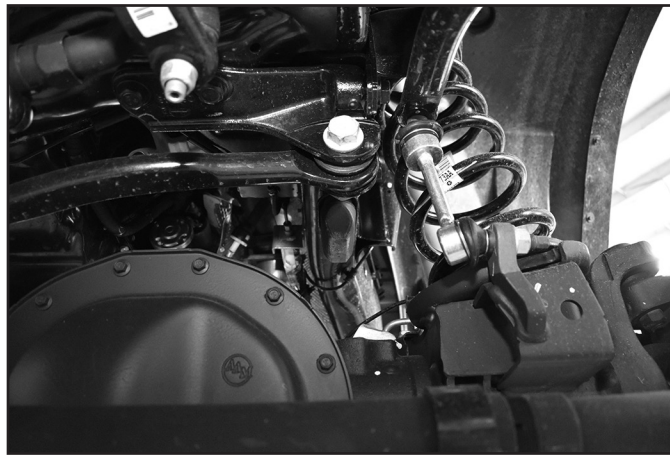

3. Raise the front of the vehicle and support the frame rails with jackstands. Do not support the vehicle by the radius arms, they will be removed during the installation.

SUSPENSION DISASSEMBLY

4. Support the front axle with a hydraulic jack.
5. Remove the factory wheels, remove the retaining clips that hold the rotor on and may interfere with aftermarket wheels.
6. Disconnect the front drive shaft from the front axle. Hang the drive shaft from the frame. Retain all hardware
7. Break the nut loose on the adjusting sleeve of the drag link. (Fig 2)

FIGURE 2

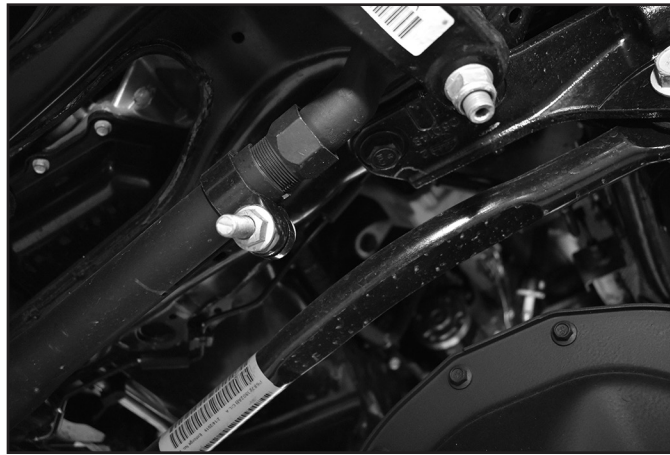

8. Disconnect the drag link tie rod from the pitman arm, do not damage the tie rod boot. Mark the orientation of the pitman arm and remove the pitman arm from the sector shaft. (Fig. 3)

FIGURE 3

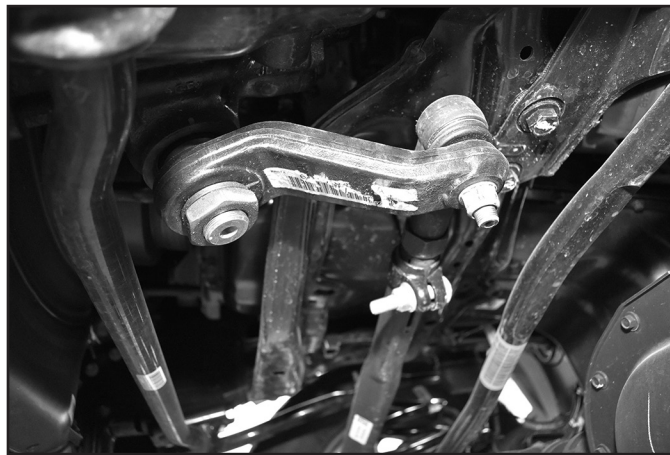

9. Disconnect the sway bar links from the sway bar. Retain all hardware. (Fig. 4)

FIGURE 4



10. Disconnect the brake line bracket from the top of the radius arm mount on the axle. (Fig. 5)

FIGURE 5

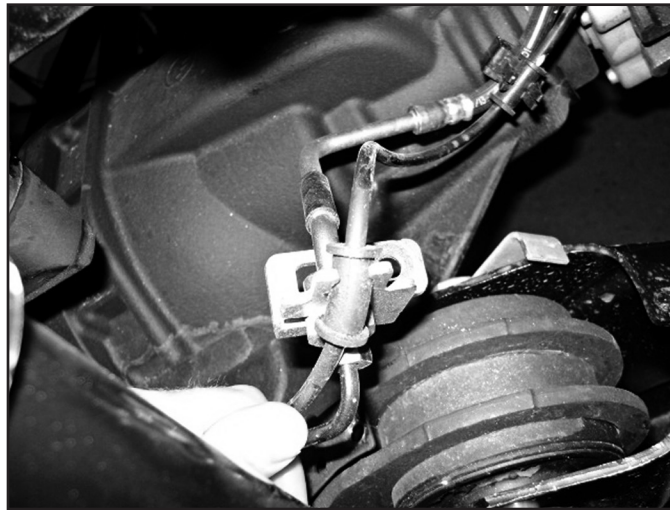

11. Detach the ABS and Central Axle Disconnect wires from retaining clips to allow for extra slack when the new coils will be installed.
12. Support the front axle with a hydraulic jack.
13. Disconnect the shock hardware at the lower and upper mounts; keep the lower bolt and nut tab. Remove the shocks. (Fig 6)

FIGURE 6



14. Lower the axle and remove the factory coils. Use care not to overextend any brake line, ABS, or CAD wires.

RADIUS ARM INSTALLATION:

15. Working on one side of the vehicle at a time, remove the factory radius arm. Retain all hardware.
16. Replace the radius arm with the new one, both sides are the same. Reattach with factory hardware at the frame and upper axle mount. Replace the cam bolt with the 18mm bolt supplied in bolt pack 358 and provided cam plates. Insert the cam plates so the bolt is as far forward as possible. (Fig 7A Passenger side shown) Note: This will provide more caster than the factory cam bolts allow. Remove one of the opposing bolts at the axle to allow the axle to rotate while supporting it with a jack. (Fig 7B)

FIGURE 7A

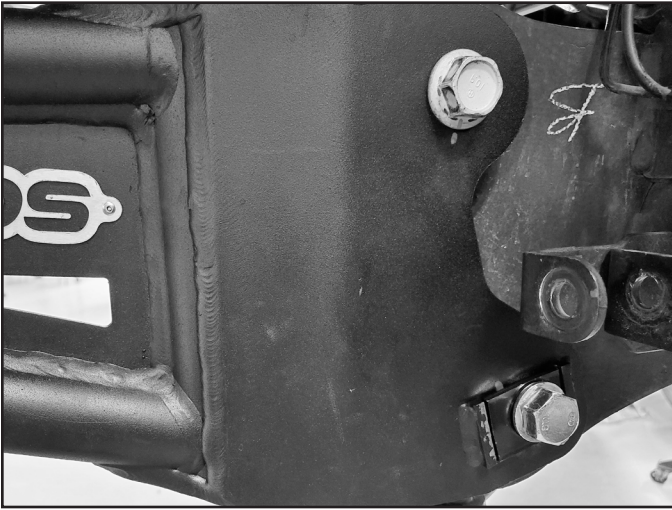
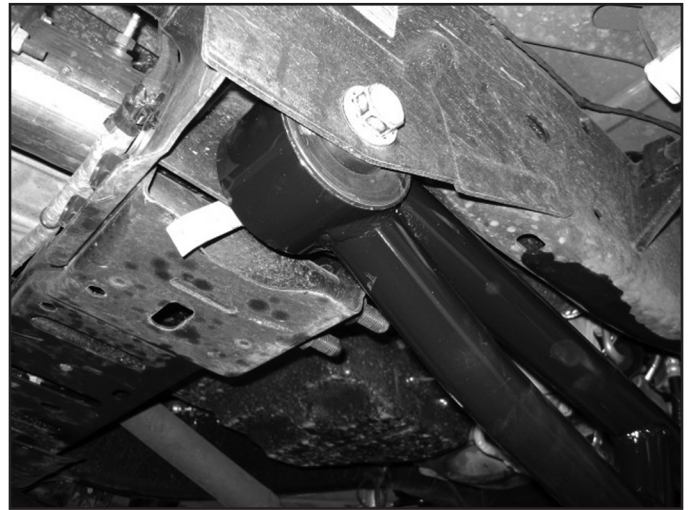

FIGURE 7B



17. Repeat radius arm installation on opposite side.
18. Tighten the upper bolt at the axle to 133 ft-lbs plus 90deg. Tighten the provided 18mm bolt to 270 ft-lbs Do not tighten the pivot bushing hardware at the frame at this time.

BUMP STOP INSTALLATION:

19. Remove the factory bump stops, it is easiest to hit them from the side with a hammer to pop them out. (Fig. 8)

FIGURE 8



20. Grease new replacement bump stops and raise axle to press the bump stops into position. These will be a tight fit. It is easiest to lift the axle with a jack to compress the bump stops into position. (Fig. 9)

FIGURE 9



TRACK BAR BRACKET INSTALLATION

21. Remove the factory track bar bracket, retain the vertical hardware that goes into the cross member.
22. Install the provided trackbar bracket with factory bolts through the original vertical trackbar bracket holes in the crossmember, do not tighten.
23. Use the provided 14mm hardware in bolt pack 494, Bolt the new trackbar bracket to the Frame tab with the nut on the inside of the frame tab. Use OE hardware in the 3 remaining holes. Torque the OE bolts to 118 ft-lbs and provided 14mm hardware to 148.4 ft-lbs. (Fig 10)

FIGURE 10

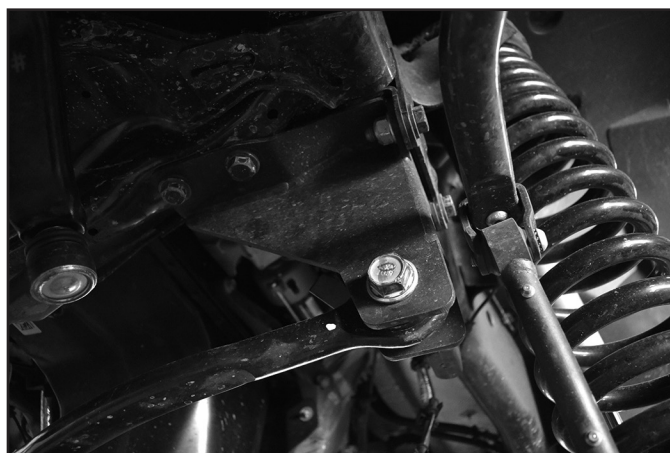

24. **6" Diesel:** Lower the axle and install the new coils with factory isolator. The end of the spring with the windings closer together will go at the top, do not install upside down. The passenger's side upper mount will need to be reindexed. There is a template at the end of the instruction sheet. Cut this out and place over the passenger's side upper mount, mark the center of the hole, and drill to 1/2". The hole should now be directly to the 'Rear' of the vehicle. Install isolator with the new coil spring. Ensure that coils are seated properly, have someone help if necessary. (Fig 11a, 11b, 12a, 12b)

FIGURE 11A



FIGURE 11B



FIGURE 12A



FIGURE 12B



25. **5.5" Gas:** Lower the axle and install the new coils with factory isolator. The end of the spring with the windings closer together will go at the top, do not install upside down. The passenger's side upper mount will need to be reindexed. There is a template at the end of the instruction sheet. Cut this out and place over the passenger's side upper mount, mark the center of the hole, and drill to 1/2". The hole should now be directly to the 'Outside' of the vehicle. Install isolator with new coil spring. Ensure that coils are seated properly, have someone help if necessary. (Fig 13a, 13b, 14a, 14b)

FIGURE 13A



FIGURE 13B

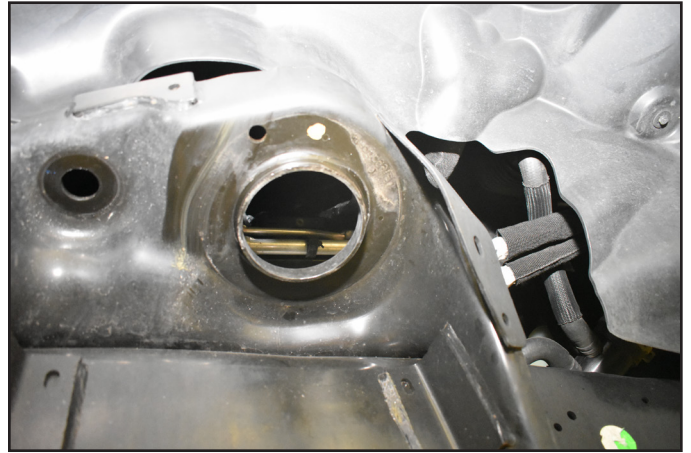

FIGURE 14A

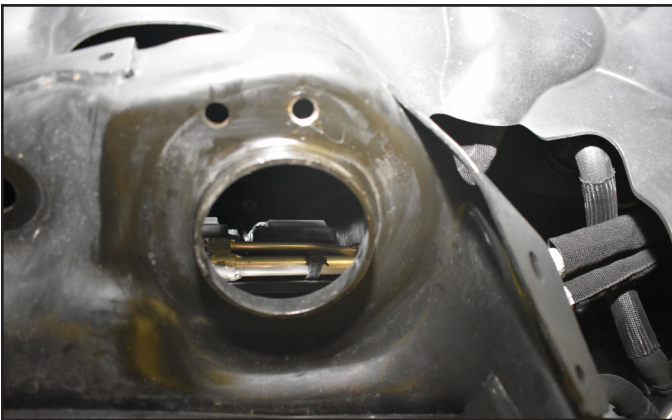
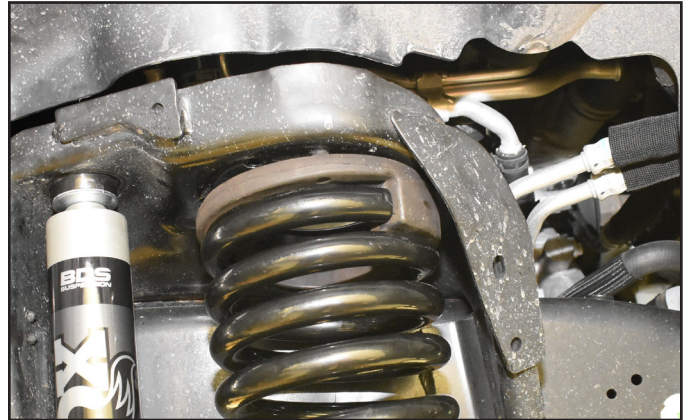

FIGURE 14B



26. Attach the lower shock with factory hardware. Tighten hardware to 65 ft-lbs.
27. Grease and install the bushings and sleeves into the shocks. Install the new shocks with cup washers, bushings, and 1/2" nut at the top mount. Tighten the nut until the bushings begin to swell.
28. Mark or measure the amount of exposed threads on the drag link sleeve. Loosen the drag link sleeve until you can rotate the tie rod end 180deg. Re-thread the drag link sleeve to the original Location. This is a starting point and will need to be adjusted after the installation is complete. (Fig 15, 16)

FIGURE 15

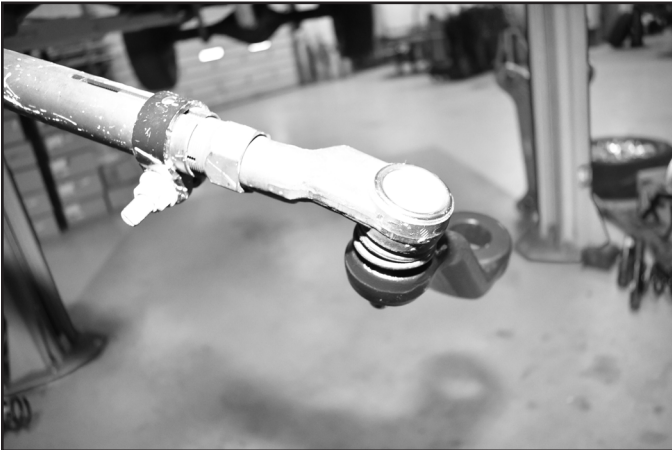

FIGURE 16



29. Install the new pitman arm, use the alignment mark made earlier. Thread locker factory nut and install with lock washer tighten nut to 332 ft-lbs. (Fig 17)

30. Attach the drag link to pitman arm with a factory nut. Tighten to 27 ft-lbs Plus 180deg. (Fig 17)

FIGURE 18

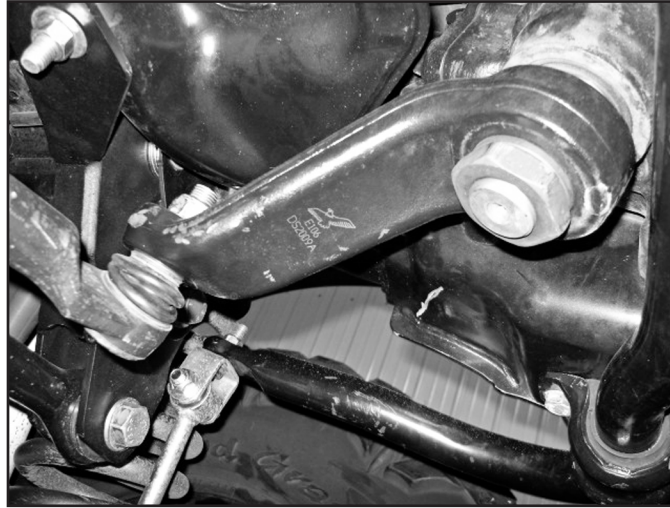

31. Disconnect the brake line bracket from the frame (Fig. 18 Driver side). Reattach the factory brake line bracket to the axle with factory hardware, torque to 10ft-lbs. slightly bend the factory axle bracket to create more slack in the brake line with a pliers or small adjustable wrench.
32. Mount the brake line relocation bracket to the factory brake line mount location at the frame with factory hardware, torque to 9ft-lbs. Mount the brake line to the relocation bracket using the provided hardware (Bolt pack 495), torque to 101 in-lbs. (Fig. 18 Driver Side shown, Fig. 19 Passenger side)

FIGURE 18



FIGURE 19

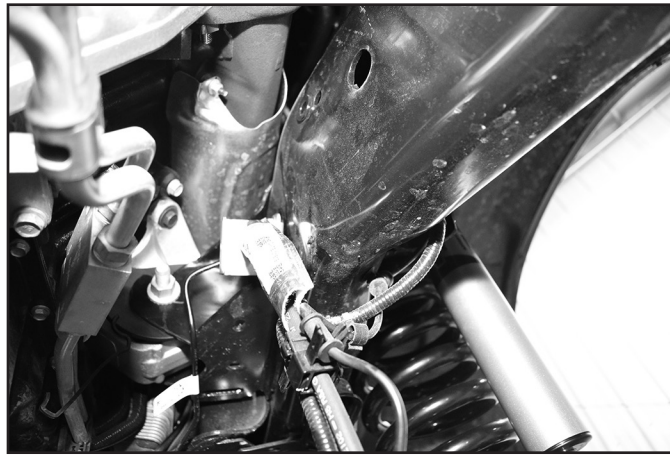

33. Install the sway bar drop brackets with factory hardware to the frame. The flat side of the bracket will face "out" and the brackets will offset the sway bar slightly forward. Attach the sway bar to the drop brackets with 3/8" hardware (Bolt Pack 422), tighten factory hardware to 43 ft-lbs and 3/8" hardware to 37 ft-lbs. (Fig. 20, 21)

FIGURE 20



FIGURE 21



34. Reconnect the sway bar links with the factory hardware, torque to 60ft-lbs

35. PLEASE SEE INDEX RING KIT INSTRUCTIONS AT THIS TIME.

36. PLEASE SEE REAR KIT INSTRUCTIONS AT THIS TIME.

37. Install wheels and tighten lug nuts to factory specifications. Lower the vehicle to the ground.
38. Tighten radius arm hardware at the frame to 258 ft-lbs.
39. If trackbar was disconnected from axle side for any reason, tighten trackbar axle hardware to 285 ft-lbs Turn the steering wheel to get the trackbar sleeve to align with the hole in the bracket. Tighten to 74 ft-lbs plus 160deg.
40. Recheck all hardware, check again at 500 miles, and again at regularly scheduled maintenance intervals.
41. Straighten the wheels, adjust the steering wheel to center. Torque the drag link clamp bolt to 55 ft-lbs. Do not drive the vehicle with the wheel off center or adverse traction control events may occur.

POST-INSTALLATION

42. Recheck all hardware, check again at 500 miles, and again at regularly scheduled maintenance intervals. Check brake lines and ABS wires for proper clearance through steering sweep, use zip ties on the ABS wires if necessary. An alignment must now be performed.



WE WANT TO SEE YOUR RIDE!

Grab photos of your BDS-equipped truck in action and send them in for a chance to be featured. Send it in to our Bad Ass Rides customer gallery at bds-suspension.com/bar and post them on the BDS Fan Page on Facebook at facebook.com/BDSSuspensions. Don't forget about your BDS swag! BDS offers t-shirts, hoodies, decals and more available on the BDS website or through your local BDS distributor.

TIME TO HAVE SOME FUN

Thank you for choosing BDS Suspension.

For questions, technical support and warranty issues relating to this BDS Suspension product, please contact your distributor/installer before contacting BDS Suspension directly.

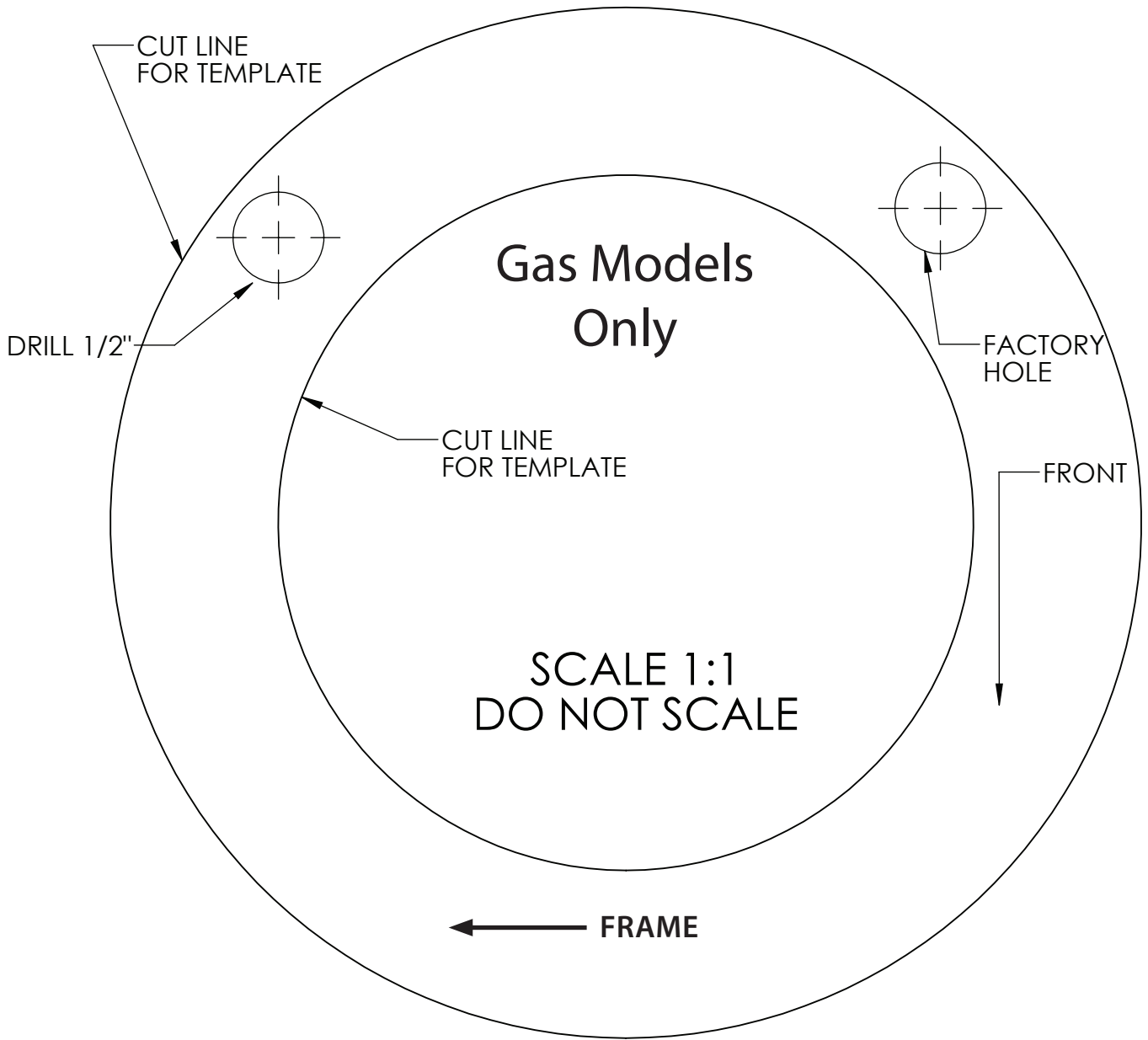

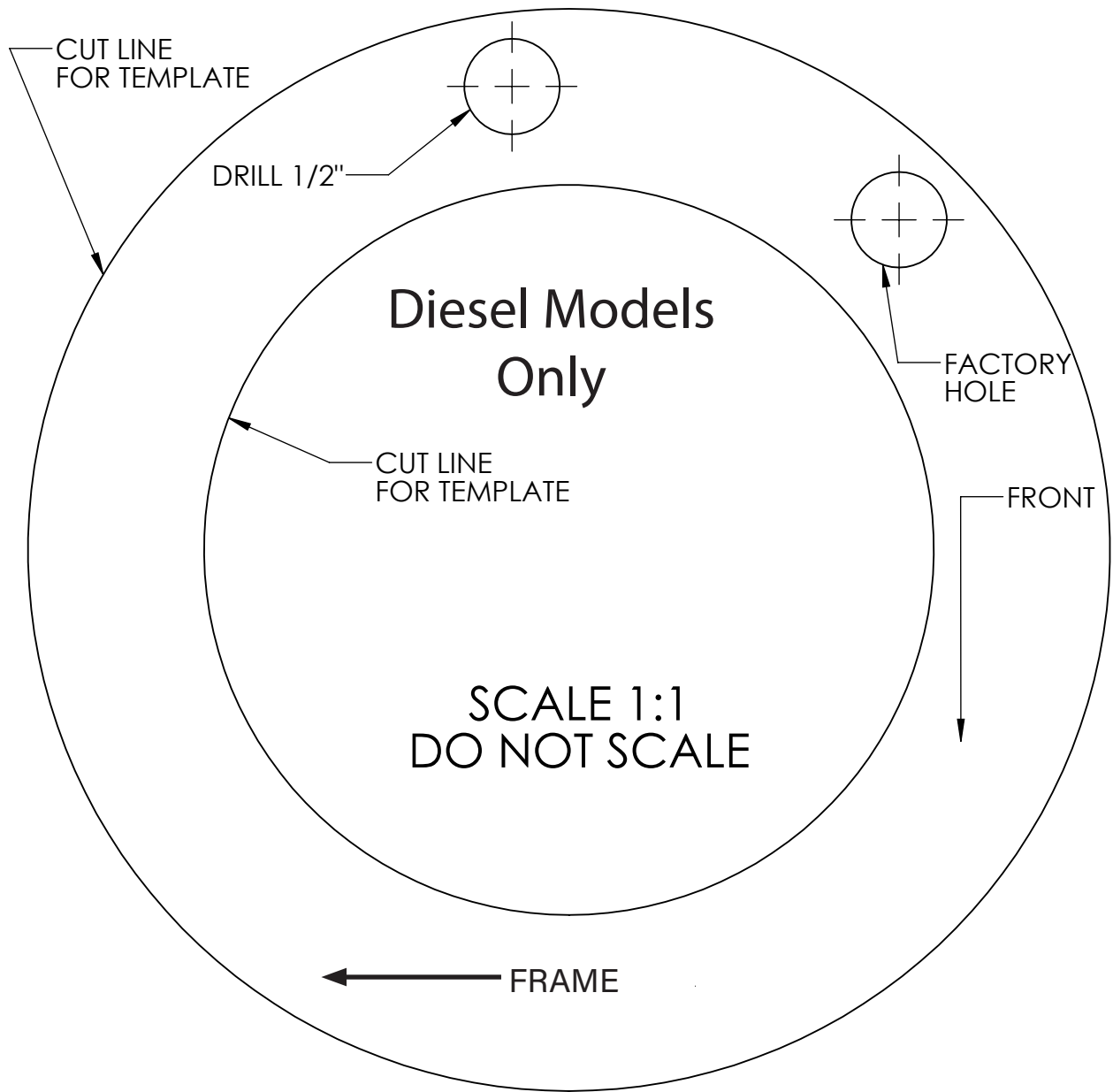

INSTALLATION GUIDE



Part#: 032491



HARDCORE LIMITED LIFETIME WARRANTY

4" Diesel / 5.5" Gas Coils

Dodge Ram 3500 4WD Pickup | 2013-2023

Dodge Ram 2500 4WD Pickup | 2014-2023

Rev. 071423

491 W. Garfield Ave., Coldwater, MI 49036 • Phone: 517-279-2135

Web/live chat: www.bds-suspension.com • E-mail: tech-bds@ridefox.com

Read And Understand All Instructions And Warnings Prior To Installation Of System And Operation Of Vehicle.



THANK YOU

Your truck is about to be fitted with the best suspension system on the market today. That means you will be driving the baddest looking truck in the neighborhood, and you'll have the warranty to ensure that it stays that way for years to come. Thank you for choosing BDS Suspension!

BEFORE YOU START

BDS Suspension Co. recommends this system be installed by a professional technician. In addition to these instructions, professional knowledge of disassembly/ reassembly procedures and post installation checks must be known.

FOR YOUR SAFETY

Certain BDS Suspension products are intended to improve off-road performance. Modifying your vehicle for off-road use may result in the vehicle handling differently than a factory equipped vehicle. Extreme care must be used to prevent loss of control or vehicle rollover. Failure to drive your modified vehicle safely may result in serious injury or death. BDS Suspension Co. does not recommend the combined use of suspension lifts, body lifts, or other lifting devices. You should never operate your modified vehicle under the influence of alcohol or drugs. Always drive your modified vehicle at reduced speeds to ensure your ability to control your vehicle under all driving conditions. Always wear your seat belt.

BEFORE INSTALLATION

- Special literature required: OE Service Manual for model/year of vehicle. Refer to manual for proper disassembly/reassembly procedures of OE and related components.
- Adhere to recommendations when replacement fasteners, retainers and keepers are called out in the OE manual.
- Larger rim and tire combinations may increase leverage on suspension, steering, and related components. When selecting combinations larger than OE, consider the additional stress you could be inducing on the OE and related components.
- Post suspension system vehicles may experience drive line vibrations. Angles may require tuning, slider on shaft may require replacement, shafts may need to be lengthened or trued, and U-joints may need to be replaced.
- Secure and properly block vehicle prior to installation of BDS Suspension components. Always wear safety glasses when using power tools.
- If installation is to be performed without a hoist, BDS Suspension Co. recommends rear alterations first.
- Due to payload options and initial ride height variances, the amount of lift is a base figure. Final ride height dimensions may vary in accordance to original vehicle attitude. Always measure the attitude prior to beginning installation.

BEFORE YOU DRIVE



Visit 560plus.com for more information.

Check all fasteners for proper torque. Check to ensure for adequate clearance between all rotating, mobile, fixed, and heated members. Verify clearance between exhaust and brake lines, fuel lines, fuel tank, floor boards and wiring harness. Check steering gear for clearance. Test and inspect brake system.

Perform steering sweep to ensure front brake hoses have adequate slack and do not contact any rotating, mobile or heated members. Inspect rear brake hoses at full extension for adequate slack. Failure to perform hose check/ replacement may result in component failure. Longer replacement hoses, if needed can be purchased from a local parts supplier.

Perform head light check and adjustment.

Re-torque all fasteners after 500 miles. Always inspect fasteners and components during routine servicing.

INSTALLATION INSTRUCTIONS

4" DIESEL/5.5" GAS

Lower the axle and install the new coils with factory isolator. The end of the spring with the windings closer together will go at the top, do not install upside down. The passenger's side upper mount will need to be reindexed. There is a template at the end of the instruction sheet. Cut this out and place over the passenger's side upper mount, mark the center of the hole, and drill to 1/2". The hole should now be directly to the 'Outside' of the vehicle. Ensure that coils are seated properly, have someone help if necessary. (Fig 1, 2, 3, 4)

FIGURE 1



FIGURE 2

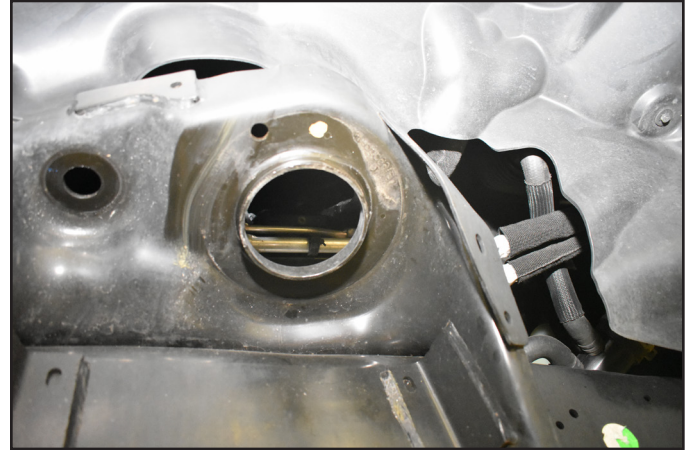
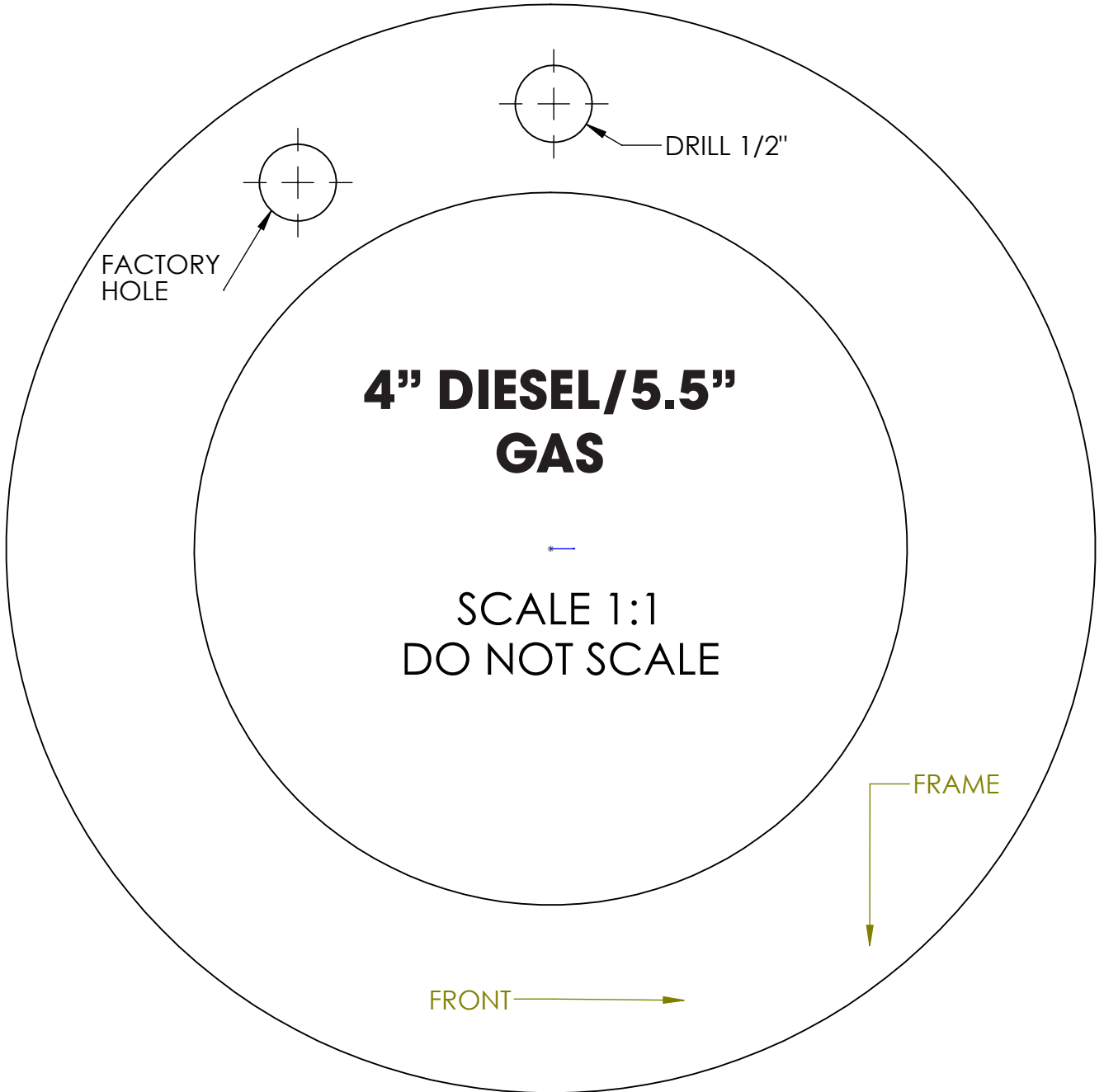

FIGURE 3



FIGURE 4





INSTALLATION GUIDE



Part#: 032403



HARDCORE LIMITED LIFETIME WARRANTY

4" Diesel / 5.5" Gas Air Ride Coils

Dodge Ram 3500 4WD Pickup | 2013
Dodge Ram 2500 4WD Pickup | 2023

Rev. 071423

491 W. Garfield Ave., Coldwater, MI 49036 • Phone: 517-279-2135

Web/live chat: www.bds-suspension.com • E-mail: tech-bds@ridefox.com

Read And Understand All Instructions And Warnings Prior To Installation Of System And Operation Of Vehicle.



THANK YOU

Your truck is about to be fitted with the best suspension system on the market today. That means you will be driving the baddest looking truck in the neighborhood, and you'll have the warranty to ensure that it stays that way for years to come. Thank you for choosing BDS Suspension!

BEFORE YOU START

BDS Suspension Co. recommends this system be installed by a professional technician. In addition to these instructions, professional knowledge of disassembly/ reassembly procedures and post installation checks must be known.

FOR YOUR SAFETY

Certain BDS Suspension products are intended to improve off-road performance. Modifying your vehicle for off-road use may result in the vehicle handling differently than a factory equipped vehicle. Extreme care must be used to prevent loss of control or vehicle rollover. Failure to drive your modified vehicle safely may result in serious injury or death. BDS Suspension Co. does not recommend the combined use of suspension lifts, body lifts, or other lifting devices. You should never operate your modified vehicle under the influence of alcohol or drugs. Always drive your modified vehicle at reduced speeds to ensure your ability to control your vehicle under all driving conditions. Always wear your seat belt.

BEFORE INSTALLATION

- Special literature required: OE Service Manual for model/year of vehicle. Refer to manual for proper disassembly/reassembly procedures of OE and related components.
- Adhere to recommendations when replacement fasteners, retainers and keepers are called out in the OE manual.
- Larger rim and tire combinations may increase leverage on suspension, steering, and related components. When selecting combinations larger than OE, consider the additional stress you could be inducing on the OE and related components.
- Post suspension system vehicles may experience drive line vibrations. Angles may require tuning, slider on shaft may require replacement, shafts may need to be lengthened or trued, and U-joints may need to be replaced.
- Secure and properly block vehicle prior to installation of BDS Suspension components. Always wear safety glasses when using power tools.
- If installation is to be performed without a hoist, BDS Suspension Co. recommends rear alterations first.
- Due to payload options and initial ride height variances, the amount of lift is a base figure. Final ride height dimensions may vary in accordance to original vehicle attitude. Always measure the attitude prior to beginning installation.



Visit 560plus.com for more information.

TIRES AND WHEELS

FITMENT GUIDE

4" Lift:

37x12.50 w/ 5.625" Backspacing on 9" wide wheel

35x12.50 w/ 4.5" Backspacing on 9" wide wheel



BEFORE YOU DRIVE

Check all fasteners for proper torque. Check to ensure for adequate clearance between all rotating, mobile, fixed, and heated members. Verify clearance between exhaust and brake lines, fuel lines, fuel tank, floor boards and wiring harness. Check steering gear for clearance. Test and inspect brake system.

Perform steering sweep to ensure front brake hoses have adequate slack and do not contact any rotating, mobile or heated members. Inspect rear brake hoses at full extension for adequate slack. Failure to perform hose check/ replacement may result in component failure. Longer replacement hoses, if needed can be purchased from a local parts supplier.

Perform head light check and adjustment.

Re-torque all fasteners after 500 miles. Always inspect fasteners and components during routine servicing.

INSTALLATION INSTRUCTIONS

4" Diesel / 5.5" Gas Air Ride

Lower the axle and install the new coils with factory isolator. The end of the spring with the windings closer together will go at the top, do not install upside down. The passenger's side upper mount will need to be reindexed. There is a template at the end of the instruction sheet. Cut this out and place over the passenger's side upper mount, mark the center of the hole, and drill to 1/2". The hole should now be directly to the 'Rear' of the vehicle. Install isolator with the new coil spring. Ensure that coils are seated properly, have someone help if necessary. (Fig 1, 2, 3, 4)

FIGURE 1



FIGURE 2

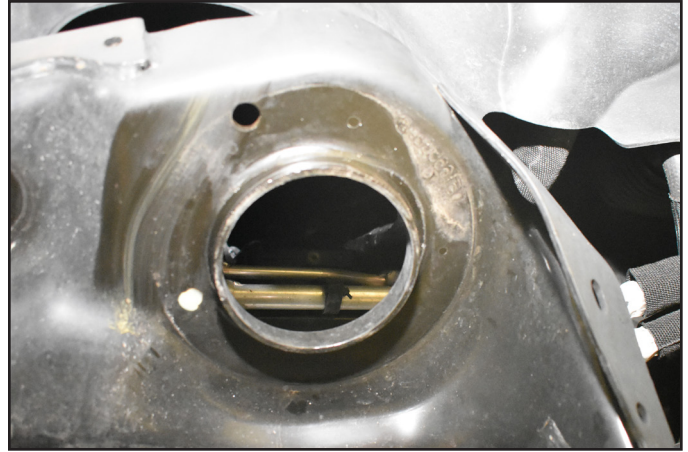
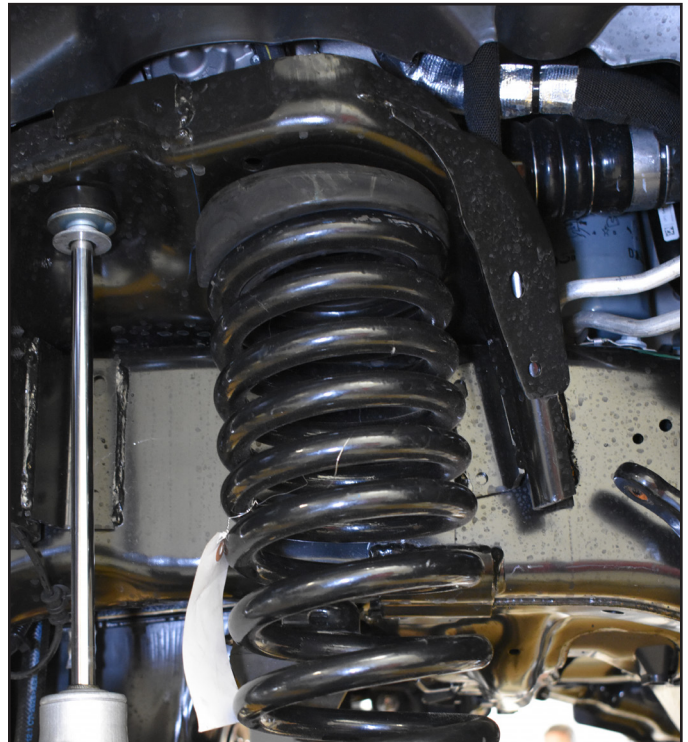
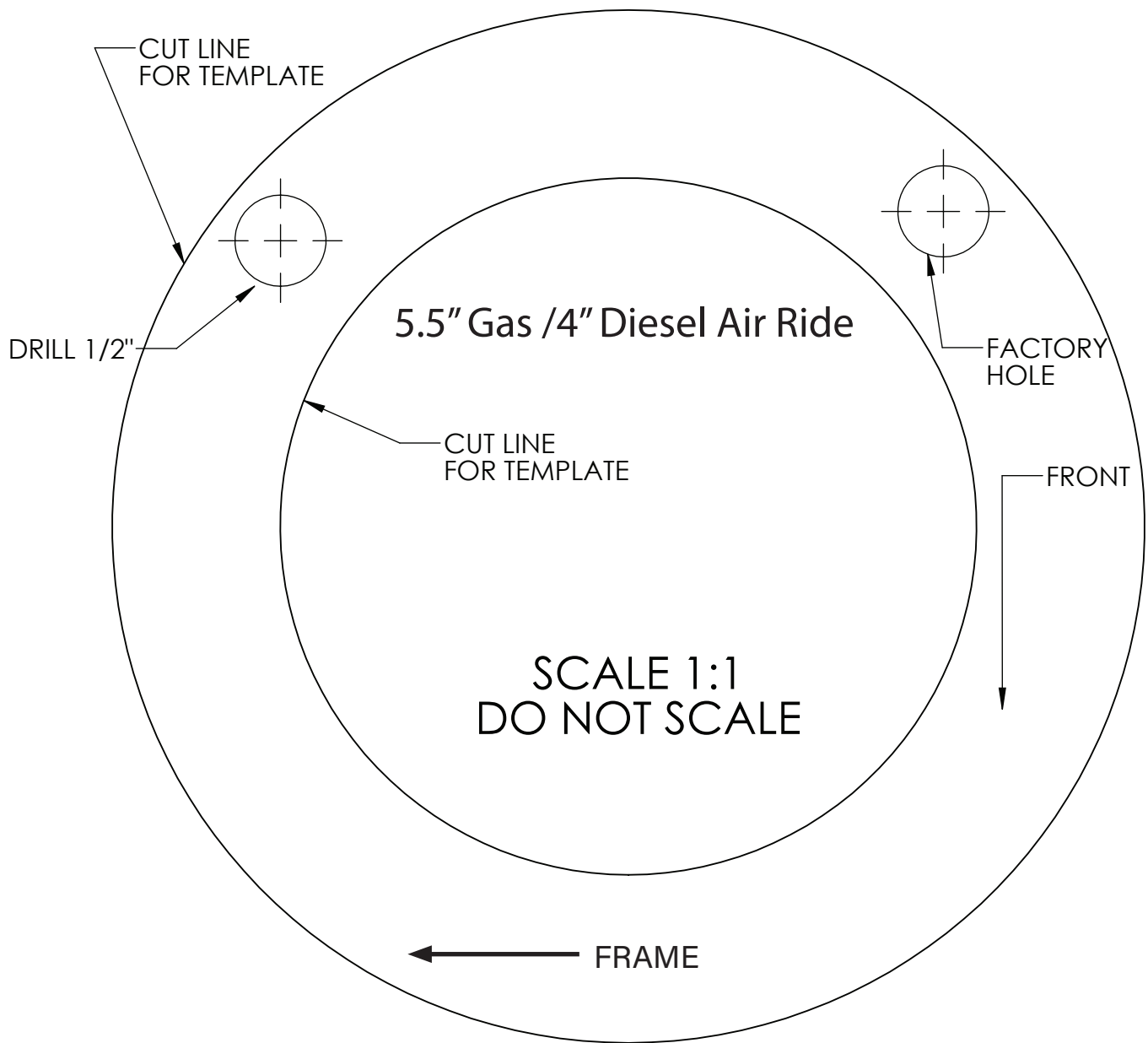

FIGURE 3



FIGURE 4





INSTALLATION GUIDE



Part#: 032602

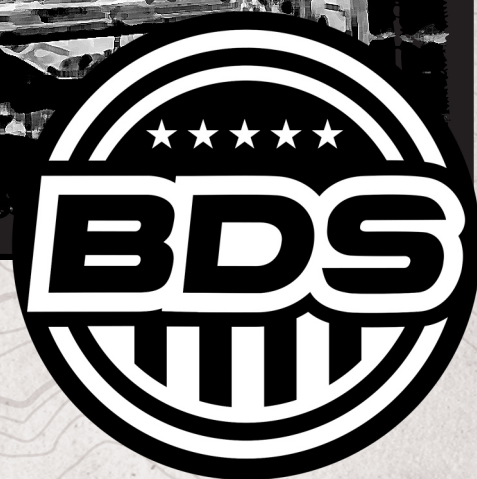

HARDCORE LIMITED LIFETIME WARRANTY

6" Diesel Coils

Dodge Ram 3500 4WD Pickup | 2013-2023

Dodge Ram 2500 4WD Pickup | 2014-2023

Rev. 071423

491 W. Garfield Ave., Coldwater, MI 49036 • Phone: 517-279-2135

Web/live chat: www.bds-suspension.com • E-mail: tech-bds@ridefox.com

Read And Understand All Instructions And Warnings Prior To Installation Of System And Operation Of Vehicle.



THANK YOU

Your truck is about to be fitted with the best suspension system on the market today. That means you will be driving the baddest looking truck in the neighborhood, and you'll have the warranty to ensure that it stays that way for years to come. Thank you for choosing BDS Suspension!

BEFORE YOU START

BDS Suspension Co. recommends this system be installed by a professional technician. In addition to these instructions, professional knowledge of disassembly/ reassembly procedures and post installation checks must be known.

FOR YOUR SAFETY

Certain BDS Suspension products are intended to improve off-road performance. Modifying your vehicle for off-road use may result in the vehicle handling differently than a factory equipped vehicle. Extreme care must be used to prevent loss of control or vehicle rollover. Failure to drive your modified vehicle safely may result in serious injury or death. BDS Suspension Co. does not recommend the combined use of suspension lifts, body lifts, or other lifting devices. You should never operate your modified vehicle under the influence of alcohol or drugs. Always drive your modified vehicle at reduced speeds to ensure your ability to control your vehicle under all driving conditions. Always wear your seat belt.

BEFORE INSTALLATION

- Special literature required: OE Service Manual for model/year of vehicle. Refer to manual for proper disassembly/reassembly procedures of OE and related components.
- Adhere to recommendations when replacement fasteners, retainers and keepers are called out in the OE manual.
- Larger rim and tire combinations may increase leverage on suspension, steering, and related components. When selecting combinations larger than OE, consider the additional stress you could be inducing on the OE and related components.
- Post suspension system vehicles may experience drive line vibrations. Angles may require tuning, slider on shaft may require replacement, shafts may need to be lengthened or trued, and U-joints may need to be replaced.
- Secure and properly block vehicle prior to installation of BDS Suspension components. Always wear safety glasses when using power tools.
- If installation is to be performed without a hoist, BDS Suspension Co. recommends rear alterations first.
- Due to payload options and initial ride height variances, the amount of lift is a base figure. Final ride height dimensions may vary in accordance to original vehicle attitude. Always measure the attitude prior to beginning installation.



Visit 560plus.com for more information.

BEFORE YOU DRIVE

Check all fasteners for proper torque. Check to ensure for adequate clearance between all rotating, mobile, fixed, and heated members. Verify clearance between exhaust and brake lines, fuel lines, fuel tank, floor boards and wiring harness. Check steering gear for clearance. Test and inspect brake system.

Perform steering sweep to ensure front brake hoses have adequate slack and do not contact any rotating, mobile or heated members. Inspect rear brake hoses at full extension for adequate slack. Failure to perform hose check/ replacement may result in component failure. Longer replacement hoses, if needed can be purchased from a local parts supplier.

Perform head light check and adjustment.

Re-torque all fasteners after 500 miles. Always inspect fasteners and components during routine servicing.

INSTALLATION INSTRUCTIONS

6" Diesel

Lower the axle and install the new coils with factory isolator. The end of the spring with the windings closer together will go at the top, do not install upside down. The passenger's side upper mount will need to be reindexed. There is a template at the end of the instruction sheet. Cut this out and place over the passenger's side upper mount, mark the center of the hole, and drill to 1/2". The hole should now be directly to the 'Rear' of the vehicle. Install isolator with the new coil spring. Ensure that coils are seated properly, have someone help if necessary. (Fig 1, 2, 3, 4)

FIGURE 1



FIGURE 2

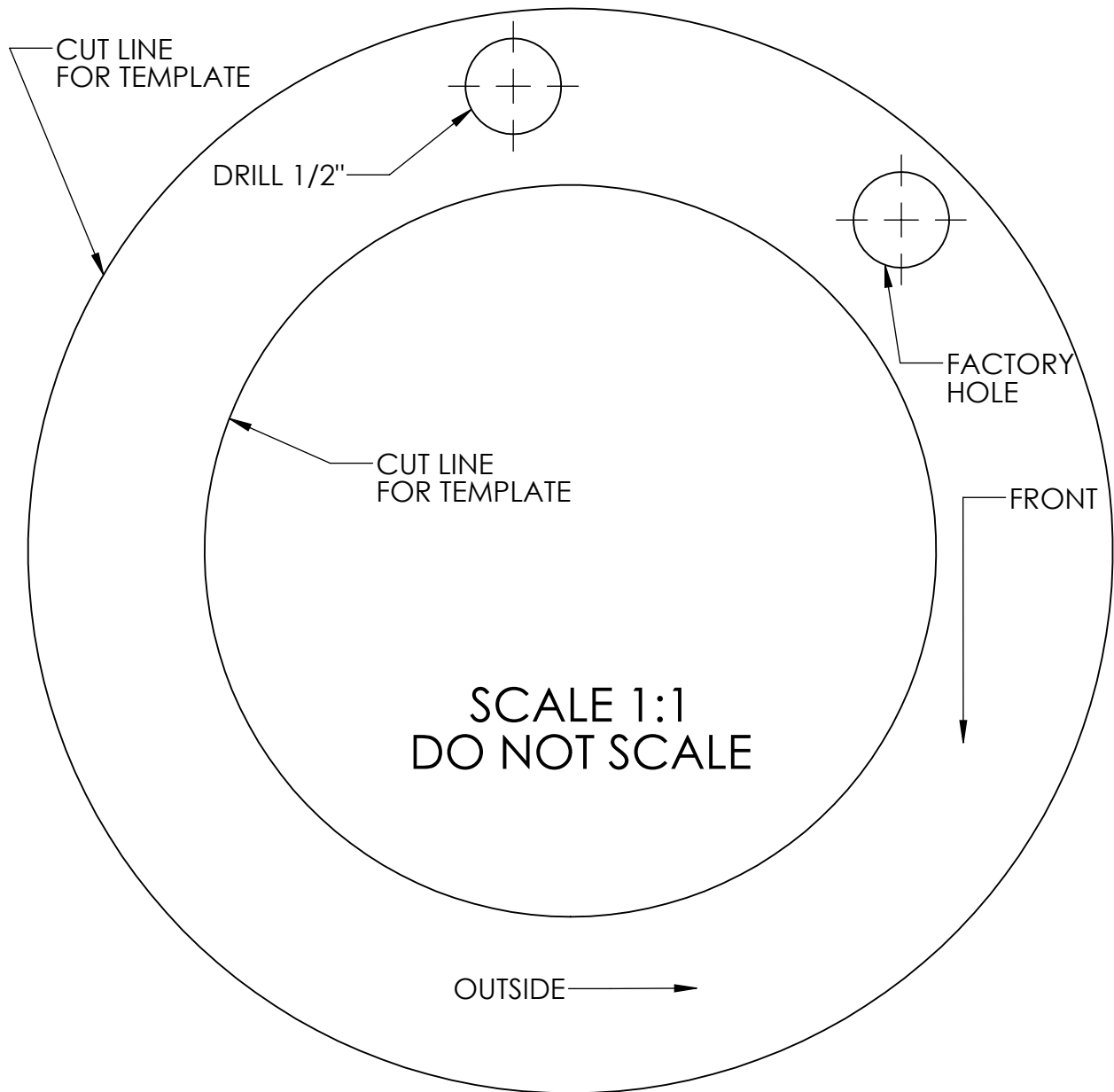

FIGURE 3



FIGURE 4





TIME TO HAVE SOME FUN

Thank you for choosing BDS Suspension.

For questions, technical support and warranty issues relating to this BDS Suspension product, please contact your distributor/installer before contacting BDS Suspension directly.