

# INSTALLATION GUIDE

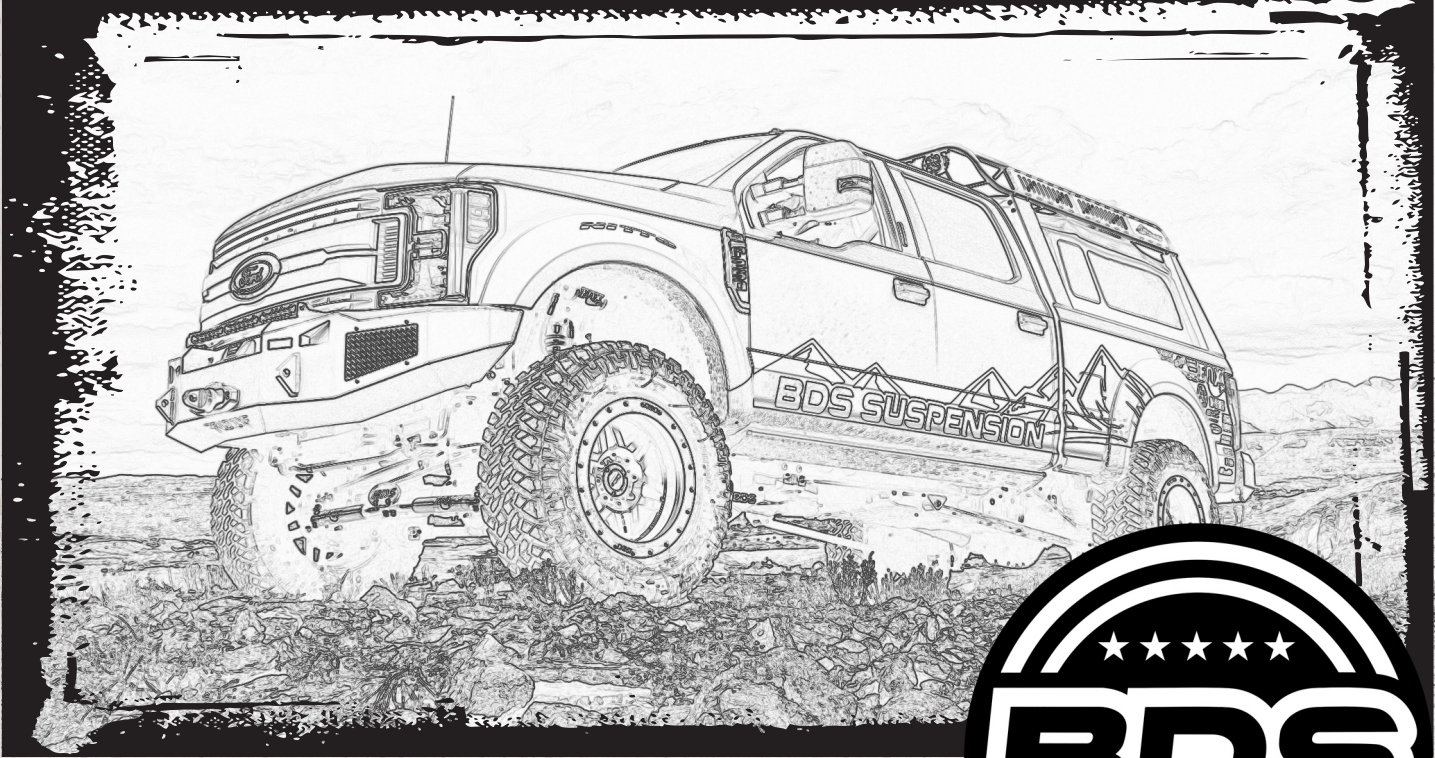

Part#: 123613



**HARDCORE LIMITED LIFETIME WARRANTY**

## Coilover Installation Instructions

**Ford F-250 & F-350 Superduty 4WD | 2017-2026**

Rev. 010726

491 W. Garfield Ave., Coldwater, MI 49036 • Phone: 517-279-2135

E-mail: [tech-bds@ridefox.com](mailto:tech-bds@ridefox.com)



# Read And Understand All Instructions And Warnings Prior To Installation Of System And Operation Of Vehicle.

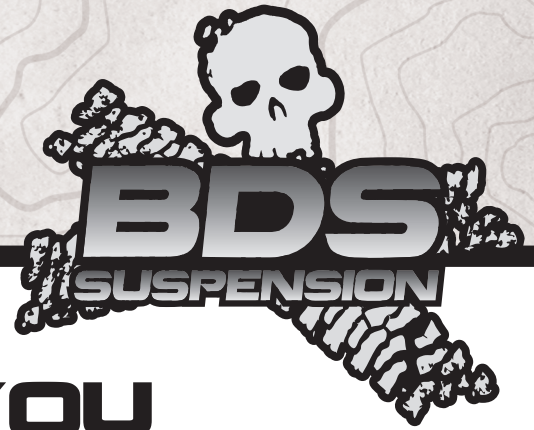

## THANK YOU

Your truck is about to be fitted with the best suspension system on the market today. That means you will be driving the baddest looking truck in the neighborhood, and you'll have the warranty to ensure that it stays that way for years to come.

Thank you for choosing BDS Suspension!

### BEFORE YOU START

BDS Suspension Co. recommends this system be installed by a professional technician. In addition to these instructions, professional knowledge of disassembly/ reassembly procedures and post installation checks must be known.

Recalibration of your vehicles Advanced Driver Assistance System (ADAS) cameras, radars, light detection and ranging (LiDAR), and other sensors may be necessary after any vehicle modification. This can be performed at your local dealership or an ADAS service center. This will ensure proper functionality of the vehicle features such as lane keeping, lane departure, parking assistance, blind-spot detection, adaptive cruise control systems, and other functions as they did prior to installation. Please connect with your local dealership or ADAS service center. Similar to a wheel alignment, all charges and expenses that may occur from dealership calibrations and adjustments are the sole responsibility of the vehicle owner.

### FOR YOUR SAFETY

Certain BDS Suspension products are intended to improve off-road performance. Modifying your vehicle for off-road use may result in the vehicle handling differently than a factory equipped vehicle. Extreme care must be used to prevent loss of control or vehicle rollover. Failure to drive your modified vehicle safely may result in serious injury or death. BDS Suspension Co. does not recommend the combined use of suspension lifts, body lifts, or other lifting devices. You should never operate your modified vehicle under the influence of alcohol or drugs. Always drive your modified vehicle at reduced speeds to ensure your ability to control your vehicle under all driving conditions. Always wear your seat belt.

### BEFORE INSTALLATION

- Special literature required: OE Service Manual for model/year of vehicle. Refer to manual for proper disassembly/reassembly procedures of OE and related components.
- Adhere to recommendations when replacement fasteners, retainers and keepers are called out in the OE manual.
- Larger rim and tire combinations may increase leverage on suspension, steering, and related components. When selecting combinations larger than OE, consider the additional stress you could be inducing on the OE and related components.
- Post suspension system vehicles may experience drive line vibrations. Angles may require tuning, slider on shaft may require replacement, shafts may need to be lengthened or trued, and U-joints may need to be replaced.



Visit [560plus.com](http://560plus.com) for more information.

### TIRES AND WHEELS

4-1/2" backspace wheels with 12.50 width tire are recommended for tire to reservoir hose clearance. Stock wheels are not recommended.



- Secure and properly block vehicle prior to installation of BDS Suspension components. Always wear safety glasses when using power tools.
- If installation is to be performed without a hoist, BDS Suspension Co. recommends rear alterations first.
- Due to payload options and initial ride height variances, the amount of lift is a base figure. Final ride height dimensions may vary in accordance to original vehicle attitude. Always measure the attitude prior to beginning installation.

### BEFORE YOU DRIVE

Check all fasteners for proper torque. Check to ensure for adequate clearance between all rotating, mobile, fixed, and heated members. Verify clearance between exhaust and brake lines, fuel lines, fuel tank, floor boards and wiring harness. Check steering gear for clearance. Test and inspect brake system.

Perform steering sweep to ensure front brake hoses have adequate slack and do not contact any rotating, mobile or heated members. Inspect rear brake hoses at full extension for adequate slack. Failure to perform hose check/ replacement may result in component failure. Longer replacement hoses, if needed can be purchased from a local parts supplier.

Perform head light check and adjustment.

Re-torque all fasteners after 500 miles. Always inspect fasteners and components during routine servicing.

# CONTENTS OF YOUR KIT

Box Kit		
Part #	Qty	Description
02716	2	Lower Coilover Mount
03427	2	Upper Coilover Mounting Bracket
	6	Zip Tie
2296	2	2" Bump Stop (2.5" Kit)
953	1	Bolt Pack
	2	14mm-2.00 x 30mm Bolt
	2	14mm Flat Washer
	2	7/16" Clamp w/ 0.281 Hole
	4	1/4"-20 x 3/4" Bolt
	4	1/4"-20 Nylock Nut
	8	1/4" SAE Washer
	4	#10-24 x 3/4" Machine Screw
	4	#10-24 Serrated Edge Flanged Nut
	4	#10 SAE Washer

Box Kit		
Part #	Qty	Description
988	1	Bolt Pack
	4	1/2"-13 x 2-3/4" Bolt
	8	1/2" SAE Washer
	4	1/2"-13 Prevailing Torque Nut
	6	7/16"-14 x 1-1/4" Bolt
	12	7/16" SAE Washer
	6	7/16"-14 Prevailing Torque Nut
	2	8mm-1.25 x 70mm Bolt
	4	5/16" USS Washer

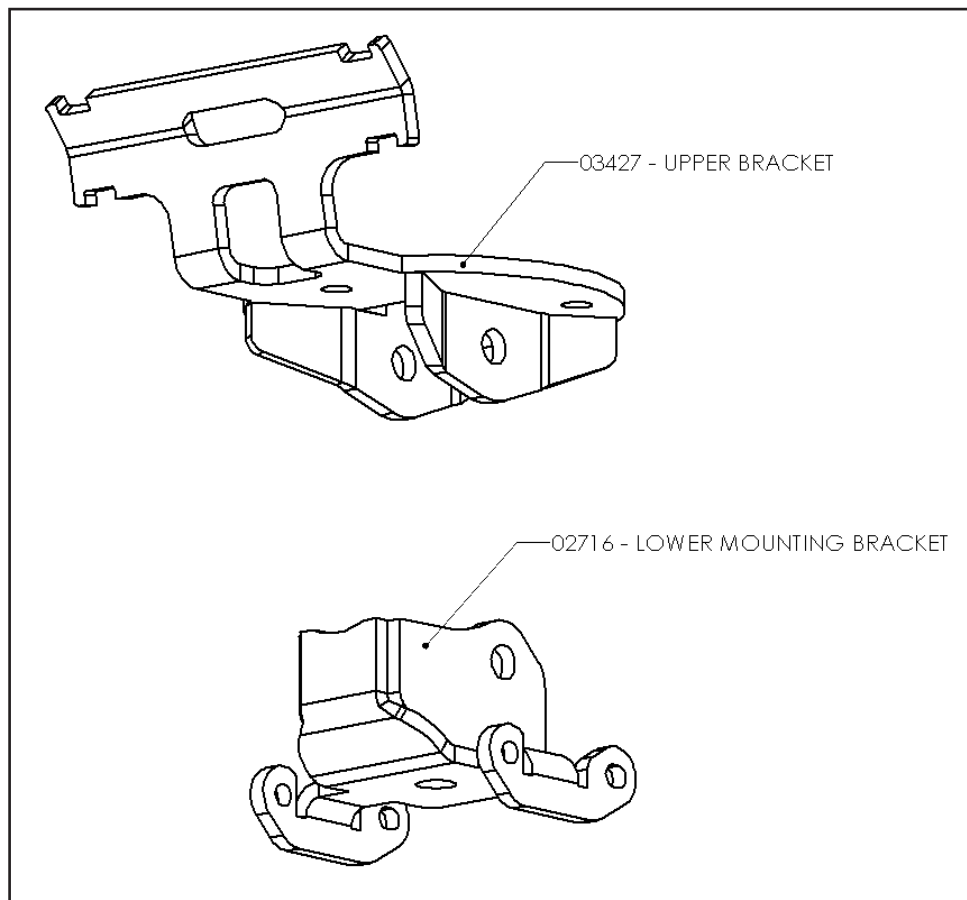

## TECH TIPS

### TROUBLESHOOTING INFORMATION FOR YOUR VEHICLE

1. This is only the installation instructions for installation of the coilover shocks and mounting brackets, does not include the installation instructions for any other applicable kit components which must be purchased separately.
2. Stock wheels and tires are not recommended due to factory offset

## INSTALLATION INSTRUCTIONS

### INSTALLATION INSTRUCTIONS

1. Park vehicle on clean, flat, and level surface.
2. Raise front of vehicle and support frame rails with jack stands.
3. Remove the front wheels.
4. Support the front axle with a hydraulic jack.
5. Disconnect the sway bar links from the sway bar, this will allow the axle to droop out enough. (Fig 1)

### SPECIAL TOOLS

Sawzall with long blade  
Drill

**FIGURE 1**



6. Remove the front shocks, retain lower shock hardware.



7. Disconnect the brake line bracket from the factory lower coil seat (Fig 2). Disconnect the ABS lines from the backside of the lower coil seat.

**FIGURE 2**



8. Lower the axle and remove the factory coil springs and upper coil spring isolator. Take care not to over extend any brake, ABS, or vacuum lines. (Fig 3)

**FIGURE 3**

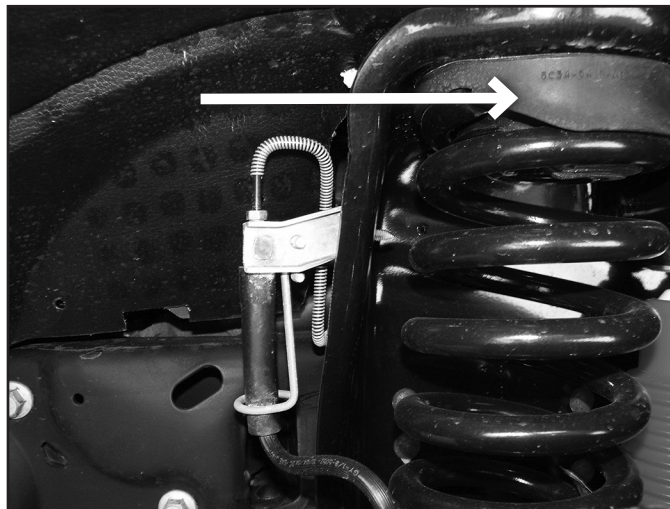

9. Remove the lower coil spring seat from the top of the axle, it will not be reinstated.

## UPPER COIL BUCKET MODIFICATION

10. Trim the upper coil spring centering tube from the factory mount with a sawzall. Ensure the cut is flush with the mounting surface. (Fig 4a, 4b)

**FIGURE 4A**



**FIGURE 4B**

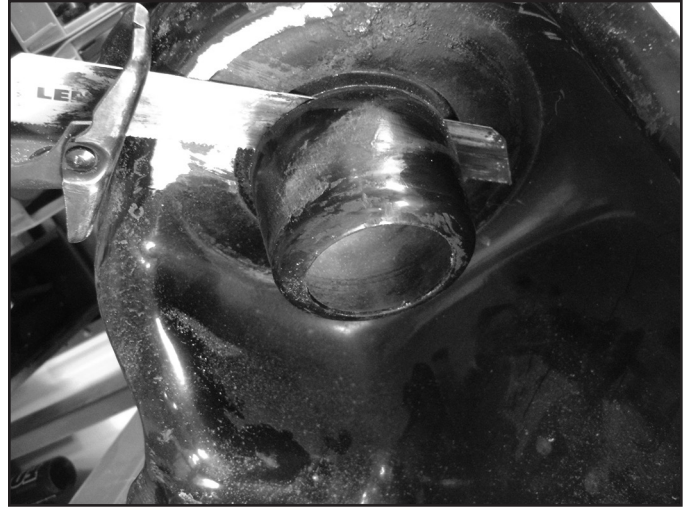

11. Disconnect the module from the driver's side coil bucket (attached in 3 places), may not be present on all model years / engine configurations. Move the module up so that it is not damaged when the holes are drilled.
12. The cable tie mount on the passenger side will need to be bent up in order to clear the upper coilover mount. First remove the cable tie from the mount and then bend the mount up so that it is at least 3/8" above the bottom side of the coil bucket. After the cable tie mount is bent up, reconnect the cable tie to the mount.

**FIGURE 5A**



**FIGURE 5B**

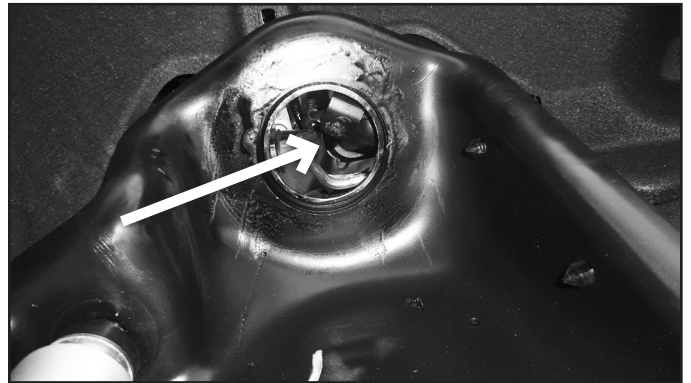

13. Place the upper coilover mounting bracket up to the upper mount. Rotate the bracket so that the reservoir bracket is parallel with the frame. (Fig 6)



**FIGURE 6**

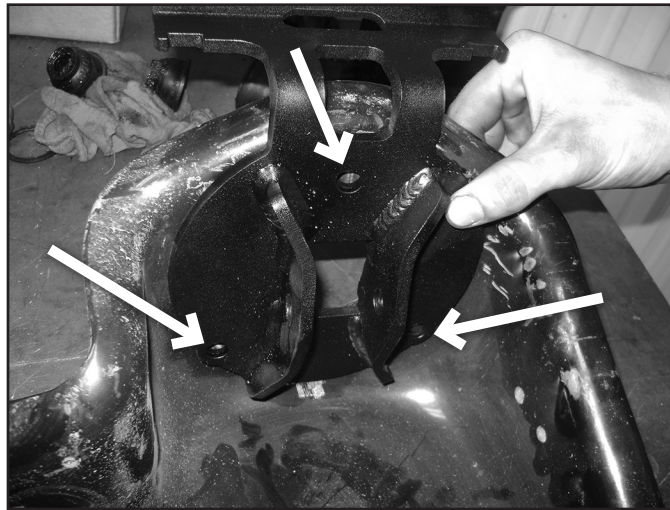

14. Mark the center of the holes, remove bracket, and drill out to 15/32" to 1/2". Make sure the drill does not damage the module on the driver's side (not present on all model year trucks).!

*NOTE: On the passenger side, ensure that the wire harness behind the wheel well liner will not be pinched by the reservoir bracket. The liner may need to be removed to allow the wire harness to be reformed.*

15. Install the bracket with 7/16" hardware, run the bolts from top-down. Do NOT tighten at this time, the mount needs to be loose to install the upper coilover hardware. Thread the nuts on by hand a couple of turns to hold the bracket in place. (Fig 7)

**FIGURE 7**

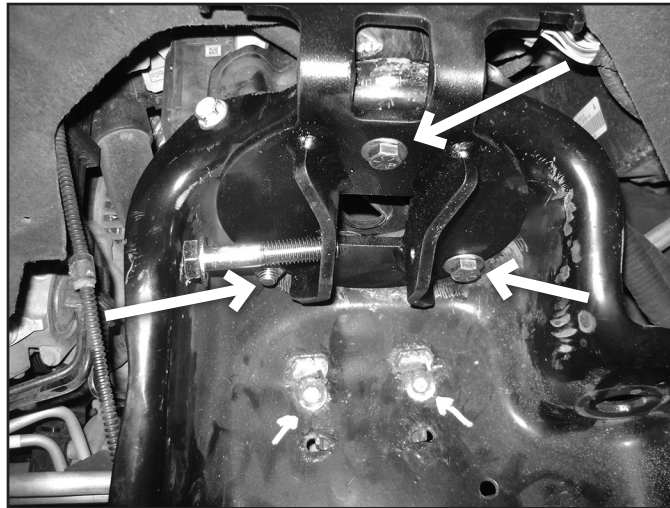

16. Install the lower bracket with new 14mm bolt (#953). Tighten to 75 ft-lbs.
17. Install the coilover into the upper mounting bracket with 1/2" x 2-3/4" bolt (#988). Coilovers are marked side specific. Bolt is a tight squeeze to fit into the bracket and between the stock bracket. It may be necessary to loosen the upper mount more to allow the bolt to fit into the mounting bracket.
18. Attach the coilover to the lower mounting bracket with 1/2" x 2-3/4" hardware (#988).
19. Tighten all coilover and mounting bracket hardware at this time. 7/16" hardware: 45 ft-lbs, 1/2" 65 ft-lbs.
20. Attach the reservoir to the mounting bracket with the included hose clamps. Rotate the reservoir so that the hose is pointed slightly 'inward' for extra tire clearance. (Fig 8)

**FIGURE 8**



**BUMP STOP INSTALLATION**

21. Remove the factory bump stop, remove the factory hardware that attaches the cup to the frame.
22. Make sure the bump stop extension is installed in conjunction with the lift system. Damage to the coilover or other parts may result from not installing the bump stop extension.
23. 2.5" Kit Only: Install the provided bump stop spacer in this kit (2" tall for 2.5" kits) and factory bump stop cup with the 8mm x 70mm bolt and 5/16" USS Washer from Bolt Pack 988. Tighten to 25 ft-lbs. Reinstall the factory bump stop into the bump stop cup. (Fig 9)

**FIGURE 9 (2.5" KIT ONLY)**

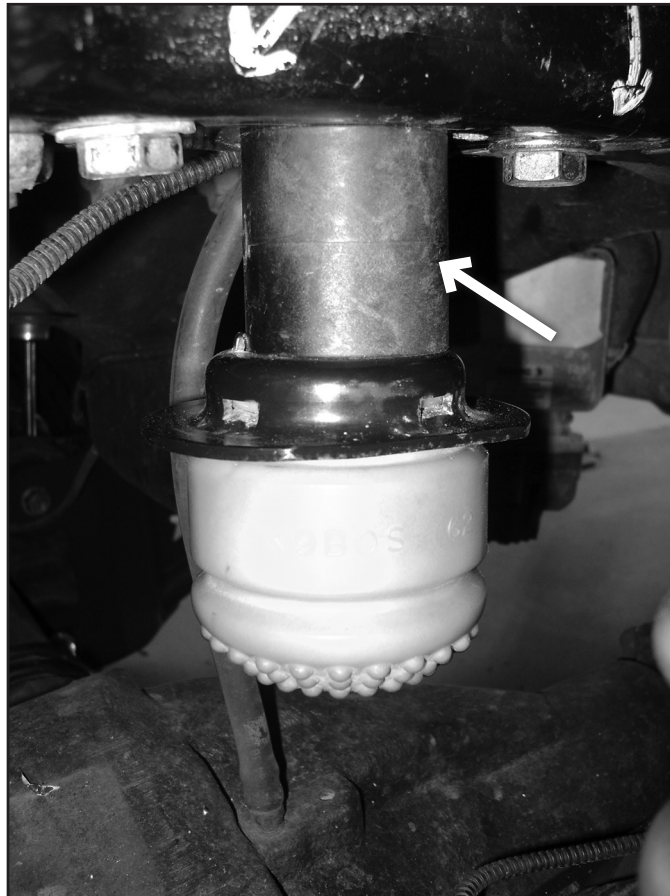

24. Attach the front axle lines to the new lower bracket with included 1/4" hardware. Aftermarket brake lines will use the included wire clamp (shown in figure). Additional zip ties are included to retain any ABS / vacuum lines if necessary. (Fig 10) The ABS wire will attach with #10 hardware from bolt pack #953.



**FIGURE 10**



25. Install optional auxiliary shock in factory position with factory hardware if desired.
26. Continue with lift kit installation at this time. If the coilover system is being installed as an upgrade to a current lift system, follow the instructions below.
27. Reattach sway bar links to sway bar. Reinstall wheels.
28. Cycle steering at full droop and check for adequate clearances
29. Lower vehicle to the ground and torque lug nuts to factory specification. Cycle steering to check for adequate clearances.
30. Recheck all hardware for proper torque, recheck again after 500 miles.



## **WE WANT TO SEE YOUR RIDE!**

Grab photos of your BDS-equipped truck in action and send them in for a chance to be featured. Send it in to our Bad Ass Rides customer gallery at [bds-suspension.com/bar](http://bds-suspension.com/bar) and post them on the BDS Fan Page on Facebook at [facebook.com/BDSSuspensions](https://facebook.com/BDSSuspensions). Don't forget about your BDS swag! BDS offers t-shirts, hoodies, decals and more available on the BDS website or through your local BDS distributor.

---

## **TIME TO HAVE SOME FUN**

**Thank you for choosing BDS Suspension.**

For questions, technical support and warranty issues relating to this BDS Suspension product, please contact your distributor/installer before contacting BDS Suspension directly.