

INSTALLATION GUIDE

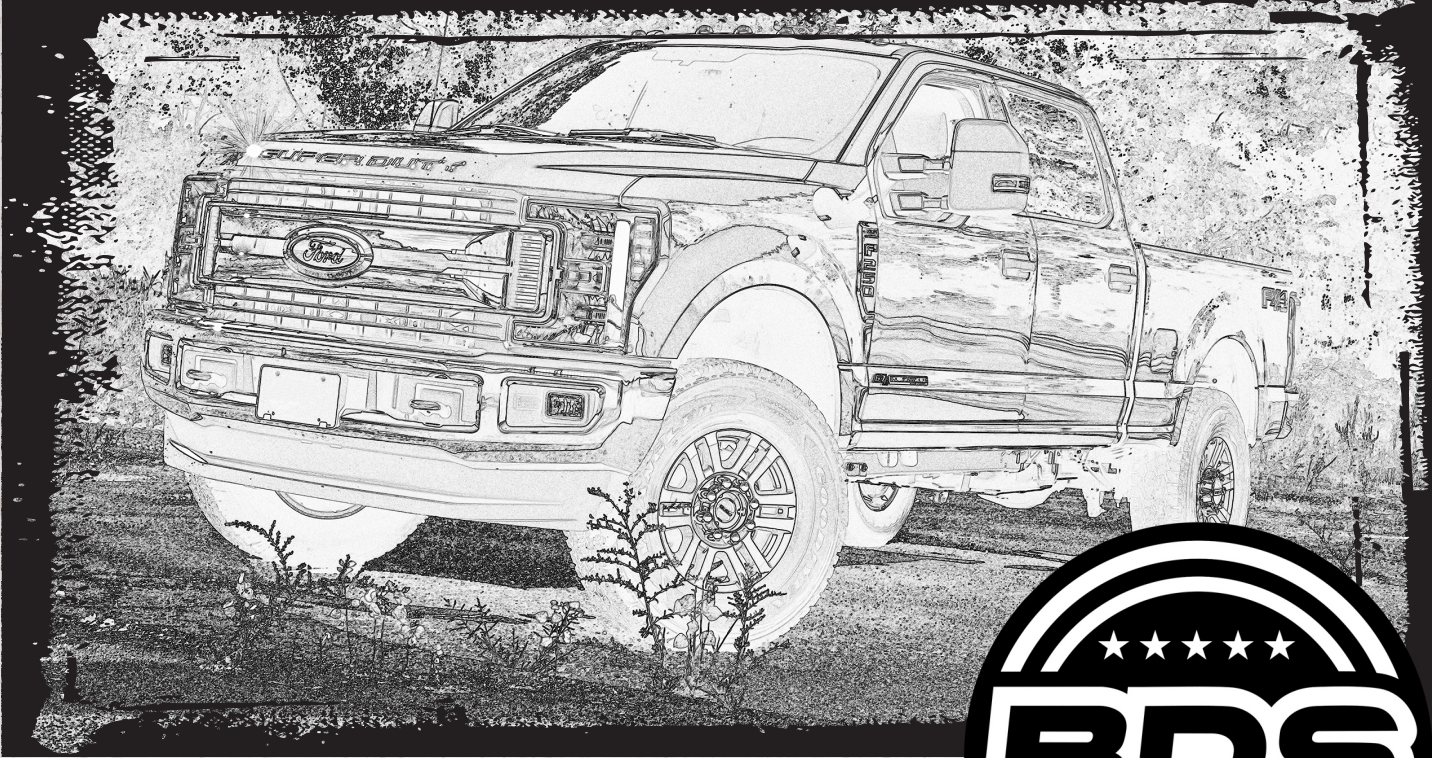

Part#: 013205



HARDCORE LIMITED LIFETIME WARRANTY

Front Performance Spring Kit

1" Ford F250/350 4WD | 2017-2019

2" Ford F250/350 4WD | 2020-2026

Rev. 020626

491 W. Garfield Ave., Coldwater, MI 49036 • Phone: 517-279-2135

E-mail: tech-bds@ridefox.com

Read And Understand All Instructions And Warnings Prior To Installation Of System And Operation Of Vehicle.



THANK YOU

Your truck is about to be fitted with the best suspension system on the market today. That means you will be driving the baddest looking truck in the neighborhood, and you'll have the warranty to ensure that it stays that way for years to come.

Thank you for choosing BDS Suspension!

BEFORE YOU START

BDS Suspension Co. recommends this system be installed by a professional technician. In addition to these instructions, professional knowledge of disassembly/ reassembly procedures and post installation checks must be known.

FOR YOUR SAFETY

Certain BDS Suspension products are intended to improve off-road performance. Modifying your vehicle for off-road use may result in the vehicle handling differently than a factory equipped vehicle. Extreme care must be used to prevent loss of control or vehicle rollover. Failure to drive your modified vehicle safely may result in serious injury or death. BDS Suspension Co. does not recommend the combined use of suspension lifts, body lifts, or other lifting devices. You should never operate your modified vehicle under the influence of alcohol or drugs. Always drive your modified vehicle at reduced speeds to ensure your ability to control your vehicle under all driving conditions. Always wear your seat belt.

BEFORE INSTALLATION

- Special literature required: OE Service Manual for model/year of vehicle. Refer to manual for proper disassembly/reassembly procedures of OE and related components.
- Adhere to recommendations when replacement fasteners, retainers and keepers are called out in the OE manual.
- Larger rim and tire combinations may increase leverage on suspension, steering, and related components. When selecting combinations larger than OE, consider the additional stress you could be inducing on the OE and related components.
- Post suspension system vehicles may experience drive line vibrations. Angles may require tuning, slider on shaft may require replacement, shafts may need to be lengthened or trued, and U-joints may need to be replaced.
- Secure and properly block vehicle prior to installation of BDS Suspension components. Always wear safety glasses when using power tools.
- If installation is to be performed without a hoist, BDS Suspension Co. recommends rear alterations first.
- Due to payload options and initial ride height variances, the amount of lift is a base figure. Final ride height dimensions may vary in accordance to original vehicle attitude. Always measure the attitude prior to beginning installation.



Visit 560plus.com for more information.

TIRES AND WHEELS

35 x 12.50 R17, R18, or R20 Tire
4-1/2" Backspace Wheel



BEFORE YOU DRIVE

Check all fasteners for proper torque. Check to ensure for adequate clearance between all rotating, mobile, fixed, and heated members. Verify clearance between exhaust and brake lines, fuel lines, fuel tank, floor boards and wiring harness. Check steering gear for clearance. Test and inspect brake system.

Perform steering sweep to ensure front brake hoses have adequate slack and do not contact any rotating, mobile or heated members. Inspect rear brake hoses at full extension for adequate slack. Failure to perform hose check/ replacement may result in component failure. Longer replacement hoses, if needed can be purchased from a local parts supplier.

Perform head light check and adjustment.

Re-torque all fasteners after 500 miles. Always inspect fasteners and components during routine servicing.

CONTENTS OF YOUR KIT

013205 Box Kit

| Part # | Qty | Description |
|--------|-----|-----------------------------|
| 03945 | 1 | 1-3" Track Bar Bracket |
| 02019 | 2 | Track Bar Cam |
| 232681 | 1 | Ford Alignment Cam- 2.3 deg |
| 232691 | 1 | Ford Alignment Cam- 2.6 deg |

033202 Box Kit

| Part # | Qty | Description |
|---------|-----|--------------|
| 033202R | 2 | Coil Springs |

TECH TIPS

TROUBLESHOOTING INFORMATION FOR YOUR VEHICLE

1. The factory front track bar bolt requires 405 ft-lbs of torque to be installed properly. Be sure you have the means of removing and installing this hardware properly. It is possible to install the hardware and torque to a more modest range (200 ft-lbs or so) and take the vehicle to a shop with the means to torque the hardware properly immediately after the installation is complete.
2. As a result of the location of the long radius arm suspension, support locations are limited. Use your best judgment while supporting the vehicle with sufficient strength stands at appropriate locations. The radius arms will need to move freely during this installation. Recommended to lift the front of the vehicle from the front body mount (An extension may be needed)
3. **2024+ Ford Super Duty Only:** This kit includes ball joint cams to achieve optimum performance both on and off-road. For vehicles equipped with non-selectable passenger side hub-lock on the front axle along with these ball joint cams, it is required to replace the non-selectable with a selectable hub-lock. Part number (PC3Z-3B396-A) is needed to prevent a grinding noise from the front axle for these applications. If your vehicle is not factory equipped with them, see **Figure A**. You may also need vacuum lines (3C125-A and/or 3C124). You can reference Section 307-07A of the Workshop Manual or Bulletin SSM 52423 for more information. For trucks with the vacuum tube as shown in **Figure B**, this step is not needed.

FIGURE A



FIGURE B

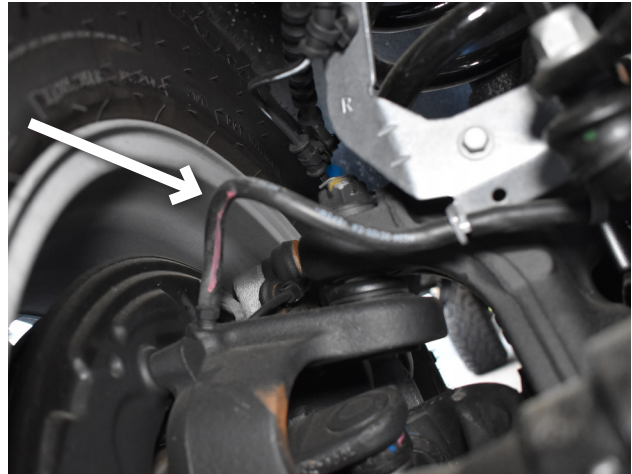

PRE INSTALLATION

IMPORTANT

It is required that ride height measurements be taken before and after installation. Measure from the **WHEEL AXLE CENTER** up to the **FENDER LIP** of the wheel opening. Do this for all 4 wheels. Record measurements below.**

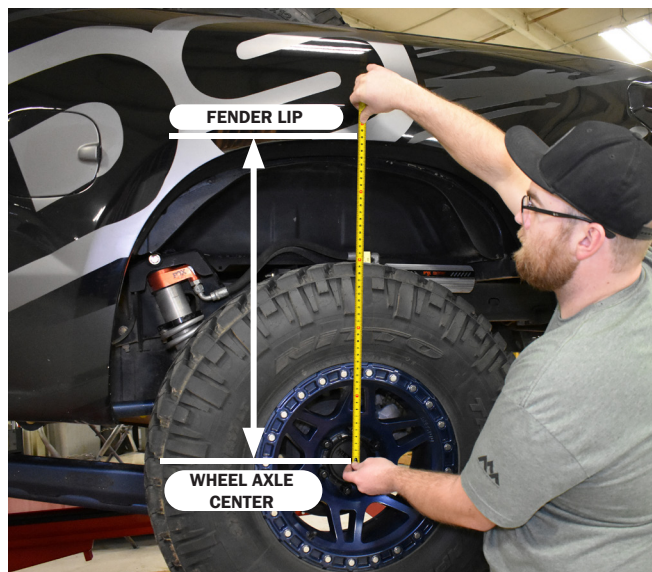

BEFORE

Left Front _____ Right Front _____

Left Rear _____ Right Rear _____

AFTER

Left Front _____ Right Front _____

Left Rear _____ Right Rear _____

****These ride heights will be required if you have any ride height concerns after installation. Please be prepared to provide these to Technical Support.**

INSTALLATION INSTRUCTIONS

SPECIAL TOOLS

INSTALLATION INSTRUCTIONS

1. Park the vehicle on a clean, flat surface and block the rear wheels for safety.
2. Disconnect the front track bar from the frame mount (Fig 1).

SPC #41550 or equivalent

Large Torque Wrench, ability to torque to 406 ft-lbs

30mm (1-3/16") Socket

FIGURE 1



3. Raise the front of the vehicle and support under the frame rails with jack stands.

Note: As a result of the location of the long radius arm suspension, support locations are limited. Use your best judgment while supporting the vehicle with sufficient strength stands at appropriate locations. The radius arms will need to move freely during this installation.

4. Remove the front wheels.
5. Support the front axle with a hydraulic jack. With the axle supported this installation can be performed on both sides at the same time, but is not necessary.
6. Disconnect the sway bar links from the axle mounts. Retain hardware.
7. Remove the OE shock. Retain lower mounting hardware.
8. Disconnect the brake line bracket from the front of the coil perch (Fig 2). Retain hardware.

FIGURE 2

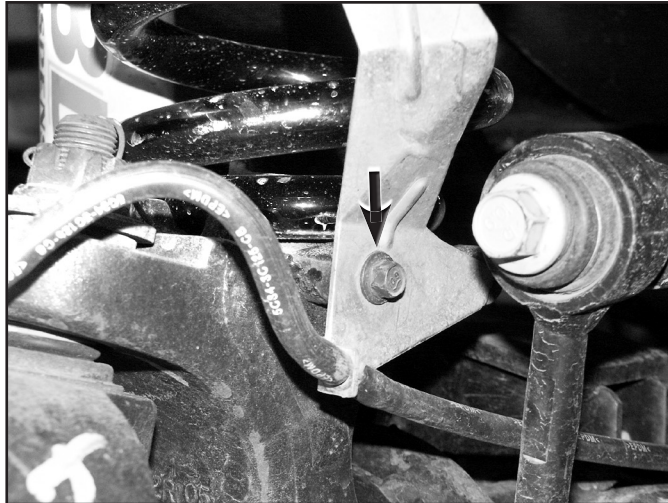

9. Free the hub vacuum line from the axle (Fig 3, 4).

FIGURE 3

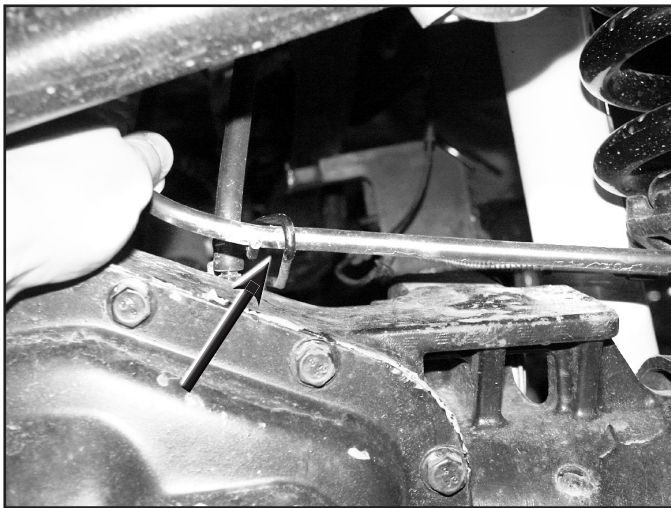

FIGURE 4



10. Lower the axle until the spring is free and remove the spring from the vehicle.

Note: Do not over extend the brake lines.

11. Remove the five bolts mounting the track bar bracket to the frame and remove the bracket from the vehicle (Fig 5).

FIGURE 5



12. Install the new bracket in the vehicle using the five original mounting holes and hardware. Torque mounting hardware to 129 ft-lbs (Fig 6).

FIGURE 6

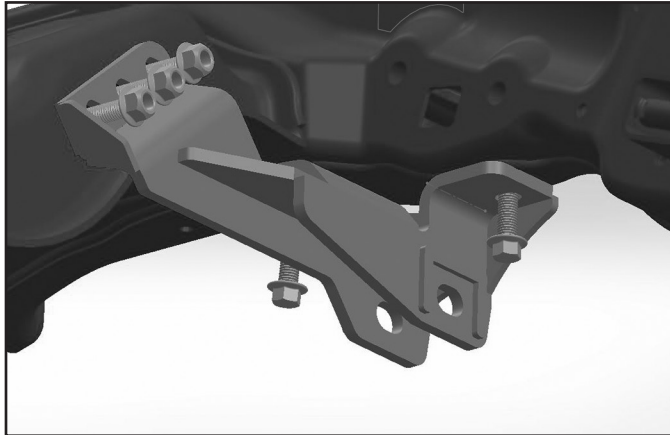

13. Transfer the upper coil isolators to the new springs. Install the new coil springs and index correctly in the coil perch.
14. Grease and install sleeves and bushings into the shocks.
15. BDS (Silver / non-Fox) shocks will require the lower mount to be modified. The sharp, non-formed edge will need to be ground to match the formed profile. Grind this and coat with paint. (Fig 7a, 7b)

FIGURE 7A

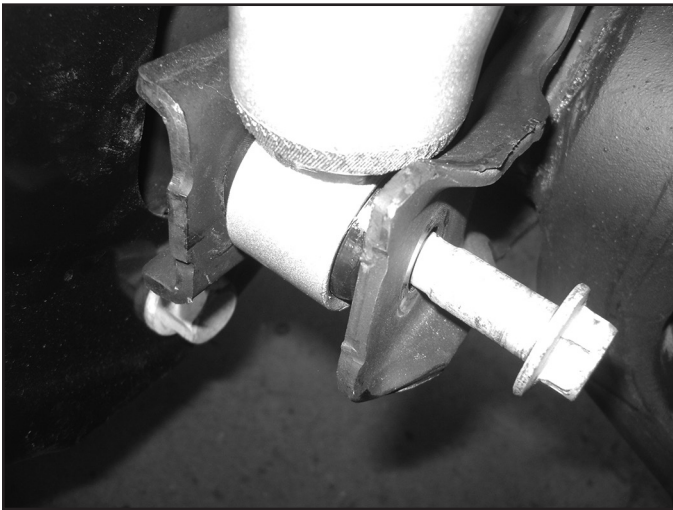
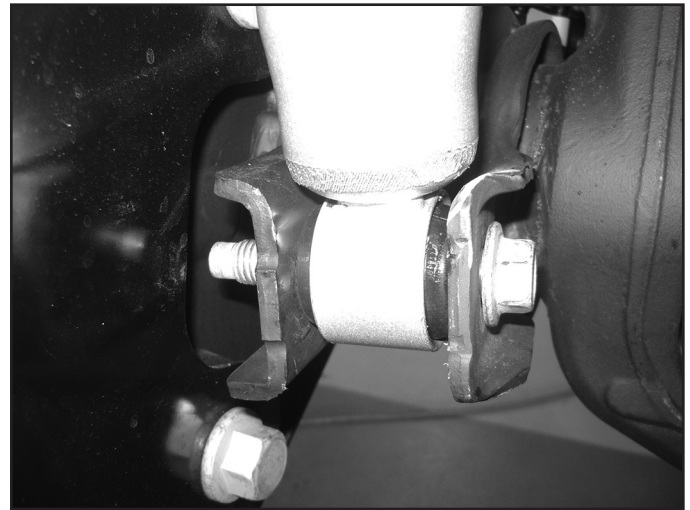

FIGURE 7B



16. Compress the coils slightly by using a hydraulic jack on the axle. Install new shocks with factory lower hardware and stem washers, bushings, and 1/2" fine thread nut on the upper mount. Tighten the upper mount until the bushings begin to swell. Tighten lower mount to 50 ft-lbs.
17. Reattach all brake, ABS and vacuum lines to the original locations with the OE mounting hardware.
18. Reattach the sway bar links to the axle with the OE hardware and tighten securely.

ALIGNMENT CAM INSTALLATION

19. Remove the cotter pin from the upper ball joint.
20. Loosen the upper ball joint stud until the nut is level with the top of the stud. Strike the axle "ear" near the upper ball joint to release the ball joint to sleeve taper (Fig 8a).

Note: The top of the stud can also be struck using a soft blow hammer to aid in loosening the taper. Take care not to damage the stud/nut threads.

FIGURE 8A



21. Remove the OE ball joint sleeve from the axle using the appropriate removal tool (SPC #41550 or equivalent) (Fig 8b).

FIGURE 8B



22. Install the new sleeve with the arrow on the top of the sleeve pointing toward the front of the vehicle. 2 different sleeves are included. The sleeve marked "2.3 degrees" should be used on the driver's side and the sleeve marked 2.6 degrees should be used on the passenger's side. Using the old sleeve, pound down on the new sleeve to seat it on the ball joint taper. Make sure that the flat of the sleeve is flush with the flat of the axle (Fig 9).

FIGURE 9



23. Install and torque the OE ball joint nut to 69 ft-lbs. Install the cotter pin. Note: Do not loosen the nut to install the cotter pin (Fig 10).

FIGURE 10



24. Install the wheels and lower the vehicle to the ground.

25. Reattach the track bar with the OE hardware. Turn the steering wheels to aid in aligning the track bar in the bracket. Torque hardware to 406 ft-lbs.

Install the offset the holes in the cams closer to the passenger's side, opposite as shown in (Fig 11)

FIGURE 11 (DRIVER SIDE INSTALLATION SHOWN)

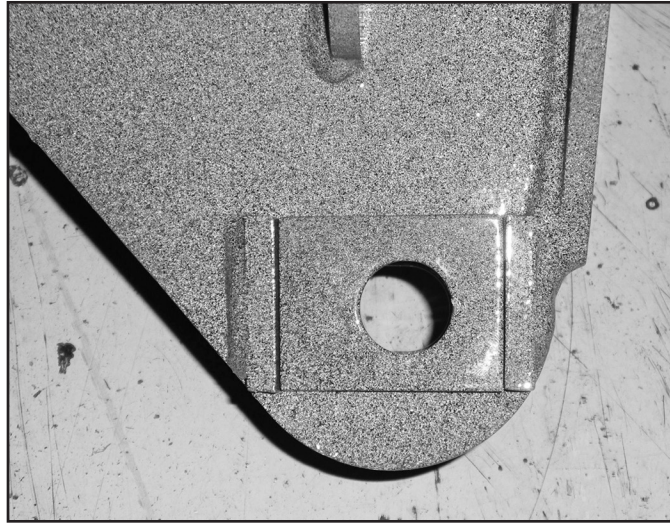

26. Check all hardware for proper torque.
27. Adjust steering wheel.
28. Check hardware after 500 miles.



WE WANT TO SEE YOUR RIDE!

Grab photos of your BDS-equipped truck in action and send them in for a chance to be featured. Send it in to our Bad Ass Rides customer gallery at bds-suspension.com/bar and post them on the BDS Fan Page on Facebook at facebook.com/BDSSuspensions. Don't forget about your BDS swag! BDS offers t-shirts, hoodies, decals and more available on the BDS website or through your local BDS distributor.

TIME TO HAVE SOME FUN

Thank you for choosing BDS Suspension.

For questions, technical support and warranty issues relating to this BDS Suspension product, please contact your distributor/installer before contacting BDS Suspension directly.