

INSTALLATION GUIDE



Part#: 121655



HARDCORE LIMITED LIFETIME WARRANTY

6" MagneRide Suspension Systems

GMC Denali 1500 4WD Pickup | 2014-2018

Rev. 122920

491 W. Garfield Ave., Coldwater, MI 49036 • Phone: 517-279-2135

Web: www.bds-suspension.com • E-mail: tech-bds@ridefox.com

Read And Understand All Instructions And Warnings Prior To Installation Of System And Operation Of Vehicle.

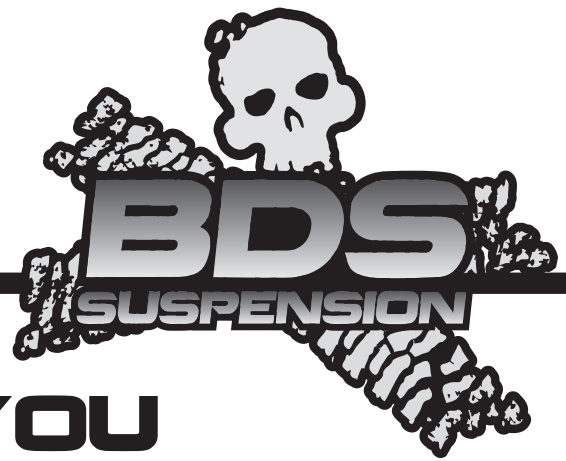

THANK YOU

Your truck is about to be fitted with the best suspension system on the market today. That means you will be driving the baddest looking truck in the neighborhood, and you'll have the warranty to ensure that it stays that way for years to come. Thank you for choosing BDS Suspension!

BEFORE YOU START

BDS Suspension Co. recommends this system be installed by a professional technician. In addition to these instructions, professional knowledge of disassembly/ reassembly procedures and post installation checks must be known.

FOR YOUR SAFETY

Certain BDS Suspension products are intended to improve off-road performance. Modifying your vehicle for off-road use may result in the vehicle handling differently than a factory equipped vehicle. Extreme care must be used to prevent loss of control or vehicle rollover. Failure to drive your modified vehicle safely may result in serious injury or death. BDS Suspension Co. does not recommend the combined use of suspension lifts, body lifts, or other lifting devices. You should never operate your modified vehicle under the influence of alcohol or drugs. Always drive your modified vehicle at reduced speeds to ensure your ability to control your vehicle under all driving conditions. Always wear your seat belt.

BEFORE INSTALLATION

Special literature required: OE Service Manual for model/year of vehicle. Refer to manual for proper disassembly/reassembly procedures of OE and related components.

Adhere to recommendations when replacement fasteners, retainers and keepers are called out in the OE manual.

Larger rim and tire combinations may increase leverage on suspension, steering, and related components. When selecting combinations larger than OE, consider the additional stress you could be inducing on the OE and related components.

Post suspension system vehicles may experience drive line vibrations. Angles may require tuning, slider on shaft may require replacement, shafts may need to be lengthened or trued, and U-joints may need to be replaced.

Secure and properly block vehicle prior to installation of BDS Suspension components. Always wear safety glasses when using power tools.

If installation is to be performed without a hoist, BDS Suspension Co. recommends rear alterations first.

Due to payload options and initial ride height variances, the amount of lift is a base figure. Final ride height dimensions may vary in accordance to original vehicle attitude. Always measure the attitude prior to beginning installation.

BEFORE YOU DRIVE

Check all fasteners for proper torque. Check to ensure for adequate clearance between all rotating, mobile, fixed, and heated members. Verify clearance between exhaust and brake lines, fuel lines, fuel tank, floor boards and wiring harness. Check steering gear for clearance. Test and inspect brake system.



Visit 560plus.com for more information.

TRACTION CONTROL

In an effort to reduce the risk of rollover crashes the National Highway Traffic Safety Administration (NHTSA) established the Federal Motor Vehicle Safety Standard (FMVSS) No. 126 requiring all new passenger vehicles under 10,000 lbs GVWR include an electronic stability control (ESC) system as standard equipment. Effective August 2012 this law requires aftermarket products to be compliant with these same standards.



TIRES AND WHEELS

FITMENT GUIDE

6.5" Lift:
33 x 12.50 on 17x8 w/ 4.5" BS
34 x 12.50 on 17x9, 18x9 w/ 5" BS
35 x 12.50 on 20x9 w/ 5.75" BS



Perform steering sweep to ensure front brake hoses have adequate slack and do not contact any rotating, mobile or heated members. Inspect rear brake hoses at full extension for adequate slack. Failure to perform hose check/ replacement may result in component failure. Longer replacement hoses, if needed can be purchased from a local parts supplier.

Perform head light check and adjustment.

Re-torque all fasteners after 500 miles. Always inspect fasteners and components during routine servicing.

CONTENTS OF YOUR KIT

021660 - Cast Steel Control Arms

021661 - Stamped Steel/ Aluminum Control Arms

Part #	Qty	Description
02845	1	Steering Knuckle - Drv (021660 only)
02846	1	Steering Knuckle - Pass (021660 only)
02847	1	Steering Knuckle - Drv (021661 only)
02848	1	Steering Knuckle - Pass (021661 only)
02487	2	Lower Ball Joint Spacer (021661 only)
401-2036	2	Tie Rod End - Pass

021662 Box Kit

Part #	Qty	Description
02478	1	Front Crossmember
02148	1	Rear Crossmember
02352	1	Differential Drop Bracket - Drv
02353	1	Differential Drop Bracket - Pass
A224	1	Differential Drop Bracket w/ Bushings
01165	2	CV Spacer
02166B	2	Sway Bar Drop (021662 only)
02492	2	Sway Bar Drop (021462 only)
21	2	5/8" x 5" Sway Bar Link Sleeve
4805G	8	Sway Bar Link Bushing
S10024	8	Sway Bar Link Washer
B389G5	2	3/8" x 9" bolt
37024	2	3/8" nylock nut
451	1	Bolt Pack - Sway Bar Drop (021642 only)
	4	10mm-1.50 x 80mm socket head cap screw
	4	10mm flat washer
621	1	Bolt Pack - LCA Bolts
	2	5/8"-11 x 4-1/2" bolt
	2	5/8"-11 x 5-1/2" bolt
	4	5/8"-11 lock nut
	8	5/8" SAE washer
568	1	Bolt Pack - CV Spacers
	12	10mm-1.5 x 70mm SHCS
446	1	Bolt Pack - Differential Brackets
	2	1/2" x 1-3/4" bolt
	2	1/2"-13 lock nut
	4	1/2" SAE washer
	1	5/8" x 1-3/4" bolt
	1	5/8" SAE Thru hardened extra thick washer
	1	5/8" SAE washer
	1	5/8"-11 lock nut
	2	9/16"-12 x 4" bolt
	4	9/16" SAE flat washer
	2	9/16"-12 lock nut
	4	10mm-1.50 x 40mm bolt
	4	10mm washer

021663 Box Kit

Part #	Qty	Description
02186B	1	Front Skid Plate
02479	1	Skid Plate - Drv
02480	1	Skid Plate - Pass
02169	1	Weld-in Plate
02115	1	Front Brake Line Bracket - Drv
02116	1	Front Brake Line Bracket - Pass
099000	7	Cable Tie
448	1	Bolt Pack - ABS/Skid Plate
	4	Wire Clip
	2	1/4" x 3/4" self tapping bolt
	8	1/2" x 1-1/4" Bolt
	8	1/2" SAE Washer
449	1	Bolt Pack - Sway Bar Drop
	4	10mm-1.50 x 120mm Socket Head Cap Screw
	4	10mm Flat Washer
342701	1	Loctite

121655 MagneRide Box Kit

Part #	Qty	Description
02938	2	MagneRide Rear Shock Bracket
02939	2	MagneRide Nut Tab
02940	1	Driver MagneRide Front Sensor
02941	1	Pass. MagneRide Front Sensor
02316	2	6.5" Strut Spacer
B1168	1	MagneRide Bag Kit
342701	1	Loctite
979	1	Bolt Pack - Rear Shock Brackets
	2	9/16"-12 x 3" Bolt
	4	9/16" SAE Washer
	2	9/16"-12 Lock Nut
	2	1/2" - 13 x 1-1/2" Bolt
	2	1/2" SAE Washer
980	1	Bolt Pack - Front Sensor
	2	M6-1.00 Prevailing Torque Nut - Clear Zinc
	2	1/4"-20 x 1" Bolt
	4	1/4" SAE Washer
	2	1/4"-20 Lock Nut
	4	Wire Clip
629	1	Bolt Pack - Strut Spacer
	6	10mm-1.50 Lock Nut
	6	3/8" USS Washer

011505 Rear Box Kit

Part #	Qty	Description
5FB-W96	2	5" Lift Block (011505)
UBT4145	4	9/16" x 2-9/16" x 12-1/2" square u-bolt (block kits)
3396	2	Rear Bump Stop Spacer
628	1	Bolt Pack - Bump Stop/ Rear Brake Bracket
	1	5/16" x 1 bolt
	1	5/16" lock nut
	2	5/16" SAE Washer
	2	10mm x 110mm Allen head bolt
SBLA	1	Rear Brake Line Bracket

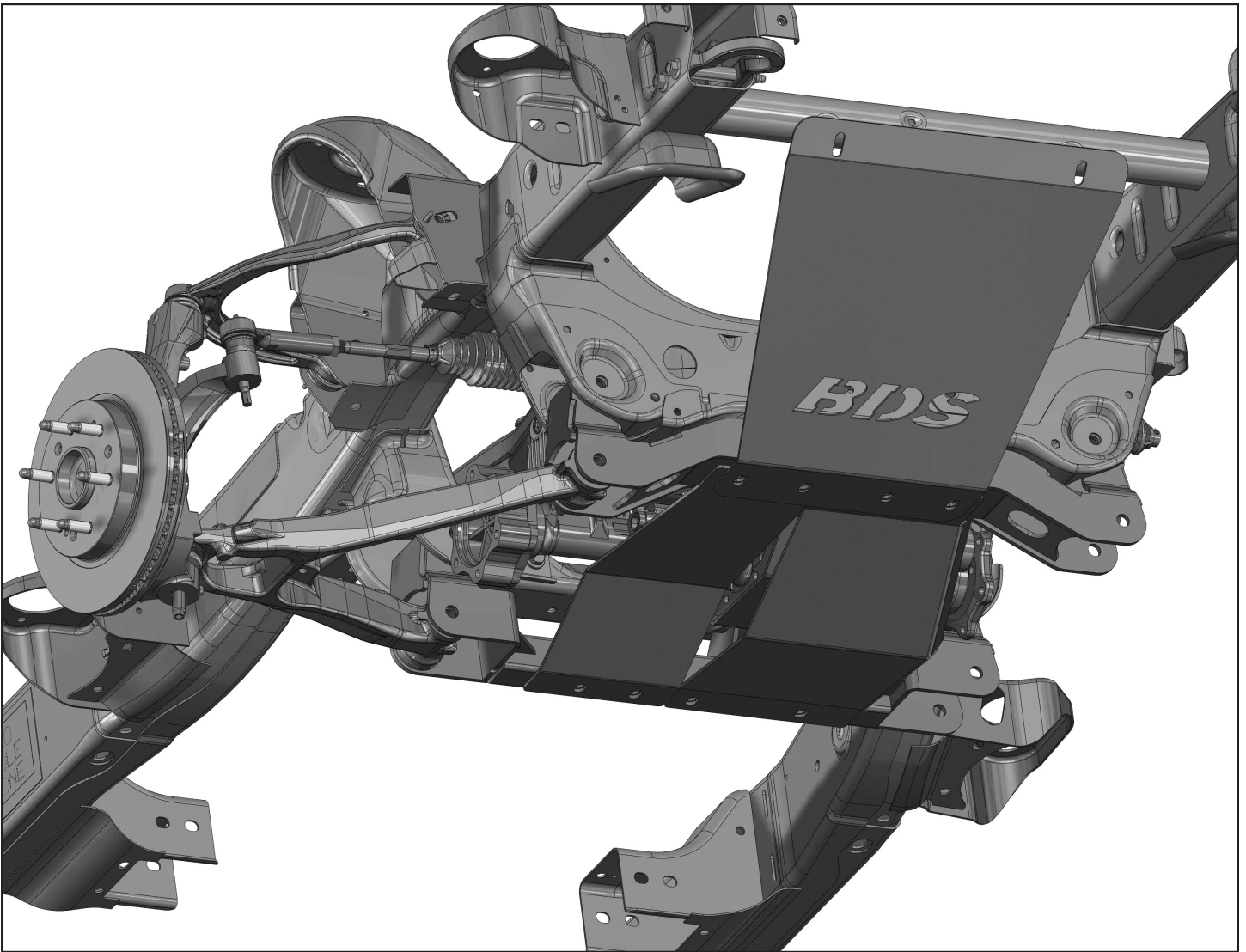

TROUBLESHOOTING INFORMATION FOR YOUR VEHICLE

1. Requires frame bracket and differential modification.
2. 20" wheels with 5-3/4" backspacing recommended to reduce trimming.
3. Trucks with stock aluminum steering knuckles will require 021661 box kit instead of 021660.

**TECH
TIPS**

INSTALLATION INSTRUCTIONS

MEASURE FIRST

Measure from the center of the wheel up to the bottom edge of the wheel opening:

LF _____ RF _____

LR _____ RR _____

SPECIAL TOOLS

36mm Socket - Hub Nut

DO YOU KNOW IF YOUR TRUCK HAS STEEL OR ALUMINUM STEERING KNUCKLES?

Verify whether the truck has steel or aluminum steering knuckles. This kit is specific for each type of steering knuckles due to differences in balljoint taper. Using the parts list verify you have the correct knuckle box kit for your truck. The knuckles also are marked with the part numbers listed.

RECALL NOTICE

GM issued a safety recall (#42190) for some 2016-17 vehicles built before 4/8/16 that were equipped with stamped steel upper control arms due to poor weld quality. BDS strongly recommends checking if your vehicle is included in the recall and having the fix performed before installing this suspension system.

WELDING IS REQUIRED

The installation of this kit requires minor welding of a reinforcement plate. We recommend this procedure be performed by an experienced welder. If necessary, this kit can be completely installed and then driven to a shop to have the plate welded. This method will make reaching the weld locations slightly more difficult but it can be done if necessary.

FRONT DISASSEMBLY

1. Park the vehicle on a clean, flat surface and block the rear wheels for safety.
2. Disconnect the positive and negative battery cables from the battery.
3. Raise the front of the vehicle with a hydraulic jack and support the frame with jack stands. Remove the wheels.
4. Remove the ABS line from the retaining clips at the frame, upper control arm and knuckle (Fig 1A). Using a 10mm wrench, unthread the MagneRide sensor from the stock bracket on the upper control arm and move the sensor arm up out of the way (Fig 1B). Remove the brake line from the bracket on the upper control arm. A set of Vise Grips works best to bend the bracket (Fig. 1C & 1D). Remove the stock brake line bracket from the upper control arm and save the bolt.

FIGURE 1A

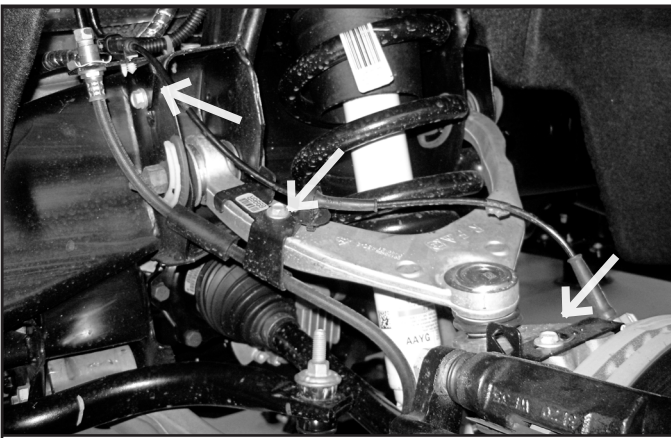

FIGURE 1B

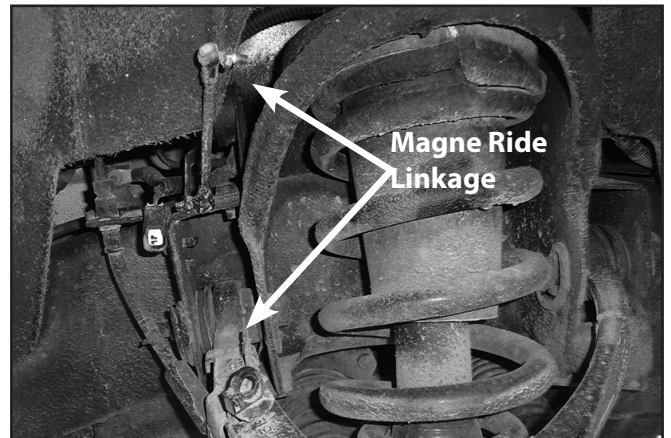

FIGURE 1C

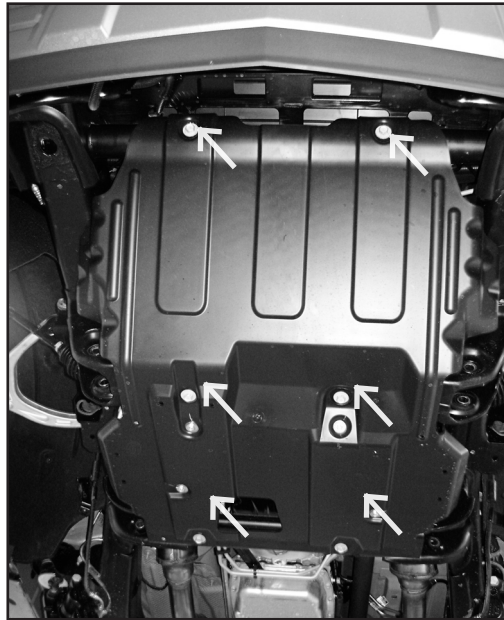

FIGURE 1D



5. Remove the splash guard from the vehicle. (Fig 2)

FIGURE 2



6. Disconnect the tie rod from the knuckle (Fig. 3). Remove the tie rod end nut. Steel Knuckle: Strike the knuckle near the tie rod end with a hammer to unseat the taper. Aluminum Knuckle: Avoid striking the knuckle, typically the taper unseats more easily and gently hitting the end of the tie rod end will unseat the taper. A pickle fork can also be used. Save the mounting nut.

FIGURE 3

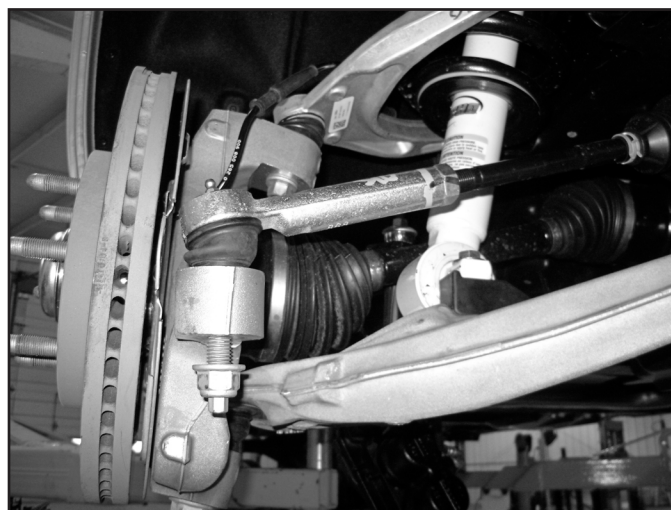

7. Remove the two brake caliper mounting bolts and remove the caliper from the knuckle (Fig. 4). Hang the caliper securely out of the way DO NOT hang the caliper by the brake hose. Save caliper bolts.

FIGURE 4



8. Remove the brake rotor retaining bolt and remove the rotor from the vehicle.
9. Remove the hub dust cap (Fig. 5). Remove the axle shaft nut. Retain nut and cap.

 **Tip** Use a small chisel and hammer to carefully separate the edge of the cap from the hub. Work around the circumference of the cap. The axle nut will require a 36mm socket.

FIGURE 5



10. Remove the sway bar links from the sway bar and the lower control arm (Fig. 6).

FIGURE 6

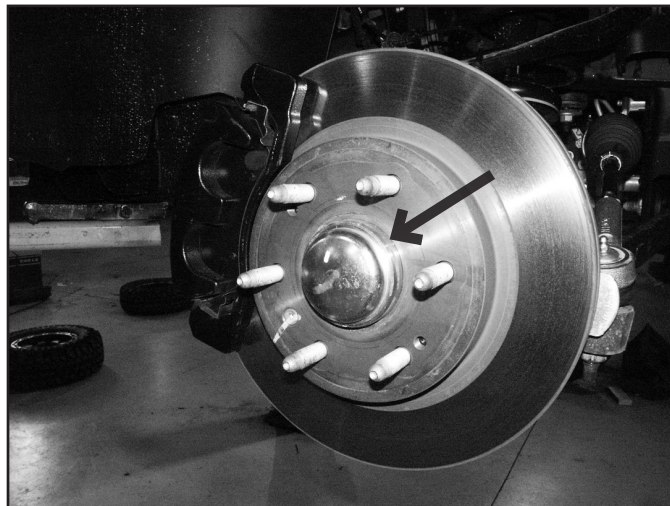
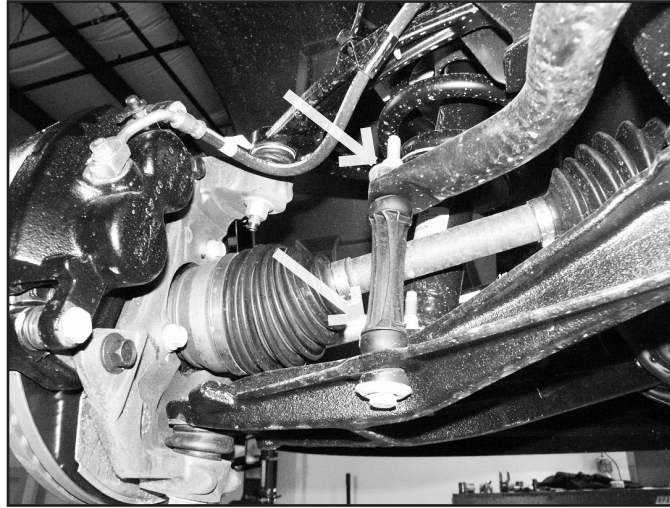

11. Mark the orientation of the sway bar and remove it from the frame by removing the four bushing cap mounting bolts (Fig. 7). Save all sway bar components.

FIGURE 7



12. Mark each of the front strut bodies to indicate driver's versus passenger's side.
13. Support the lower control arm with a jack. Remove the lower strut mount bolts (Fig. 8). Save bolts.

FIGURE 8

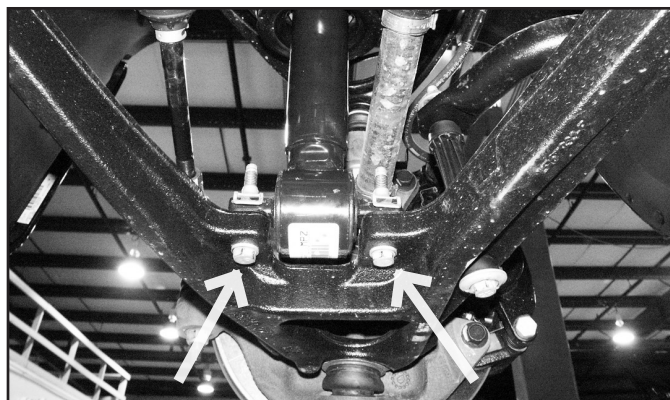

14. Remove the CV shaft mounting flange bolts (6 per side) (Fig. 9). Mark the shaft to indicate driver's or passenger's side. Bolts will not be reused.

FIGURE 9

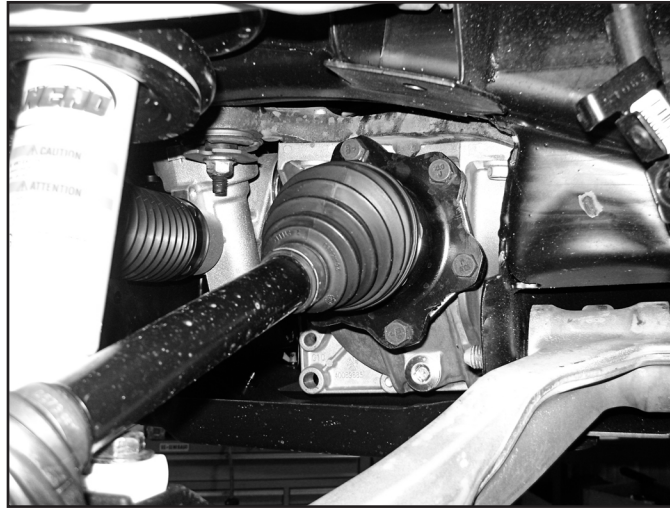

15. Remove the upper and lower ball joint nuts and thread back on by hand a couple of turns. **Steel Knuckle:** Strike the knuckle near the upper and lower ball joints to dislodge the tapered seat. **Aluminum Knuckle:** Avoid striking the knuckle to release the taper, a pickle fork or pry bar can be used to apply a splitting force. Gently hit the end of the ball joint to get it to release. If you do resort to hitting the knuckle avoid re-use and discard.
16. Remove the upper ball joint nut and lower the lower control arm down. Remove the CV shaft from the hub and set aside. Remove the lower ball joint nut and remove the knuckle assembly from the lower control arm. Save ball joint nuts.
17. Remove the three upper strut mounting nuts (Fig. 10A), disconnect the MagneRide wire harness connector from the top of the strut (Fig. 10B), and remove the strut from the vehicle. DO NOT remove the center strut rod nut, it is under extreme pressure. Save nuts. *Note: Do not remove the MagneRide wiring harness from the top of the strut, disconnect the wire harness coming out of the strut that is attached to the main wire harness on the vehicle.*

FIGURE 10A

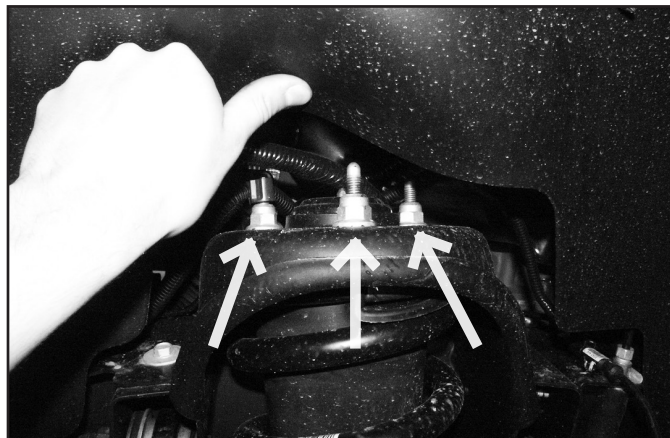
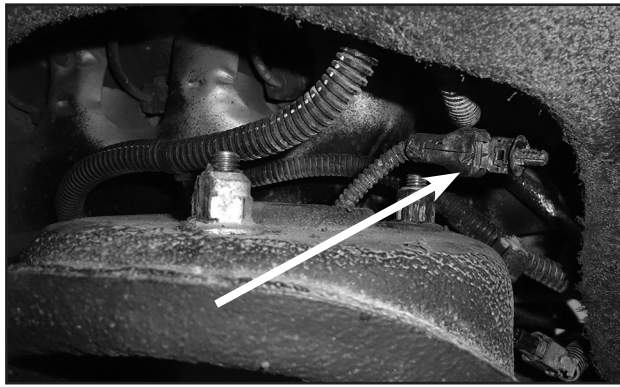
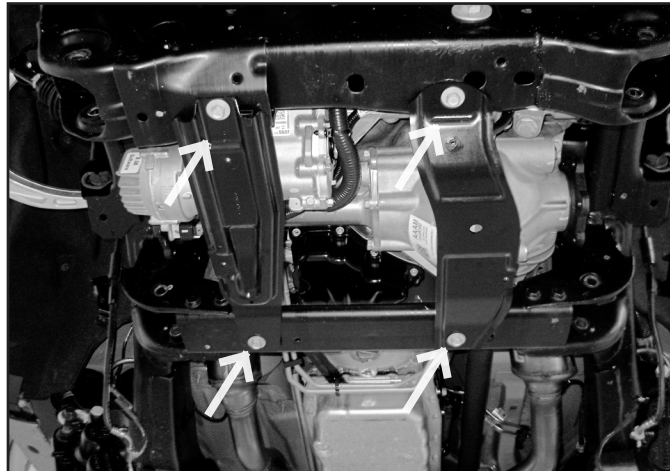

FIGURE 10B



18. Remove the front and rear lower control arm mounting bolts and remove the lower control arm from the vehicle. Save mounting hardware and control arms.
19. Remove the crossmember struts. (Fig 11)

FIGURE 11



20. Remove the factory rear crossmember from the vehicle by removing the 4 bolts. (Fig 12) Crossmember and hardware will not be reused.

FIGURE 12

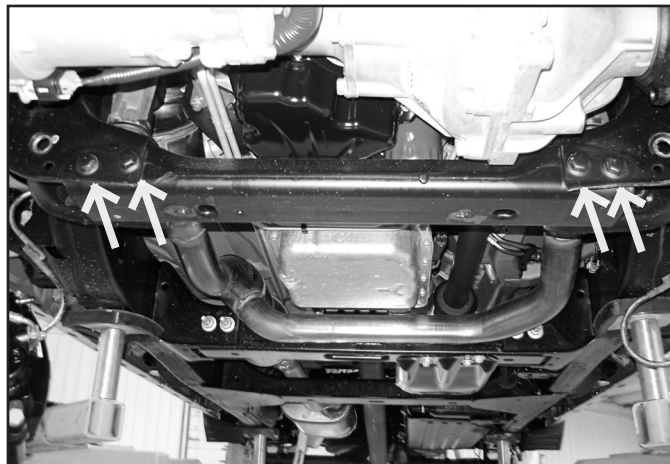

21. Make an alignment mark to show the relationship between the front driveshaft and the differential yoke. Remove the four driveshaft bolts and disconnect the driveshaft from the differential. Save bolts. (Fig. 13)

FIGURE 13



22. The driver's side rear lower control arm pocket must be cut to provide clearance for the front differential in the relocated position. This also aids in the removal of the differential. This area needs to be cleaned of any oil, grease and/or undercoating. These coatings are flammable.



Tip A putty knife and parts cleaning solvent work well to remove undercoating.

23. Measure from the inside of the driver's side control arm pocket out 3-1/2" and mark. Repeat this measurement on the opposite side of the pocket. Make vertical cut lines at the 3-1/2" mark up both front and back faces of the pocket (Fig. 14).

FIGURE 14 - SHOWN WITH DIFFERENTIAL REMOVED FOR CLARITY

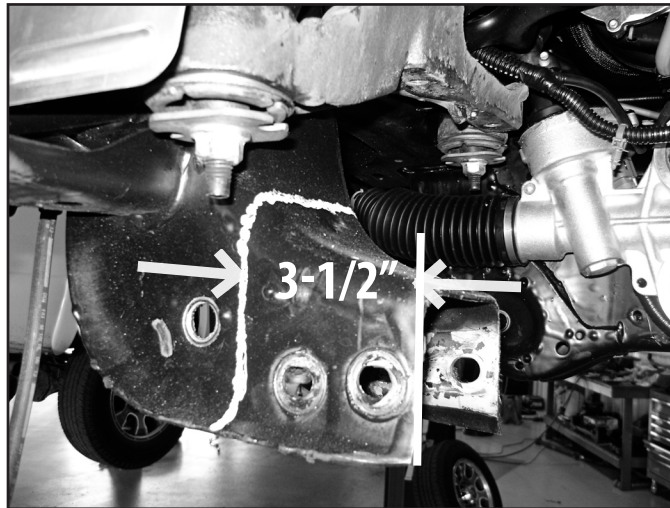

24. Make a vertical cut along each of the cut lines on the front and back faces of the control arm pocket with a reciprocating saw (recommended), cut-off wheel or plasma cutter. Be careful, the undercoating on the frame is flammable and can melt and drip off the frame. Keep a fire extinguisher near by.
25. With the vertical cuts complete, cut the top portion of the pocket by connecting the two cuts.
26. Disconnect the differential actuator wire connector from the actuator (Fig. 15). Remove the three wire harness clips holding the actuator harness to the differential housing.



Tip If you are having difficulty accessing the plug, wait until the differential is being lowered to disconnect it.

FIGURE 15



27. Disconnect the differential breather hose (Fig. 16).

FIGURE 16

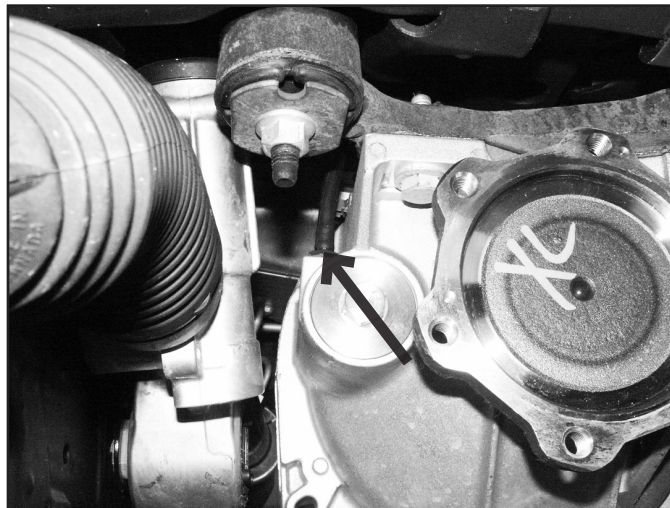

28. Support the front differential with an appropriate jack. Remove the two driver's side differential mounting bolts (Fig. 17) and the two passenger's side mounting nuts. Carefully lower the differential to the ground. Save mounting hardware.



Tip

We highly recommend having an assistant to help with removal of the front differential.

FIGURE 17

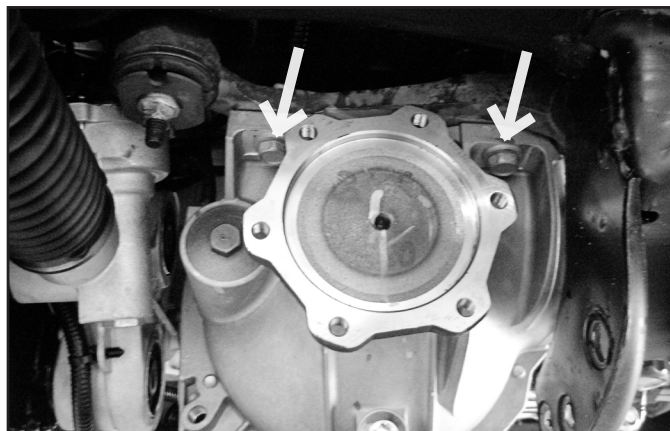

DIFFERENTIAL MODIFICATION

29. The differential housing needs to be modified to clear the electronic steering rack in the relocated position. Mark the passenger side mount as shown in figure 18 and using a reciprocating saw make 2 cuts perpendicular to the mounting surface. (Fig. 19)

FIGURE 18

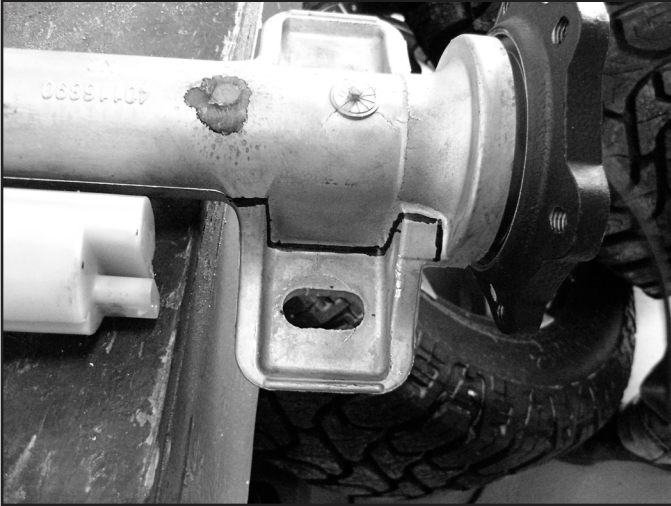
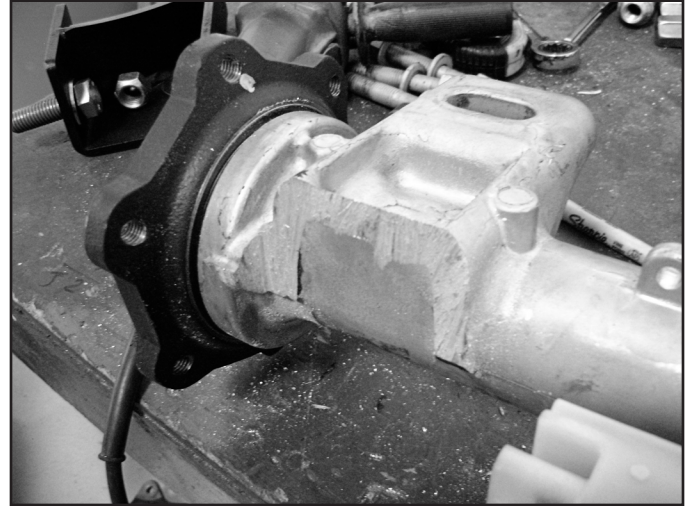
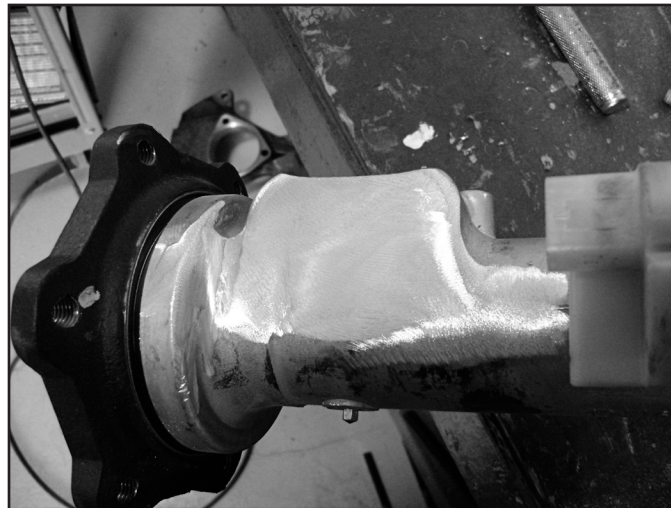

FIGURE 19



30. Clean up the cuts with a sanding disc or flap wheel. Be sure to remove the remaining material on the outside flange so it matches the rest of the contour. (Fig. 20)

FIGURE 20



31. The rear side of this mount also needs to be trimmed. Measure 1 inch from the center of the slot and mark a cut line. (Fig 21A) Using a reciprocating saw, cut at the line. (Fig. 21B).

FIGURE 21A

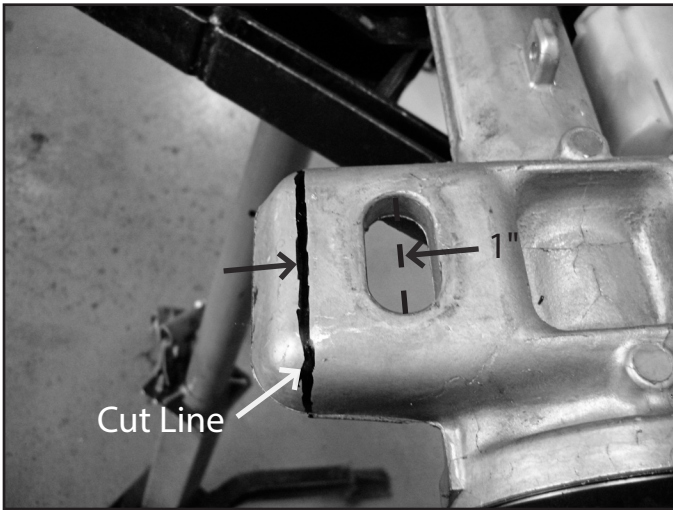
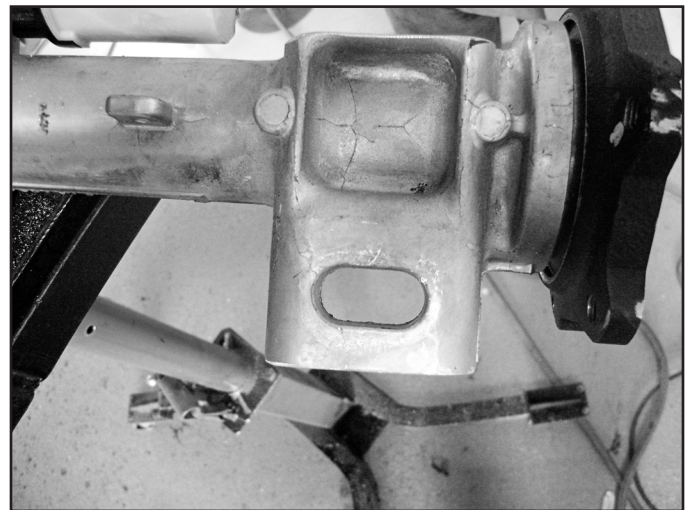

FIGURE 21B



32. The lower tab of the differential will need to be trimmed to clear the high clearance skid plates as shown in Figures 22A, B.

FIGURE 22A

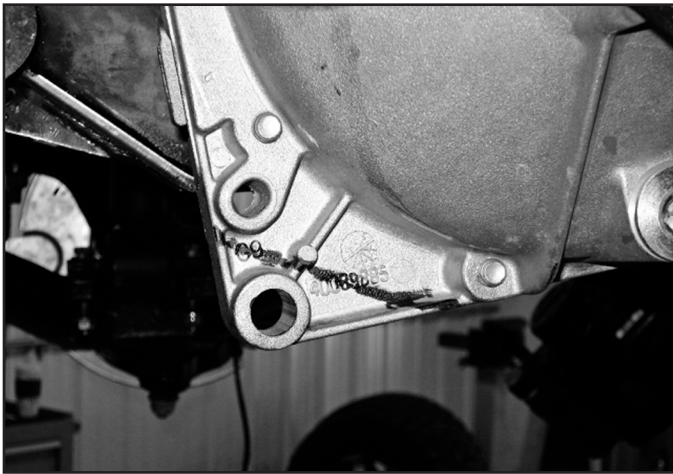

FIGURE 22B



33. Locate the center differential bracket and 10mm x 40mm bolts and washers. Remove the 4 housing bolts and install the differential bracket with the provided hardware using some loctite. Torque bolts to 33 ft-lbs. Take care not to break the gasket seal. (Fig. 23)

 **Tip** *Differential mount hardware is located in bolt pack 446.*

FIGURE 23

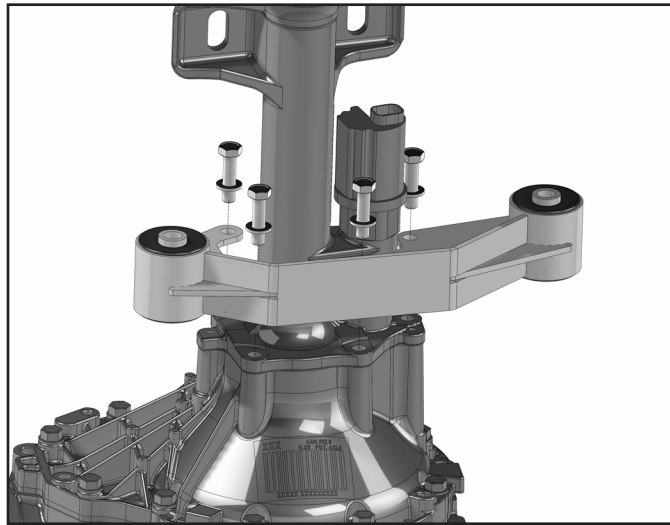

DIFFERENTIAL INSTALLATION

34. Place the provided weld-in plate up against the cut edge of the control arm pocket. The plate should be flush with the bottom edge of the pocket and overhang the front and back outside surfaces an equal amount. The chamfered corner of the plate should be in the top-front position (Fig. 24). Tack weld the plate in place.



Tip *Welding should be performed by an experienced welder. See pre-installation notes at the beginning of these instructions.*

FIGURE 24



35. With the plate tacked, go back and weld the plate in place. Weld along the OUTSIDE of the pocket on the vertical surfaces. Welding on the inside will result in crossmember interference. Weld along the top edge of the plate on the inside of the pocket. Once the area has cooled, paint all exposed metal to prevent corrosion.
36. The rear control arm pocket flanges need to be trimmed for CV shaft clearance. Cut the flange so it is approx. 3/8" from the inside face of the control arm pocket. Verify there is enough clearance once the CV spacers are installed. (Fig. 25, 26)

**FIGURE 25 - SHOWN WITH DIFFERENTIAL
TO SHOW CLEARANCE**

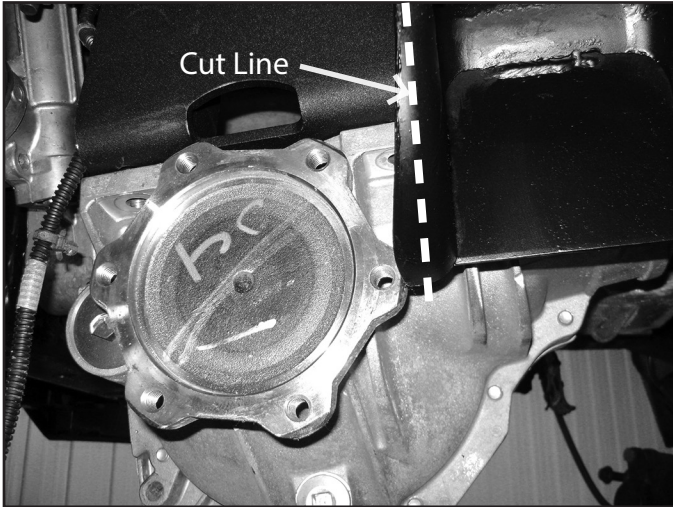

**FIGURE 26 - SHOWN WITH DIFFERENTIAL
TO SHOW CLEARANCE**

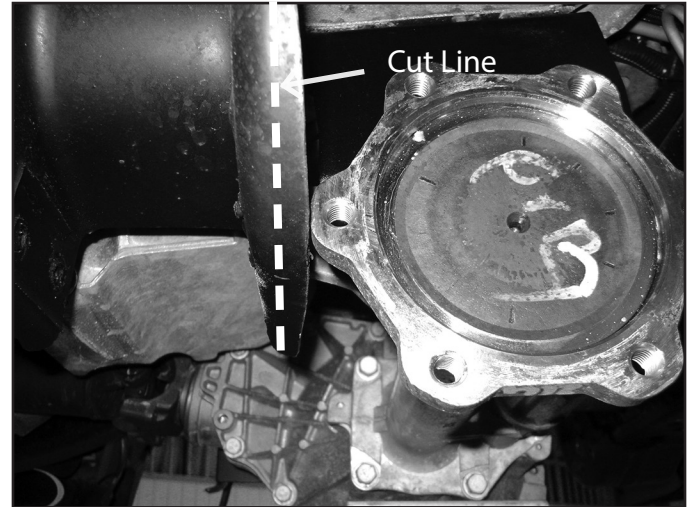

37. Install the new driver's side differential bracket to the original mount with the factory bolts (Fig. 27). The side with the formed end mounts to the OE mount and the open face points toward the inside of the vehicle. Torque bolts to 65 ft-lbs.

FIGURE 27 - SHOWN WITH DIFFERENTIAL ALREADY INSTALLED



38. Install the new passenger's side differential bracket to the original mounting studs with the factory nuts (Fig. 28). The bracket is cleared for the electronic steering rack and mounts with the open face toward the inside of the vehicle. Torque nuts to 65 ft-lbs.

FIGURE 28 - SHOWN WITH DIFFERENTIAL ALREADY INSTALLED

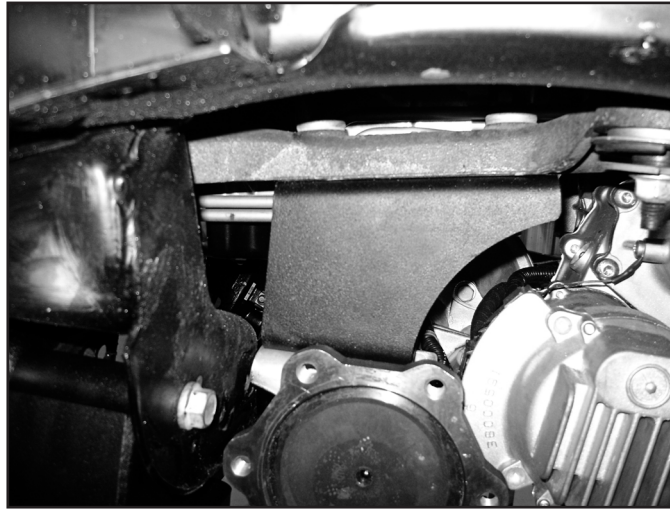

39. Install the differential to the new driver's and passenger's differential brackets. Fasten the differential to the driver side bracket with $\frac{1}{2}$ " x 1-3/4" bolts, nuts and washers. Use the 5/8" bolt, 5/8" SAE washer and one extra thick 5/8" washer on the passenger's side. The extra large washer will go against the differential housing flange with the large slots. Leave hardware loose.



Tip Hardware for the differential drop brackets is located in bolt pack 446.

40. Reconnect the differential actuator wiring. Reattach the wire to the differential housing with the factory clips.
41. Reconnect the differential breather line. The line will need to be removed from retaining clips above to gain slack.



Tip The breather line may need to be accessed through the engine compartment to be rerouted for more slack.

42. Reconnect the front drive shaft to the differential as it was removed with the original hardware. Torque bolts to 19 ft-lbs.
43. Install the new rear crossmember with the factory lower control arm bolts, nuts and washers. The tabs on the crossmember should align with the center diff. bracket. Run the bolts from front to rear. Leave hardware loose.
44. Install the front crossmember in the control arm pockets with the factory lower control arm bolts, nuts and washers. When installed, the tabs will align with the center differential mount. Run bolts from front to rear. Leave hardware loose.
45. Install the 9/16" x 4" bolts in the center differential bracket at the front and rear crossmembers. Torque all differential mount hardware: 1/2" hardware to 65 ft-lbs, 9/16" hardware to 90 ft-lbs and the 5/8" hardware to 120 ft-lbs.
46. Loosely attach the differential skid plates to the rear crossmember with four 1/2" x 1-1/4" bolts and 1/2" SAE washers in the threaded holes in the crossmembers. Install the front skid plate to the frame with the factory hardware. The differential skid plates will sandwich between the front skid plate and front crossmember also using 1/2" x 1-1/4" bolts. Use Loctite on all skid plate bolts. Leave hardware loose. (Fig. 29)



Tip Hardware for the differential skid plate and crossmember support strut is located in bolt pack 448

FIGURE 29



47. Install the OE lower control arms in the new crossmembers and fasten with 5/8" x 4-1/2" (front) and 5/8" x 5-1/2" (rear) bolts, nuts and 5/8" SAE washers. Run the bolts from front to rear. Leave hardware loose.



Tip Hardware for the lower control arms is located in bolt pack 621.

48. With the crossmembers, control arms, skid plate and support strut installed, go back and torque the crossmember mounting bolts to 125 ft-lbs and the skid plate hardware to 65 ft-lbs.
49. Install the provided strut spacers on the struts with provided nuts and washers. Run the wire harness for the MagneRide strut up through the center of the strut spacer. The spacers will only install one way. Torque the hardware to 30 ft-lbs.
50. Gain adequate slack from the wire harness on the frame for the MagneRide system to connect the wire harness on the frame to the MagneRide wire harness on the strut. The wire harness may need to be unclipped from the frame rail.
51. Reconnect the wire harness for the MagneRide system on the vehicle to the wire harness on the MagneRide strut.

FIGURE 30A

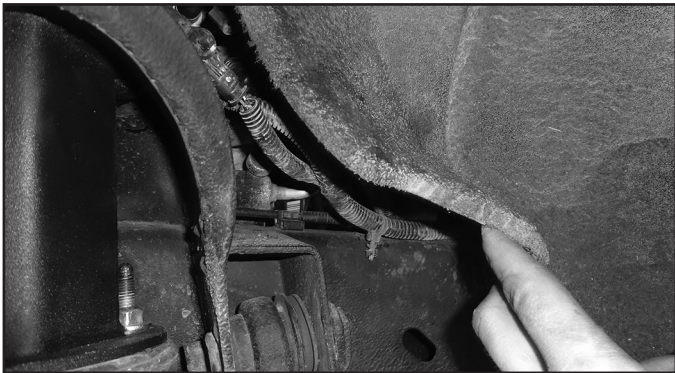
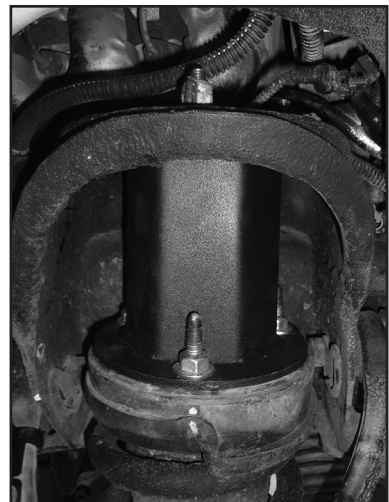



FIGURE 30B



52. Install the strut assembly to the appropriate frame mount with the original nuts. Leave hardware loose. Make sure there is enough slack on the MagneRide wire harness.

 **Tip** *Note: Be sure that the strut is oriented properly in the vehicle.*

53. Swing the lower control arm up to the strut and fasten it with the original mounting bolts. Torque lower and upper strut hardware to 40 ft-lbs.
54. Remove the hub bearing/rotor assembly and brake dust shield from the factory steering knuckles. Be sure to note which hub goes on which side of the vehicle. Save mounting bolts.
55. The brake dust shield needs to be trimmed. Measure in from the lower vertical edge (opposite the ABS sensor location) 1/2" and make a straight line to the edge shown in **Figure 31**. Cut the section off of the brake dust shield.

FIGURE 31

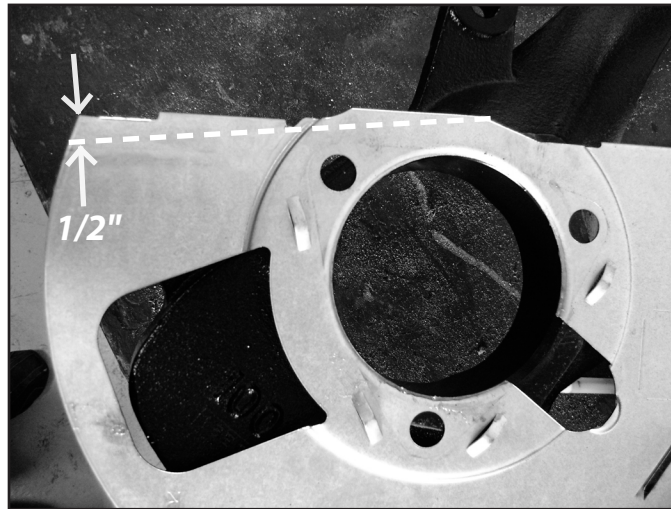

56. Install the modified dust shield and hub/rotor in the corresponding new knuckles. Fasten the hub/shield with the OE bolts. Apply Loctite to the bolt threads and torque to 133 ft-lbs. Be sure that the ABS line is run properly through the dust shield and out above the steering arm on the knuckle.
57. Install the assembled knuckle on the lower control arm.

Vehicles with cast steel control arms: *Use the original lower ball joint nut.*

Vehicles with aluminum / stamped steel control arms: *Use the provided lower ball joint spacer as shown in Figure 32 with the factory nut. Failure to do so will not allow the lower ball joint to fully seat.*

FIGURE 32 - STOCK ALUMINUM STEERING KNUCKLES ONLY



58. Attach the knuckle to the upper control arm with the original upper ball joint nut.



Tip *To make connecting the upper ball joint easier, loosen the upper control arm cam bolts at the frame and rotate the cams to shift the control arm outward. You can also lightly pry down on the arm off of the coil spring.*

59. Install the factory CV axle shaft into the hub and fasten with the original nut/washer and torque to 155 ft-lbs. Install dust cap.
60. Torque the upper ball joint nut to 37 ft-lbs and the lower ball joint nut to 74 ft-lbs.
61. Position the provided CV spacer between the CV shaft and the differential mounting flange (Fig. 33). Fasten the CV and spacer to the differential flange with 10mm x 70mm SHCS bolts. Use Loctite on the bolt threads and torque to 45 ft-lbs using a crossing pattern.



Tip *Hardware for the CV spacers is located in hardware pack 568.*

FIGURE 33

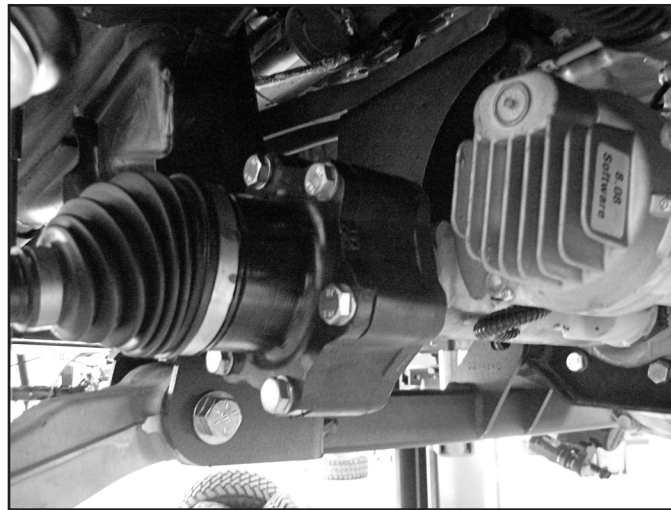

62. Remove the factory tie rod ends and install the new provided tie rod ends so the bend in the tie rod faces forward to provide clearance to the coil spring at full lock. Leave approximately 1/4" of threads showing on the steering link.
63. Remove the front brake line retaining clips and slide the brake line through the bracket. To avoid having to bleed the brakes, cut an opening in the factory brake line bracket so the bracket can be removed from the line. Take care not to nick the brake line. Disconnect the bracket from the frame. Save hardware.



Tip *If you are not comfortable with cutting the bracket, disconnect the rubber line from the hard line. The brake system will have to be bled upon completion.*

64. Attach the caliper to the new steering knuckle with the original mounting hardware. Torque bolts to 125 ft-lbs.
65. Carefully remove the metal retainer bracket from the factory rubber brake line. This can be done with two vice grips, pliers, or crescent wrenches.



Tip *It may be easier to remove the brake line from the bracket by removing it from the vehicle completely and holding the bracket in a bench vise. If the brake line is removed, the system will need to be bled.*

66. Align the tab in the provided brake line bracket to the upper control arm mount and attach the bracket using the original mounting hole and OE bolt (Fig. 35) Torque the brake line bracket to 20 ft-lbs.

FIGURE 34

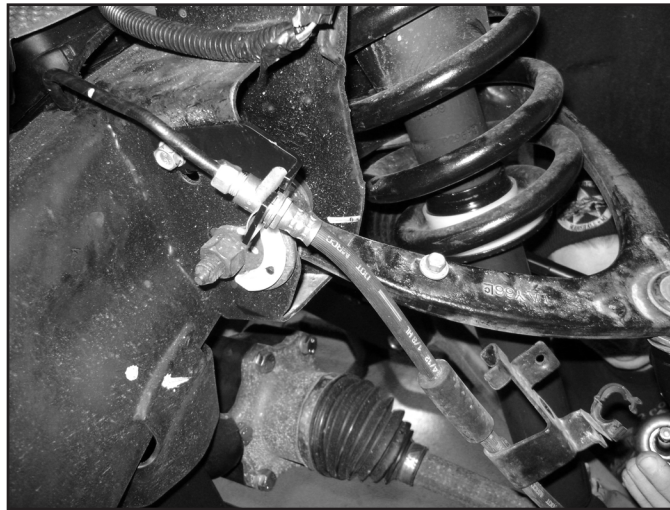

67. Carefully reform the brake hard line down so it meets the new bracket. Run the end of the rubber brake hose through the bracket and retain the brake line to the bracket with the original clip.
68. Attach the new bracket (02940 – Driver, 02941 – Pass.) to the upper control arm with the factory bolt. Apply Loctite to the bolt before tightening. Insert the MagneRide sensor through the hole in the bracket and attach using the provided 6mm lock nut. Attach the ABS line and brake line to the side of the bracket using the two provided wire clamps and 1/4" x 1" bolt, 1/4" washer, and 1/4" lock nut. (Fig. 35)



Tip Hardware for the MagneRide Sensor, ABS & brake line clamps for attaching to the brackets on the control arm is located in bolt pack 980.

FIGURE 35A

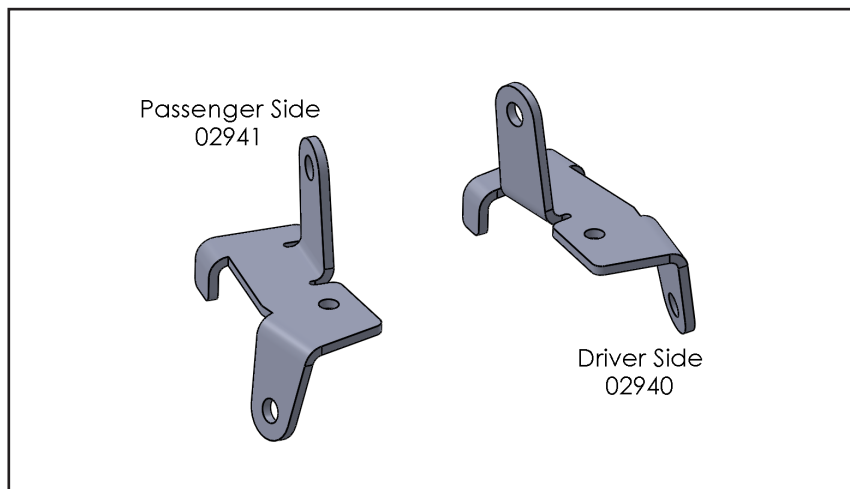

FIGURE 35B



69. Reconnect ABS line at the frame. Attach the ABS line to the steering knuckle with the provided wire clamps and $\frac{1}{4}$ " x $\frac{3}{4}$ " self tapping bolt and flat washer. Torque bolt to 15 ft-lbs. Use zip ties to retain the remaining section of the ABS line as needed to keep it away from rotating objects. (Fig. 36)



Tip Hardware for the brake line clamps for attaching to the knuckle is located in bolt pack 448.

FIGURE 36



70. Attach the front sway bar to the original mounts in the stock orientation in conjunction with the provided drop brackets (02166B - 6.5" kit, 02491 - 4.5" kit) and 10mm bolts/washers (10mm x 120mm - 6.5" kit, 10mm x 80mm - 4.5" kit). Use Loctite on the bolt threads and torque to 45 ft-lbs. (Fig. 37)



Tip Hardware for the sway bar drops is located in bolt pack 449 for 6.5" kit.

FIGURE 37

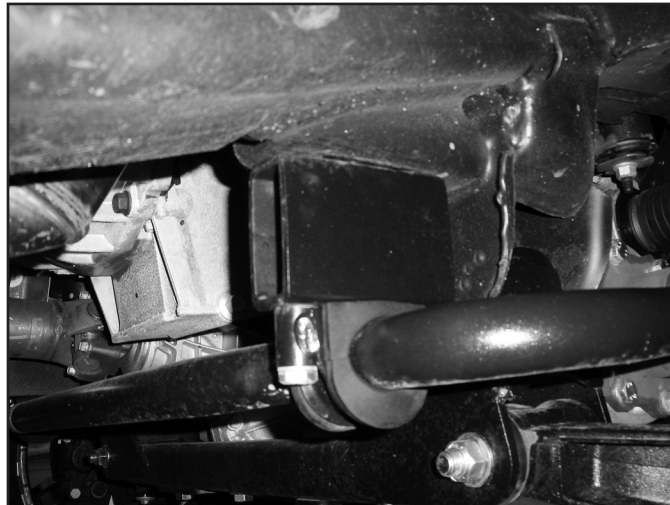

71. The new sway bar links will be built from a 5" sleeve, $\frac{3}{8}$ " x 9" bolt, bushings and cup washers. Attach these to the sway bar followed by the control arm with the bolt going from the top down. (Fig. 38) Tighten the sway bar link until the bushings begin to form to the control arm surface.

FIGURE 38



72. Connect the steering tie rod ends to the knuckles with the short provided nylock nuts. Ensure the nut has full thread engagement. Torque to 60 ft-lbs. Tighten the tie rod end jam nuts securely. They will be adjusted during alignment. Install the zerk fittings into the tie rod ends.

! Caution *Do not use the supplied nuts that come in the bag kit with the zerk fitting. Use the shorter supplied nuts that come in the knuckle box kit.*

73. Install the wheels/tires and lower the front of the vehicle to the ground. Torque lug nuts to 140 ft-lbs.
74. Bounce the front of the vehicle to settle the suspension. Torque the lower control arm mounting bolts to 150 ft-lbs. If the upper control arm cam bolts were loosened during the installation, center the cams and torque the bolts to 125 ft-lbs.
75. Check differential and CV shafts for clearance in all areas including those cut for clearance.
76. Check all hardware for proper torque.
77. If necessary, bleed the entire brake system. See service manual for proper brake system bleeding procedures.
78. Reconnect the battery cables to the battery.

REAR INSTALLATION

1. Block the front wheels. Safely raise the rear of the vehicle and support with jack stands just ahead of the front leaf spring frame mount.
2. Remove the wheels.
3. Support the rear axle with a floor jack.
4. Disconnect the rear brake line bracket from the top of the differential (Fig. 39). Save hardware.



Tip *The bracket uses a captive bolt, meaning that it is loosely pressed into the bracket hole.*

FIGURE 39

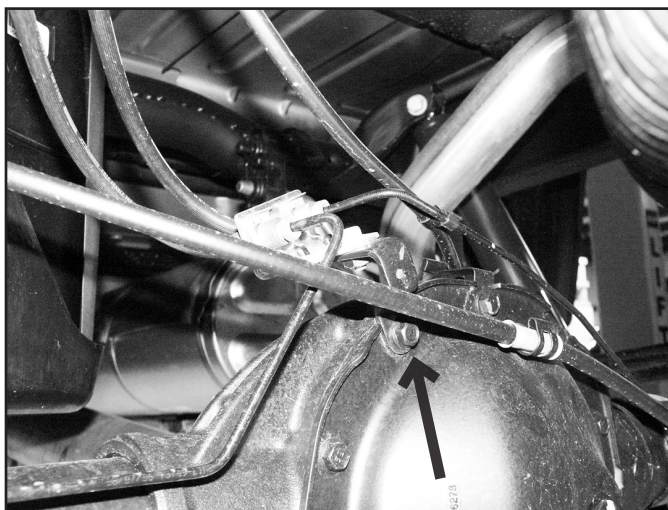

5. Remove the ABS lines from the retaining clip on the bottom of each frame rail. Also disconnect the ABS line connector from the top of the frame rail. (Fig. 40).

FIGURE 40



6. Remove the driver's side parking brake cable brackets from the driver's side frame rail. (Fig. 41A)
7. Support the center of the axle with a hydraulic jack. Disconnect the wire harness from the Rear MagneRide shock. Remove the clip holding the wire harness for the rear MagneRide shock to the frame. Remove the upper and lower shock bolts. Remove the shock from the vehicle. Save hardware. Note: The spare tire may need to be lowered to remove the driver side upper shock bolt. (Fig. 41 B & C)

FIGURE 41A

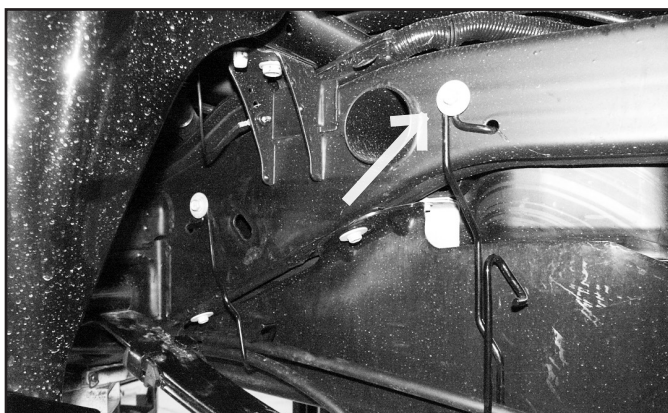
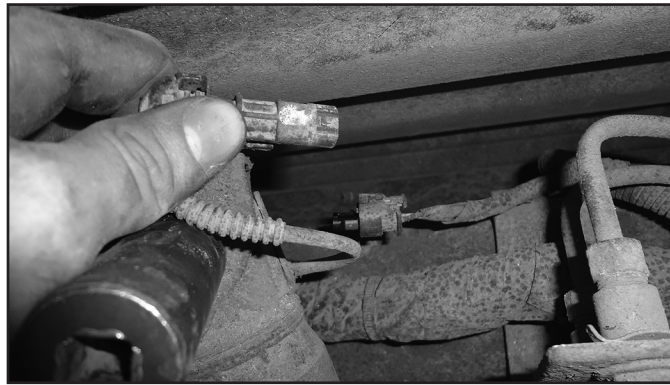

FIGURE 41B



FIGURE 41C



REAR LIFT BLOCK INSTALLATION

8. With the axle still well support remove the passenger's side u-bolts. The u-bolts will not be reused. Slowly lower the axle and remove the factory block from the axle. The factory block will not be reused.
9. Lower the axle just enough to install the new provided lift block between the axle and the spring. Position the block so the male pin side is forward when compared to the female or top of the block. This will assist in shifting the axle forward. Align the pin in the block with the hole in the axle and the hole in the block with the leaf spring pin. It may be necessary to loosen the driver's side u-bolts slightly to allow the axle to lower far enough to install the block. The rear sensor should be sandwiched between the lift block and the leaf spring, same as the stock configuration. The tab on the bottom of the rear sensor plate may need to be bent flat to work with the new rear lift block.
10. Using the support jack, raise the axle so that the axle, spring and block are all touching. Install the new provided u-bolts, nuts and washers allow with the factory u-bolt plate. (Fig. 42) Snug u-bolts but do not tighten.

FIGURE 42A



FIGURE 42B



FIGURE 42C



11. Repeat the installation on the driver's side of the vehicle. Pay special attention to all of the brake lines and wires. Do not allow them to get over-extended.
12. Remove the rear rubber bump stops from the frame. Access the bolt head up through the center of bump stop using a 10mm socket. Remove the bump stop and install the provided 3" diameter x 3" tall spacer between the bump stop and the frame mount with a 10mm x 110mm Allen head bolt (Loctite threads). Center the spacer on the lip of the factory bump stop cup and torque bolt to 35 ft-lbs. (Fig. 43)



Tip Hardware for the bump stop spacers is located in hardware pack #628.

FIGURE 43

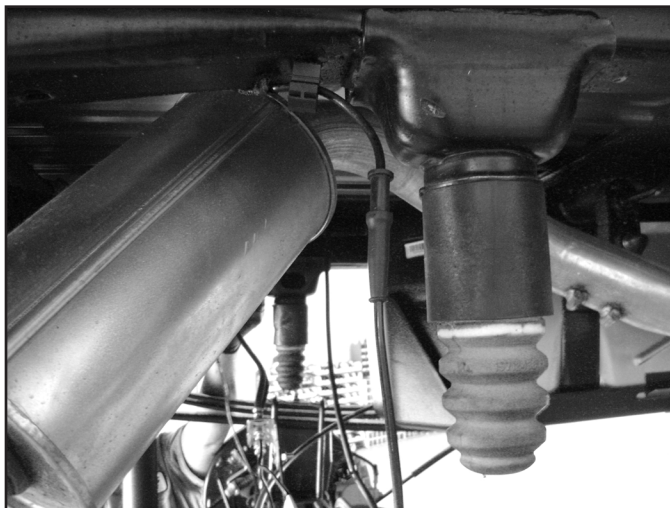

13. Loosely attach the upper shock relocation bracket to the upper mount with the stock hardware. Swing the bracket up until the wing contacts the support tube in the frame.

FIGURE 44



14. Mark the location of the hole in the upper shock relocation bracket on the support tube in the frame. Center punch the holes and drill out to 1/2". The shock relocation brackets may need to be removed while drilling holes in the frame.



Tip *Note: Help may be required to hold the exhaust out of the way while the hole is drilled on the passenger side.*

FIGURE 45



15. If the upper shock relocation bracket was removed, reattach the bracket to the frame with the stock upper bolt. Apply Loctite and insert a 1/2" bolt and washer through the hole in the bracket and through the hole drilled in the previous step in the frame. Insert the nut tab inside the tube on the frame and tighten the 1/2" bolt to the nut tab. Torque the upper shock bolt to 65 ft-lbs and the 1/2" hardware to 60 ft-lbs.



Tip Hardware for the upper shock relocation bracket is located in bolt pack 979.

FIGURE 46

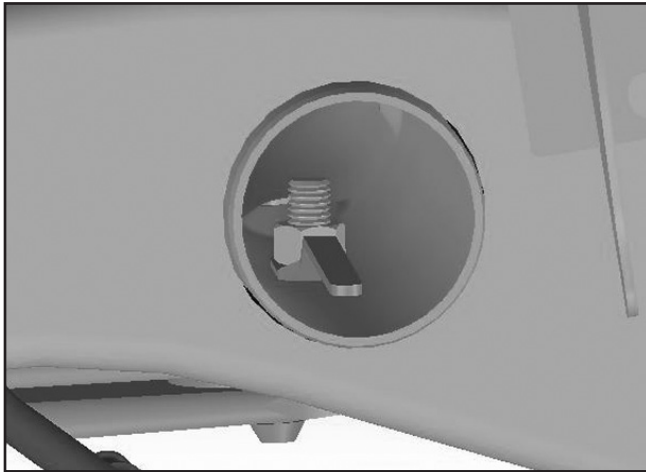
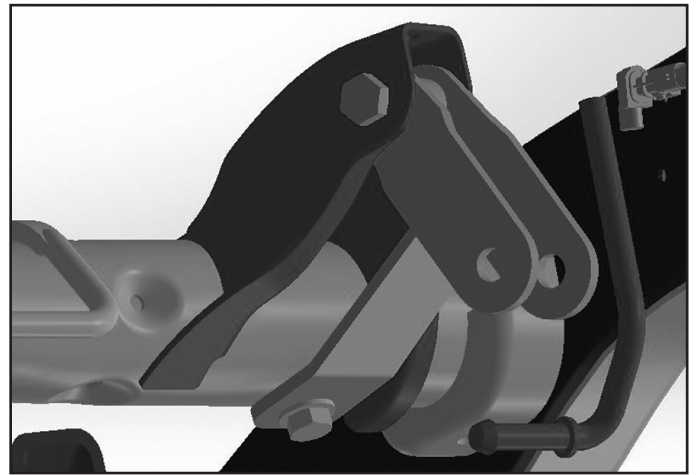

FIGURE 47



16. Install the MagneRide rear shock into the new upper shock mount bracket with the provided 9/16" x 3" bolt, 9/16" SAE washers, and 9/16" prevailing torque nut. Attach the shock to the lower shock mount with the factory hardware. Reconnect the wire harness to the MagneRide rear shock, the wire harness may need to be unclipped from the frame to gain additional slack. Since the MagneRide shocks utilize a rubber bushings, leave shock hardware loose until the weight of the vehicle is on the shock.

FIGURE 48



17. Install the provided straight 3" brake line bracket to the top of the differential using factory mounting hole and bolt which must be removed from the factory brake line bracket. Attach the factory brake line bracket to the relocation bracket with a 5/16" x 1" bolt, nut and washers. Torque the factory and 5/16" bolt to 20 ft-lbs. (Fig. 44)



Tip Hardware for the brake line bracket is located in hardware pack #628. Be sure the ABS wire will not contact the exhaust.

FIGURE 49

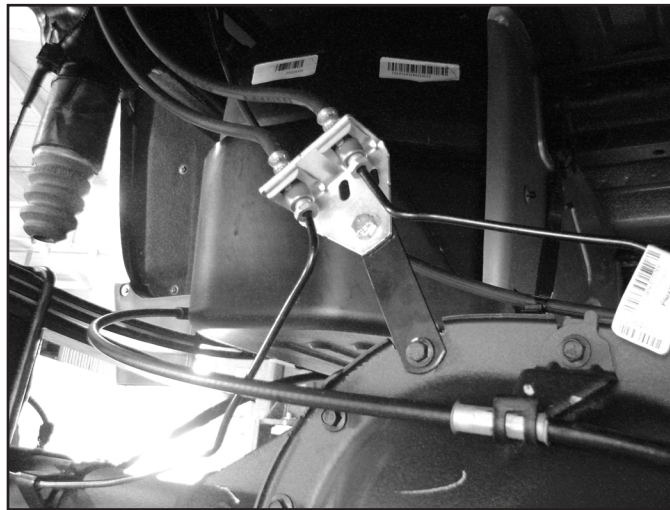

18. Reconnect the ABS lines to the plastic retaining clip at the bottom of each frame rail. The connector will not be reattached to the top of the frame. Reroute the lines as necessary to gain proper slack.
19. Reconnect the parking brake cable brackets to the driver's side frame rail with the original hardware. The driver's side cable will have to be removed from the rear bracket to gain appropriate slack. Torque bolts to 20 ft-lbs.
20. Install wheels and tires. Torque lug nuts to 140 ft-lbs. Lower vehicle.
21. Bounce the rear of the vehicle to settle the suspension. Torque leaf spring u-bolts to 100-120 ft-lbs. Torque the shock hardware as follows: 9/16" hardware to 90 ft-lbs and factory lower shock bolts to 65 ft-lbs.

POST INSTALLATION

22. Double check all fasteners for proper torque.
23. Check all moving parts for clearance.
24. Complete a full radius turning check to ensure that no interference occurs.
25. Align headlights
26. Double check the brake lines for adequate slack at full wheel travel.
27. Complete a vehicle alignment.
28. Check all fasteners after 500 miles.



WE WANT TO SEE YOUR RIDE!

Grab photos of your BDS-equipped truck in action and send them in for a chance to be featured. Send it in to our Bad Ass Rides customer gallery at bds-suspension.com/bar and post them on the BDS Fan Page on Facebook at facebook.com/BDSSuspensions. Don't forget about your BDS swag! BDS offers t-shirts, hoodies, decals and more available on the BDS website or through your local BDS distributor.

TIME TO HAVE SOME FUN

Thank you for choosing BDS Suspension.

For questions, technical support and warranty issues relating to this BDS Suspension product, please contact your distributor/installer before contacting BDS Suspension directly.