

INSTALLATION GUIDE



Part#: 023652



HARDCORE LIMITED LIFETIME WARRANTY

4", 5" & 6" Suspension System

Ford F150 4WD (4" & 6" ONLY) | 2021-2026

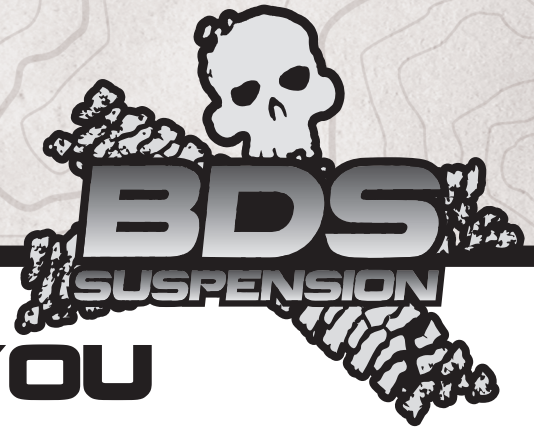
Ford F150 Tremor 4WD (4" & 5" ONLY) | 2021-2026

Rev. 011426

491 W. Garfield Ave., Coldwater, MI 49036 • Phone: 517-279-2135

E-mail: tech-bds@ridefox.com

Read And Understand All Instructions And Warnings Prior To Installation Of System And Operation Of Vehicle.



THANK YOU

Your truck is about to be fitted with the best suspension system on the market today. That means you will be driving the baddest looking truck in the neighborhood, and you'll have the warranty to ensure that it stays that way for years to come. Thank you for choosing BDS Suspension!

BEFORE YOU START

BDS Suspension Co. recommends this system be installed by a professional technician. In addition to these instructions, professional knowledge of disassembly/ reassembly procedures and post installation checks must be known.

FOR YOUR SAFETY

Certain BDS Suspension products are intended to improve off-road performance. Modifying your vehicle for off-road use may result in the vehicle handling differently than a factory equipped vehicle. Extreme care must be used to prevent loss of control or vehicle rollover. Failure to drive your modified vehicle safely may result in serious injury or death. BDS Suspension Co. does not recommend the combined use of suspension lifts, body lifts, or other lifting devices. You should never operate your modified vehicle under the influence of alcohol or drugs. Always drive your modified vehicle at reduced speeds to ensure your ability to control your vehicle under all driving conditions. Always wear your seat belt.

BEFORE INSTALLATION

- Special literature required: OE Service Manual for model/year of vehicle. Refer to manual for proper disassembly/reassembly procedures of OE and related components.
- Adhere to recommendations when replacement fasteners, retainers and keepers are called out in the OE manual.
- Larger rim and tire combinations may increase leverage on suspension, steering, and related components. When selecting combinations larger than OE, consider the additional stress you could be inducing on the OE and related components.
- Post suspension system vehicles may experience drive line vibrations. Angles may require tuning, slider on shaft may require replacement, shafts may need to be lengthened or trued, and U-joints may need to be replaced.
- Secure and properly block vehicle prior to installation of BDS Suspension components. Always wear safety glasses when using power tools.
- If installation is to be performed without a hoist, BDS Suspension Co. recommends rear alterations first.
- Due to payload options and initial ride height variances, the amount of lift is a base figure. Final ride height dimensions may vary in accordance to original vehicle attitude. Always measure the attitude prior to beginning installation.

BEFORE YOU DRIVE

Check all fasteners for proper torque. Check to ensure for adequate clearance between all rotating, mobile, fixed, and heated members. Verify clearance between exhaust and brake lines, fuel lines, fuel tank, floor boards and wiring harness. Check steering gear for clearance. Test and inspect brake system.

Perform steering sweep to ensure front brake hoses have adequate slack and do not contact any rotating, mobile or heated members. Inspect rear



Visit 560plus.com for more information.

TRACTION CONTROL

In an effort to reduce the risk of rollover crashes the National Highway Traffic Safety Administration (NHTSA) established the Federal Motor Vehicle Safety Standard (FMVSS) No. 126 requiring all new passenger vehicles under 10,000 lbs GVWR include an electronic stability control (ESC) system as standard equipment. Effective August 2012 this law requires aftermarket products to be compliant with these same standards.



TIRES AND WHEELS

FITMENT GUIDE

5" Tremor Lift & 6" Lift:

35x12.50 on 18x9 or 20x9 w/ 5" backspacing
37x12.50 on 20x9 with 5.5" backspacing*

4" Lift:

33x12.50 on 18x9 or 20x9 w/ 5-5.5" backspacing
35x12.50 on 18x9 or 20x9 w/ 5" backspacing*
35x12.50 on 20x9 with 5.5" backspacing*

*Trimming is required

18" Wheel see troubleshooting notes



brake hoses at full extension for adequate slack. Failure to perform hose check/ replacement may result in component failure. Longer replacement hoses, if needed can be purchased from a local parts supplier.

Perform head light check and adjustment.

Re-torque all fasteners after 500 miles. Always inspect fasteners and components during routine servicing.

CONTENTS OF YOUR KIT

BDS023670 / BDS023671 - Knuckle Box Kit

Part #	Qty	Description
03991	1	Knuckle - Driver (BDS023670)
03992	1	Knuckle - Passenger (BDS023671)

BDS023414 (4" only) BDS023501 (5" only) BDS023654 (6" only) - Strut Spacer Box Kit

Part #	Qty	Description
02427	2	4" Strut spacer (BDS023414, BDS023501)
02725	2	6" Strut Spacer (BDS023654)
02082	2	Strut Preload Spacer (BDS023501)
897	1	Bolt Pack
	6	7/16"-14 Nylock Nut
	12	3/8" USS Flat Washer
	6	10mm - 1.50 Prevailing Torque Nut

BDS013538 - 5" Rear Block Kit

Part #	Qty	Description
02085	2	5" Rear Lift Block
02086	2	Lower Spring Plate
02087B	2	Upper Spring Plate
963181212QB	4	9/16 x 3-1/8 x 12-1/2 Square U-bolt
05025	1	Brake Line Relocation Bracket
120400FCP	2	1/2 x 4 Pin w/Nut
895	1	Bolt Pack
	1	5/16"-18 x 1" Bolt
	2	5/16" SAE Washer
	1	5/16"-18 Prevailing Torque Nut
	2	1/2"-20 x 3-1/2" Bolt - SHCS
	2	1/2"-20 Non-locking Nut
	8	9/16"-18 High Nut
	8	9/16" SAE Washer

BDS013437 - 3-1/4" Rear Block Kit

Part #	Qty	Description
03467	2	3-1/4" Rear Lift Block
3296	2	Bump Stop Extension
963181200SB	4	9/16 x 3-1/8 x 12 Radius Square U-bolt
05025	1	Brake Line Relocation Bracket
896	1	Bolt Pack
	1	5/16"-18 x 1" Bolt
	2	5/16" SAE Washer
	1	5/16"-18 Prevailing Torque Nut
	8	9/16"-18 High Nut
	8	9/16" SAE Washer
	2	10mm-1.25 x 80mm Bolt
	2	10mm Flat Washer

BDS023652 - Front Box Kit 1 of 2

Part #	Qty	Description
02779	1	Front BDS Cross Member
03983	2	Sway Bar Drop
05032	1	Differential Skid Plate
05022	1	Brake Line Bracket - Driver
05023	1	Brake Line Bracket - Passenger
02001	8	Cam Washer
02002	4	Cam Bolt
342701	1	Thread Locker
400408-10	1	10" Vent Hose
05033	1	1/4" Drive Shaft Spacer
15700143	4	Cable Tie "Oval Fir Tree"
099000	4	Cable Tie
02802	2	BDS Badge (Sway Bar Drop)
995	1	Bolt Pack - Rivets
	4	1/8" x 0.251-0.312 18-8 Stainless Steel Blind Rivet
828	1	Bolt Packs - Driveshaft Spacer
	6	10mm-1.50 x 75mm SHCS Bolt

BDS023653 - Front Box Kit 2 of 2

Part #	Qty	Description
05030	1	Rear Cross Member
05026	1	Differential Drop Bracket - Driver
05027	1	Differential Support Bracket - Driver
05028	1	Differential Drop Bracket - Passenger
05029	1	Differential Support Bracket - Passenger
894	1	Bolt Pack
	3	9/16"-12 x 4" Bolt
	4	9/16"-12 x 1-1/4" Bolt
	14	9/16" SAE Washer
	7	9/16"-12 Prevailing Torque Nut
	4	7/16"-14 x 1-1/4" Bolt
	8	7/16" SAE Washer
	4	7/16"-14 Prevailing Torque Nut
	2	18mm-2.50 x 150mm Bolt
	4	3/4" SAE Washer
	6	18mm-2.50 Prevailing Torque Nut
	2	8mm-1.25 x 18mm Bolt
	2	5/16" SAE Washer
	4	1/2"-13 x 1-1/4" Bolt
	4	1/2" SAE Washer

BDS013436 - 4" Rear Block Kit		
<i>Part #</i>	<i>Qty</i>	<i>Description</i>
02429	1	4" Rear Lift Block
02430	1	4" Rear Lift Block
963181200SB	4	9/16 x 3-1/8 x 12 Radius Square U-bolt
05025	1	Brake Line Bracket
896	1	Bolt Pack
	1	5/16"-18 x 1" Bolt
	2	5/16" SAE Washer
	1	5/16"-18 Prevailing Torque Nut
	8	9/16"-18 High Nut
	8	9/16" SAE Washer
	2	10mm-1.25 x 80mm Bolt (Extra Hardware)
	2	10mm Flat Washer (Extra Hardware)

BDS023645 - 6" Lift, 5" Rear CCD Box Kit		
<i>Part #</i>	<i>Qty</i>	<i>Description</i>
05303	2	Rear Shock Relocation Bracket - Outer
05304	2	Rear Shock Relocation Bracket - Inner
05305	1	Front Sensor Relocation - Driver
05306	1	Front Sensor Relocation - Passenger
941	1	Bolt Pack
	2	12mm-1.75 x 80mm Bolt
	2	12mm-1.75 Prevailing Torque Nut
	4	12mm Washer
354		Bolt Pack
	2	3/8"-16 x 1-1/4" Bolt
	4	3/8" SAE Washer
	2	3/8"-16 Prevailing Torque Nut

BDS013208 - 2" Rear Block Kit		
<i>Part #</i>	<i>Qty</i>	<i>Description</i>
2FB-D	2	2" Rear Lift Block
3296	2	2" Rear Bump Stop Spacer
963181200SB	4	9/16 x 3-1/8 x 12 Radius Square U-bolt
05025	1	Brake Line Bracket
896	1	Bolt Pack
	1	5/16"-18 x 1" Bolt
	2	5/16" SAE Washer
	1	5/16"-18 Prevailing Torque Nut
	8	9/16"-18 High Nut
	8	9/16" SAE Washer
	2	10mm-1.25 x 80mm Bolt
	2	10mm Flat Washer

IMPORTANT INFORMATION FOR YOUR VEHICLE

1. Some trucks with a 2 piece drive shaft may have a recall from Ford regarding the rear drive shaft. (Safety Recall 21S25) Due to the recall procedure, BDS recommends to have this performed prior to installing the lift."
2. 18" wheels with 5-5.5" backspacing should be test fit prior to mounting the tire to ensure proper clearance to the steering knuckle/tie rod. 5.5" backspacing is highly recommended for tire to frame crash bar clearance.
3. 18" or larger diameter wheels required. Stock 17" and 18" wheels cannot be re-installed. Stock 20" wheels can be used with up to a 305/60R20 tire.
4. Models with 2-piece rear driveshaft WILL require carrier bearing shim kit 122405 (not included w/ kit)
5. Block kits replace factory 1-1/4" block. Stock block will not be reinstalled.
6. Crash bars may require modification based on wheel and tire choice. It is the end users responsibility to ensure modifications are non-detrimental to vehicle safety.
7. Does not fit diesel models.
8. 6" kit will not fit Tremor models.
9. 4" and 5" kits on tremor must use 3-14" rear block kit only. Other block heights cause driveline vibrations.
10. Tremor models with the 4" kit can use the factory rear block, this configuration provides a slight tail low stance. The provided 3-1/4" rear block provides about 1" of rake on the 4" kit.
11. Requires frame bracket modification
12. 5" rear block kit will net a more tail high stance, 4" rear block kit will net a more level stance on 6" front kits.
13. 3-1/4" rear block kit will net a more tail high stance, 2" rear block kit will net a more level stance on 4" front kits.

PRE INSTALLATION

IMPORTANT

It is required that ride height measurements be taken before and after installation. Measure from the **WHEEL AXLE CENTER** up to the **FENDER LIP** of the wheel opening. Do this for all 4 wheels. Record measurements below.**

BEFORE

Left Front _____ *Right Front* _____

Left Rear _____ *Right Rear* _____

AFTER

Left Front _____ *Right Front* _____

Left Rear _____ *Right Rear* _____



****These ride heights will be required if you have any ride height concerns after installation. Please be prepared to provide these to Technical Support.**

INSTALLATION INSTRUCTIONS

SPECIAL TOOLS

FRONT INSTALLATION

1. Park the vehicle on a clean, flat surface and block the rear wheels for safety. Measure and record and record ride heights of all 4 wheels as described above.
2. Raise the front of the vehicle and support with jack stands at each frame rail behind the lower control arms.
3. Remove the front wheels.

Basic hand tools / sockets / wrenches
1-1/16" socket / wrench(18mm Bolts / Nuts)
Reciprocating saw or equivalent
Torque wrench
Special Service Tool: 204-592 Separator
Tie Rod End Separator
Strut Compressor (5" Tremor kit only)

4. Remove the factory skid plates / splash guards (Fig 1A / B / C).

FIGURE 1A

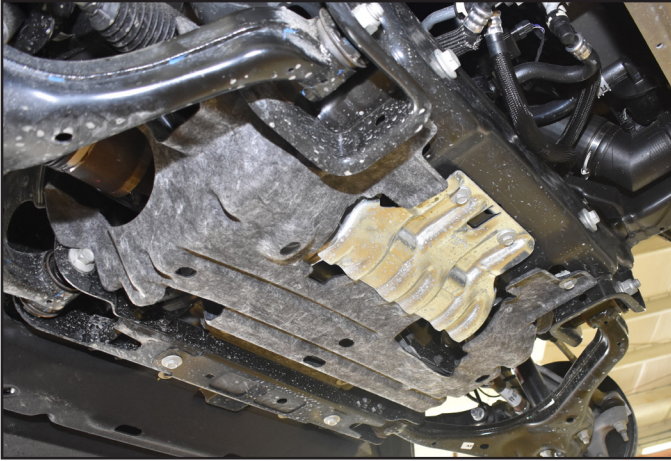


FIGURE 1B

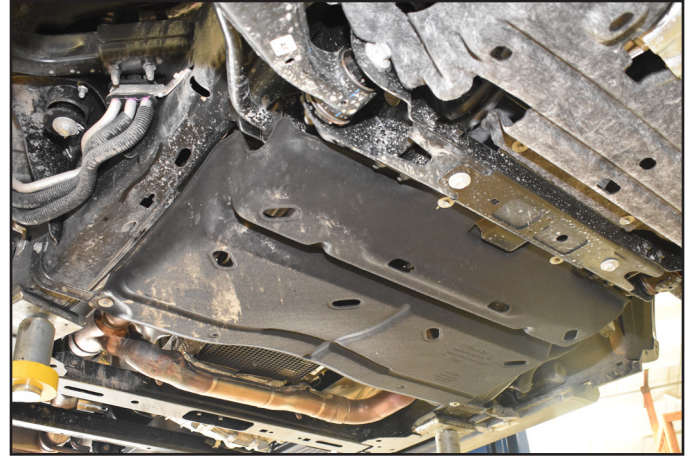


FIGURE 1C



! Caution EPAS (Electronic Power Assist Steering), disconnect the power steering control module connector to avoid arching of the contacts in the internal power relay from a hammer blow or impact wrench.

5. Remove the brake caliper anchor bracket bolts and remove the caliper from the knuckle (Fig 2). Hang the caliper out of the way. Do not let the caliper hang by the brake hoses.

FIGURE 2



6. Remove the brake rotor and set aside.
7. Remove the dust shield from the knuckle and set aside.
8. Disconnect the ABS and 4wd actuator hub assembly lines from the retaining clips (Fig 3A). Remove the ABS sensor from the hub (Fig 3B). Save Bolt. The 4wd actuator hub assembly can remained attached to the inner fender and allowed to hang.

Note: Be careful not to damage the 4wd actuator hub assembly if it is kept attached to the vehicle and hanging,

FIGURE 3A

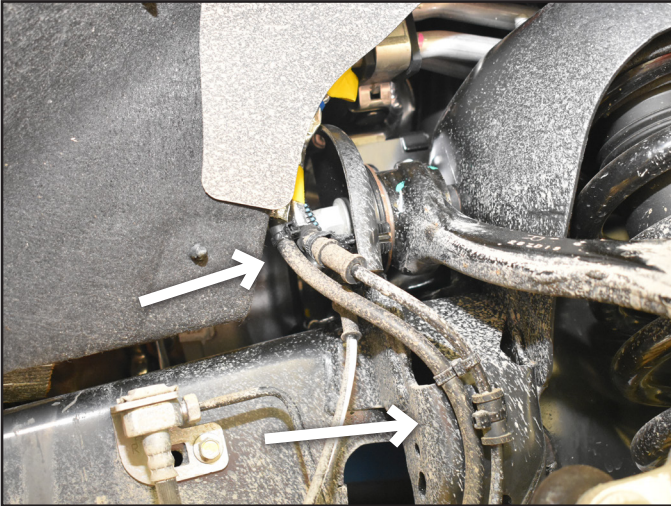
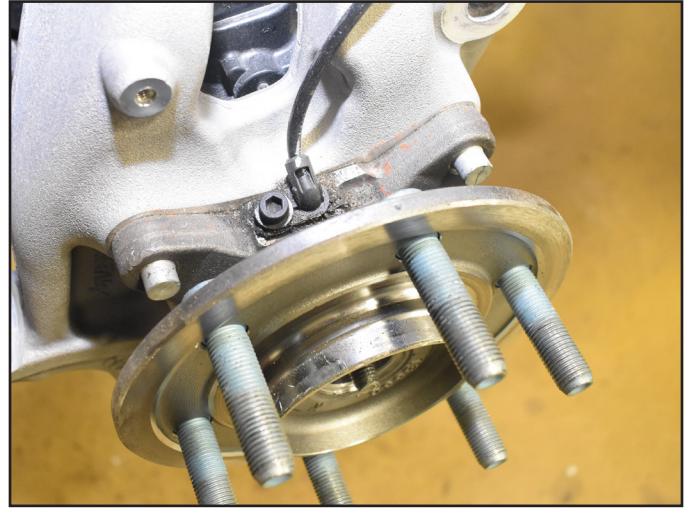


FIGURE 3B

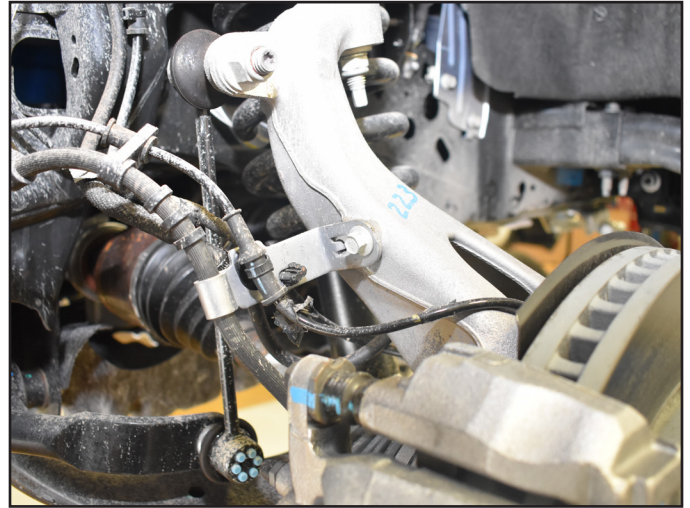


9. Remove the clip attaching the brake line to the brake line bracket, save clip for later installation. Disconnect the brake line bracket from the frame rail (Fig 4A). Save bolts. Slide the bracket up the brake line and carefully cut a slit in the factory brake line bracket so that it can be removed from the truck. Disconnect the brake line bracket from the steering knuckle (Fig 4B). Discard bolts.

FIGURE 4A



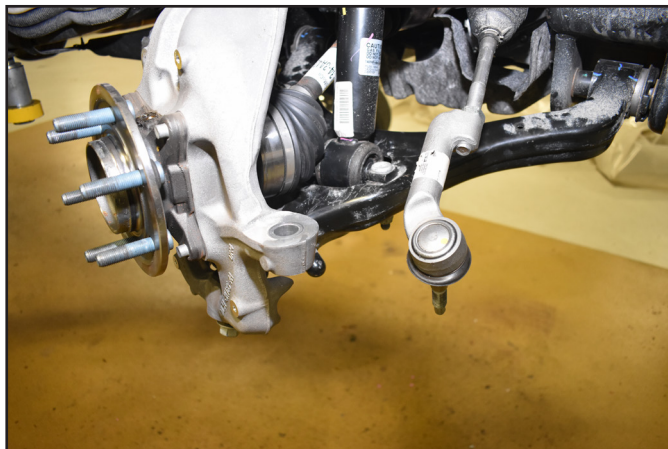
FIGURE 4B



10. Disconnect the tie rod ends from the steering knuckles. Remove and save the nuts. Avoid hitting the aluminum steering knuckle, use appropriate tool to remove tie rod end from steering knuckle. Take care not to strike the tie rod end, or damage the threads (Fig 5).

Note: Use a tie rod end separator to release the taper from the steering knuckle.

FIGURE 5



11. Disconnect the sway bar links from the steering knuckle (Fig 6A). Retain hardware. The sway bar links do not need to be removed from the sway bar.
12. Remove the four sway bar mounting nuts and remove the sway bar from the vehicle (Fig 6B). Retain hardware

! Caution Do not use power tools to remove the stabilizer bar link nut. Damage to the stabilizer bar link ball joint or boot may occur

FIGURE 6A

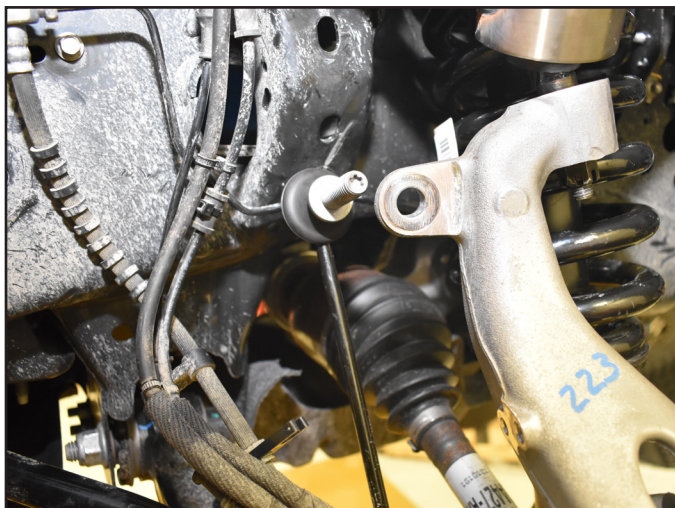


FIGURE 6B



13. Carefully remove the hub dust cap to expose the axle shaft nut (Fig 7A / B). Remove the nut. Retain the cap and nut, they will be reinstalled later.

FIGURE 7A

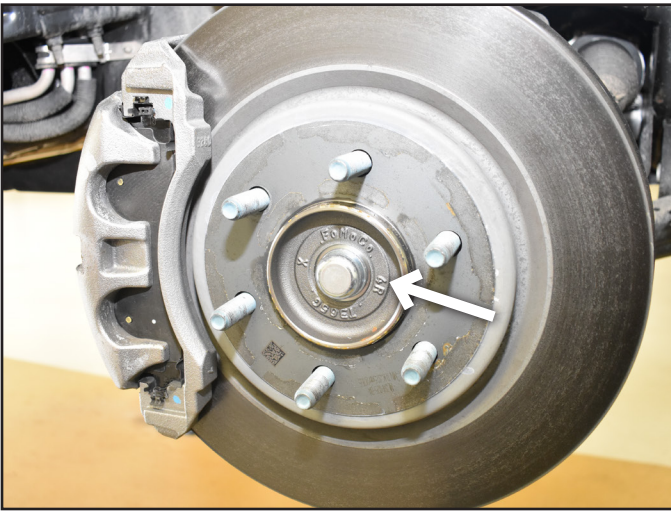
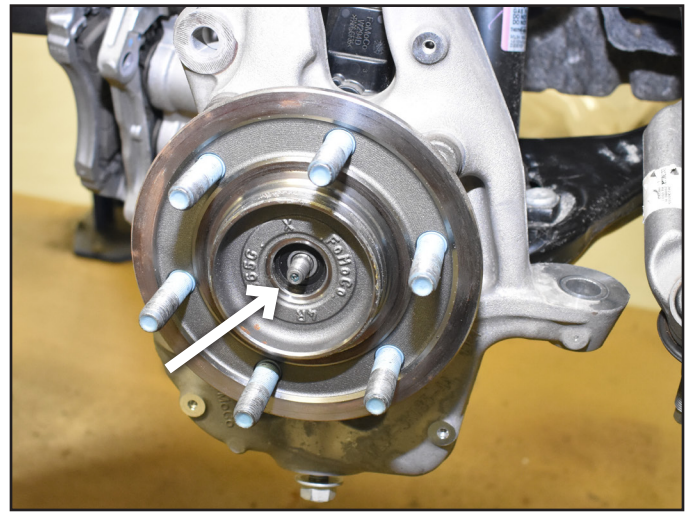


FIGURE 7B



14. Loosen but do not remove the three strut assembly mounting nuts at the frame (Fig 8). Do not loosen the middle strut nut.

FIGURE 8



15. Remove the 4 bolts attaching the 4wd actuator hub assembly to the steering knuckle. Figure 9 is shown with the CV shaft pulled out for clarity. Note that some models starting in 2022 will not have the 4wd actuator hub assembly, skip this step if not equipped.

Note: If allowing the 4wd actuator hub assembly to hang make sure it is secured out of the way so it does not get damaged. If removing from the vehicles make sure to mark the locations it was clipped in to the fender for later installation.

FIGURE 9



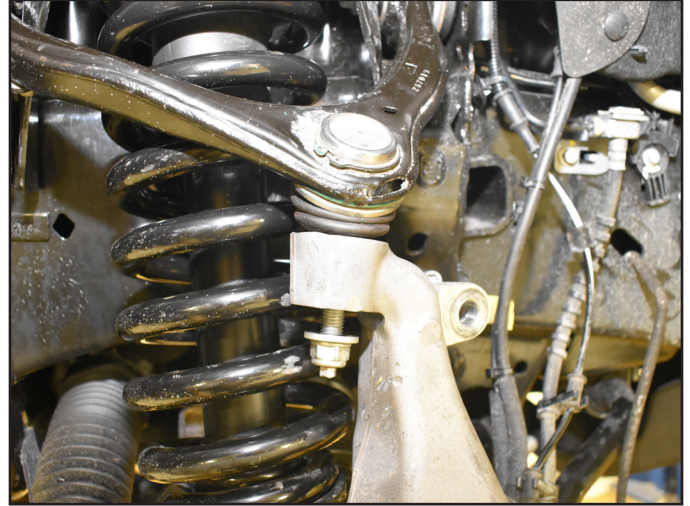
16. Loosen but do not remove the upper and lower ball joint nuts (Fig 10A / B). Unseat the upper and lower ball joints from the knuckle, refrain from hitting the aluminum steering knuckle, use appropriate tool to separate ball joints, avoid damaging the threads.

Note: Use Special Service Tool: 204-592 Separator to release the taper from the steering knuckle.

FIGURE 10A



FIGURE 10B



17. Remove the upper ball joint and the strut-to-lower control arm hardware. Swing the knuckle/lower control arm down to remove the CV shaft from the hub. Retain ball joint nut and strut bolts.
18. Remove the lower ball joint nut and remove the knuckle from the vehicle. Retain hardware. Secure the 4wd hub actuator so that it is not damaged during the installation. If desired, the actuator can be removed from the vehicle by unclipping the wire harness and breather line from the inner fender / truck.
19. Mark the struts to distinguish between driver's and passenger's.
20. **CCD MODELS ONLY:** Disconnect the sensor on the strut assembly
21. Remove the three strut assembly mounting nuts at the frame and remove the strut assembly from the vehicle.
22. Remove the lower control arm mounting bolts and remove the lower control arm from the vehicle (Fig 11). Retain hardware.

FIGURE 11



23. Take a wire brush and remove the material from the threads of the four bolts that attach the OE rear cross member. Remove the bolts and cross member from the vehicle. Discard the cross member and hardware (Fig 12).
24. Remove the drive shaft mounting bolts and disconnect the drive shaft from the differential (Fig 13). Allow the drive shaft to rest out of the way. Discard factory drive shaft mounting bolts.

FIGURE 12

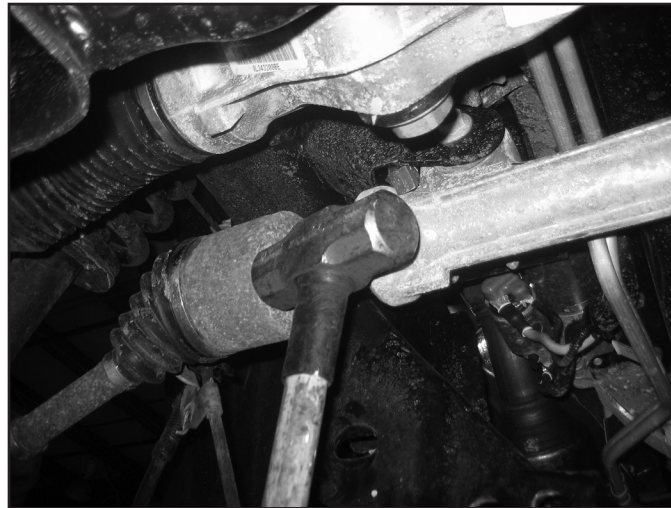


FIGURE 13



25. **Optional:** Remove the passenger's side CV only. Strike the shaft with a hammer to dislodge it from the splines. This will make handling the differential much easier (Fig 14).

FIGURE 14



26. Support the front differential with an appropriate jack. Loosen all of the hardware and slide the differential all the way to the passenger's side. Orientate the joint at the steering rack so there is the most possible clearance to remove the front driver's side bolt. Remove this bolt first. Disconnect the differential breather hose from the differential housing. Remove the rear driver's side and one passenger's side differential mounting bolts (Fig 15A/ B) and remove the differential from the vehicle.

FIGURE 15A

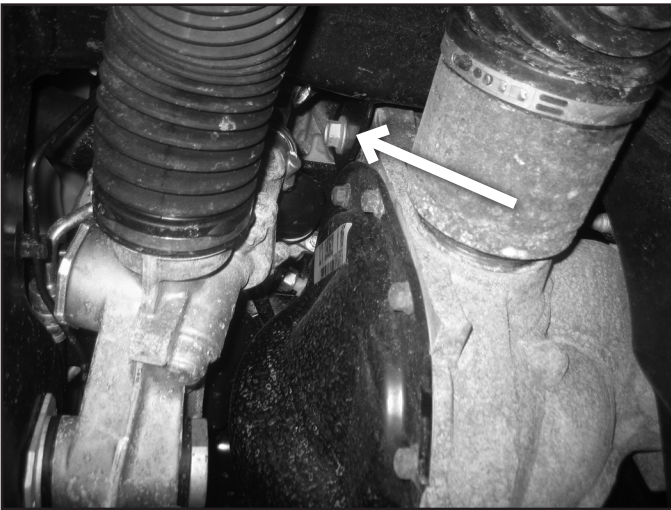
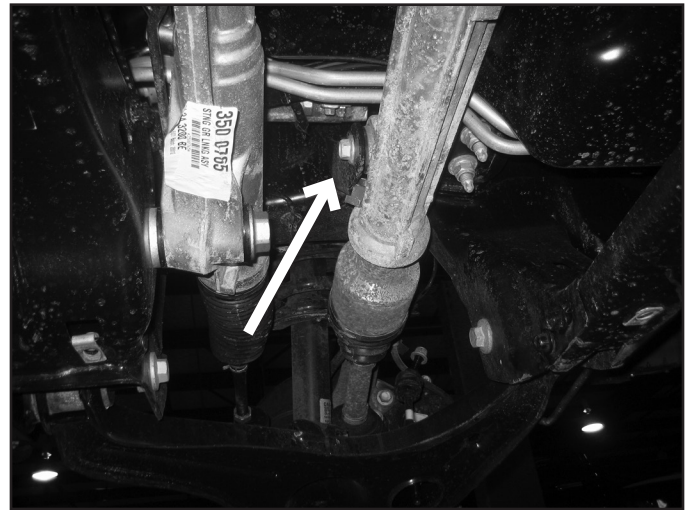


FIGURE 15B



27. The driver's side rear lower control arm frame pocket must be modified to provide clearance for the differential in its relocated position. On the front side measure from the inside edge of the slot 9/16" (Fig 16A / B). Make a vertical cut line at the mark.

FIGURE 16A

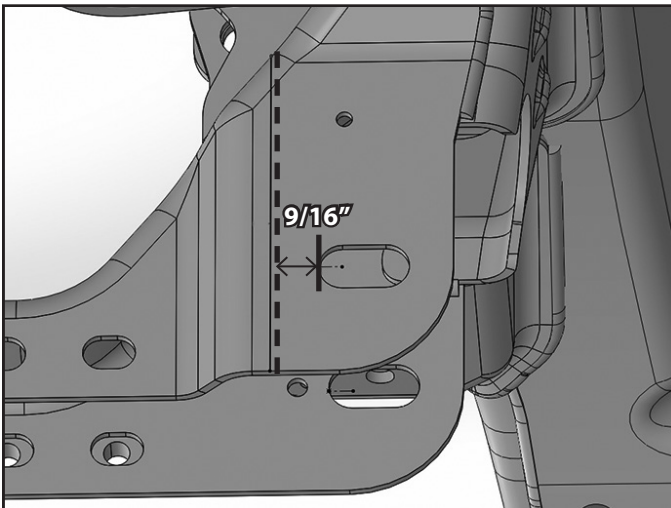


FIGURE 16B



28. On the back side measure from the inside edge of the slot 9/16" and make / mark a vertical cut (Fig 17A).
29. Connect the front cut line straight to the back face. This will require trimming on the factory differential mount tab (Fig 17B / C).

FIGURE 17A

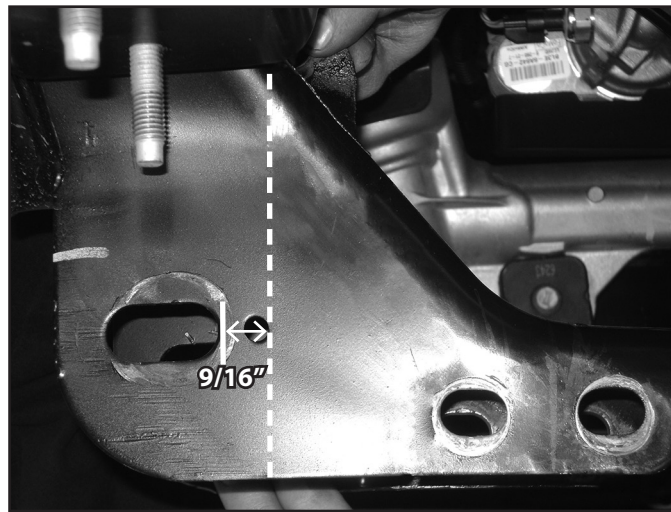


FIGURE 17B

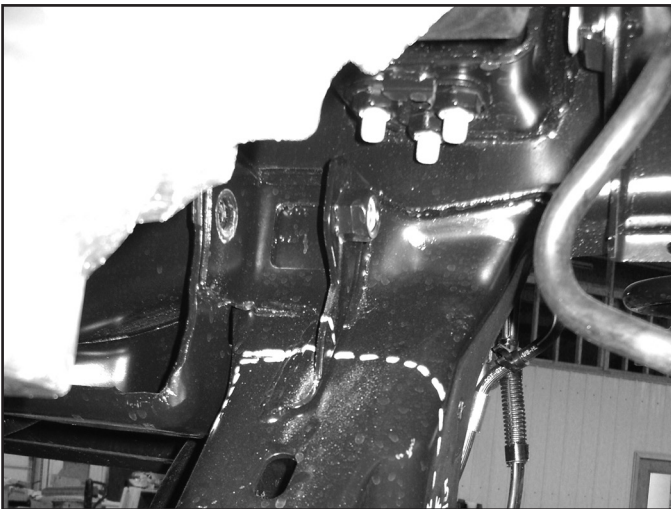


FIGURE 17C



30. The rear bushing will need to be modified to provide clearance to the frame pocket. Using a clamp or ball joint press to compress the edge of the outer end bushing such that the bushing edge is folded over until the outer edge of the bushing is just starting to touch the aluminum housing of the front differential (Figure 18A / B). This will NOT affect the performance of the differential bushing, but will provide clearance to the frame in extreme conditions.

FIGURE 18A



FIGURE 18B



31. Attach the differential relocation brackets (05026-Driver, 05028-Passenger) to the differential with 9/16" hardware, do not tighten at this time. The passenger side bracket will have a cutout "window" in the bracket for clearance to the steering rack (Fig 19A). Run the hardware from front to rear. Both brackets will be installed with the 2 holes towards the rear of the vehicle. Raise the differential with the brackets attached into the vehicle by aligning the differential mounts in the two front drop brackets attach to the frame with OE hardware (Fig 19B).

FIGURE 19A

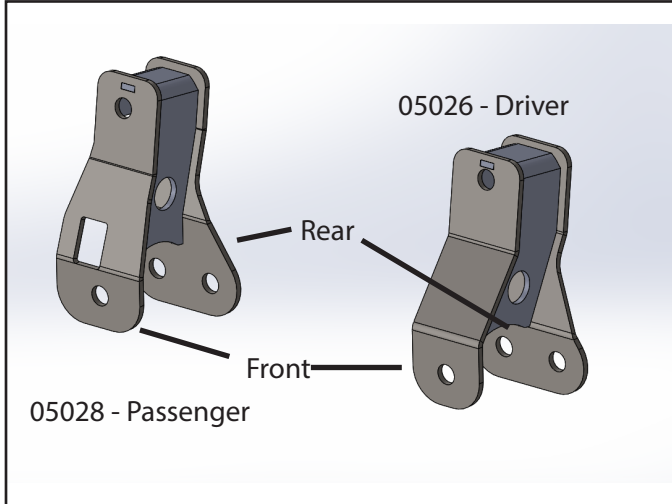


FIGURE 19B



32. Install the new rear cross member (05030) in the rear lower control arm frame pockets. Attach the rear cross member with the sway bar drop brackets (03983) with new 18mm bolts and washers. Run bolts from rear to front (Fig 20A). Leave hardware loose. Ensure the cutout made in the previous step is adequate to clear the differential mounting bolt (Fig 20A). Do not tighten hardware at this time.

Note: Check clearance between the frame and rear cross member on the passenger side. The factory frame cross member mount may need to be cleared out due to factory frame variance.

Note: If the hardware is difficult to install it might be necessary to open up the factory cam slot due to frame mounting width variances

33. Fasten the differential to the rear cross member (Fig 20B) with a 9/16" bolt, washers, and nut (Bolt Pack #894). Run the bolt from rear to front. Leave hardware loose.

FIGURE 20A

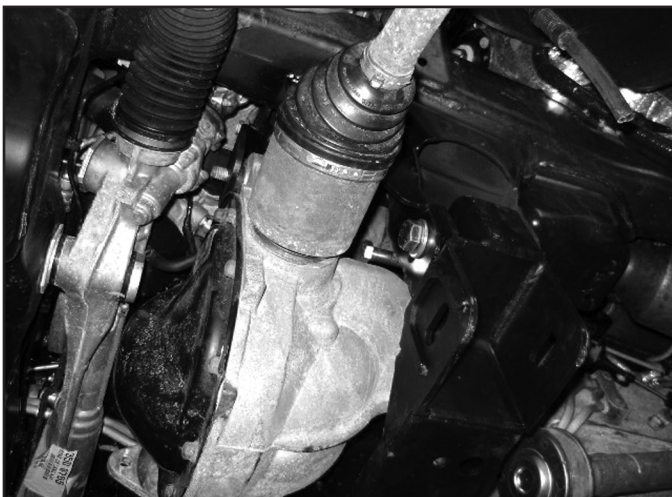
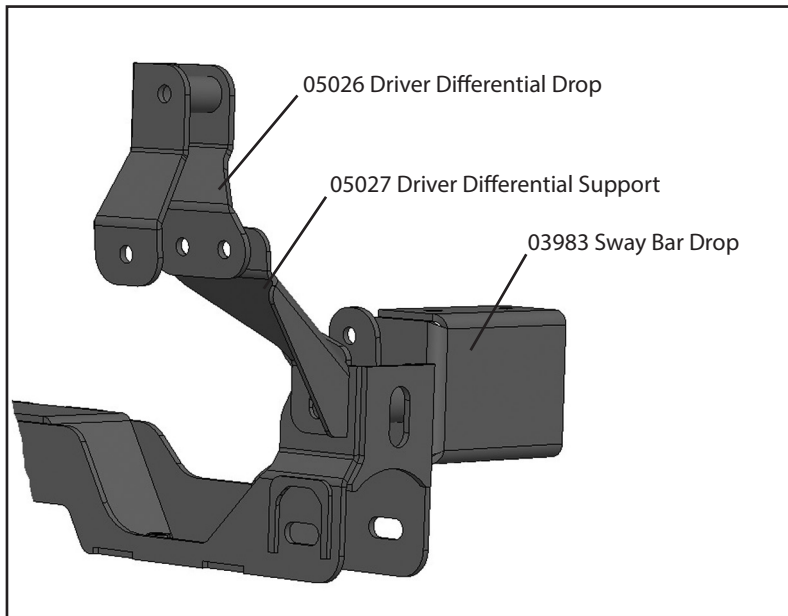


FIGURE 20B



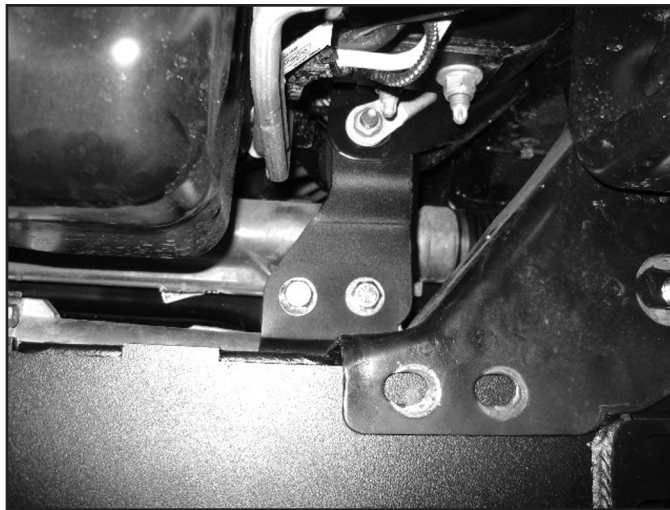
34. Fasten the support bracket (05027) to the rear of the differential drop bracket. Fasten with the driver's side rear cross member hardware. Attach the hardware at the differential bracket from the front to rear. Leave all hardware loose at this time (Fig 21).

FIGURE 21



35. Install the offset differential support bracket (05029) to the backside of the passenger's side differential bracket using the hardware that was just installed and a 9/16" x 1-1/4" bolt, washers, and nut. Attach the differential support bracket to the rear cross member with two 9/16" x 1-1/4" bolt, washers, and nuts. Leave hardware loose (Fig 22).

FIGURE 22



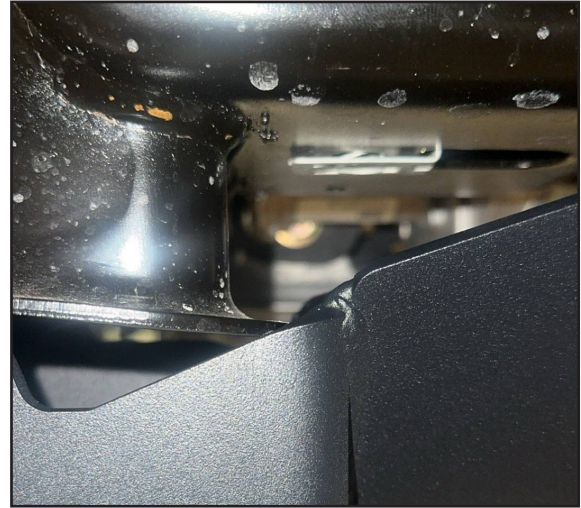
36. Torque all of the differential mounting hardware to 95 ft-lbs.
37. Attach the differential breather tube. Remove the differential breather elbow from the plastic line and replace it with the provided hose and attach it to the differential.

38. Install the front cross member (02779) in the front lower control arm pockets and fasten with the OE lower control arm hardware running hardware from front to rear. It will be necessary to bend the OE frame ear up in order to gain clearance. (Fig. 23A,B) Bend the frame ear up until a minimum of 1/8" clearance is present between the crossmember and the OE frame ear. Test and adjust fitment as needed until the crossmember fits into place. Leave hardware loose.

FIGURE 23A

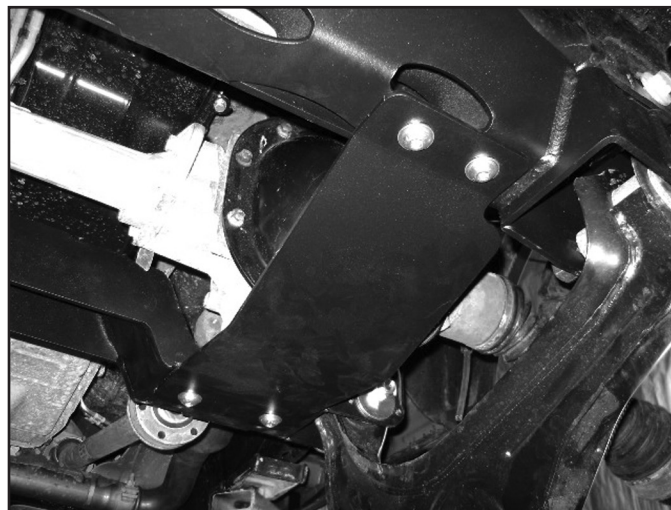


FIGURE 23B



39. Install the lower control arms in the new cross members and fasten with the provided 18mm cam bolts, cam washers and 18mm nuts. Run the front bolts from front to rear and leave loose. Run the rear bolts from rear to front. The main body of the cam will be 'up' in the cam slot
40. Install the provided differential skid plate (05032) to the front and rear cross members with 1/2" x 1-1/4" bolts and 1/2" washers (Bolt Pack #894) into the weld nuts in the cross members (Fig 24). Leave hardware loose.

FIGURE 24



41. Attach the sway bar drop brackets to the frame using the factory nuts and nut tabs. Snug but do not tighten at this time.



Tip

Use a ratchet extension through the lower slots to access the hardware (Fig 25A / B)

FIGURE 25A

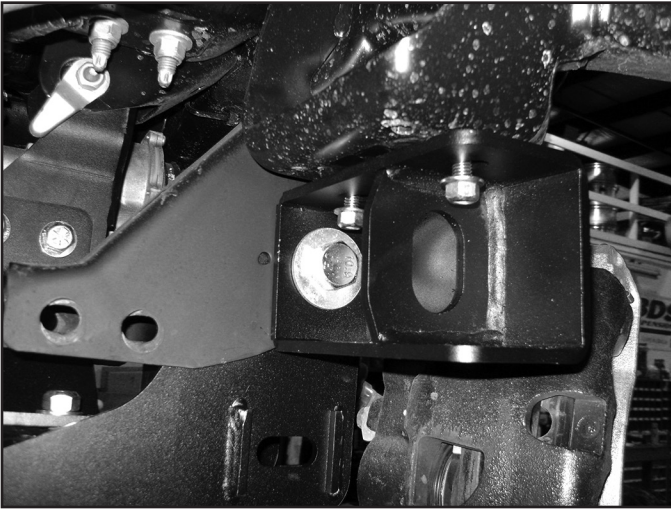


FIGURE 25B



42. With the lower control arms installed torque the four cross member mounting bolts to 250 ft-lbs. Ensure that the front cross member is centered in the vehicle. Torque the differential skid plate bolts to 65 ft-lbs. Tighten sway bar drop hardware to 46 ft-lbs.
43. Reinstall the passengers side CV (If removed).

4" & 6" PERFORMANCE SERIES 2.0 SNAP RING COILOVERS FOLLOW INSTRUCTIONS INCLUDED WITH COILOVERS SKIP TO STEP 46

STRUT INSTALLATION (4" & 6" KITS ONLY)

44. The same strut spacer is used on both sides. Place the 02725 (6") or 02427 (4") strut spacer on each strut and attach with new 10mm nuts (Bolt Pack #897). Tighten to 52 ft-lbs.
45. Install the strut and spacer assembly into the vehicle. Attach to upper mount with new 7/16" nuts and washers (Bolt Pack #897). Leave hardware loose at this time. (Fig 26A).

FIGURE 26A



STRUT INSTALLATION | 5" TREMOR KIT ONLY

46. Place alignment marks on the upper strut mount, isolator, spring, strut body and lower coil seat for reference to maintain the orientation of all the parts when re-assembling the strut. (Fig 27A / B / C)

FIGURE 27A

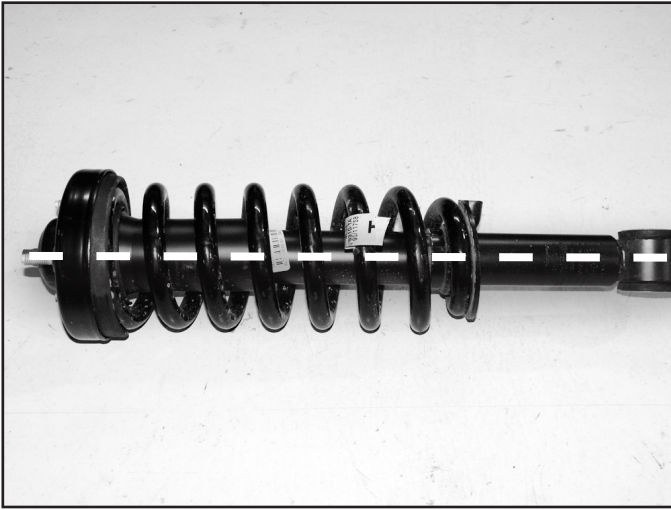


FIGURE 27B

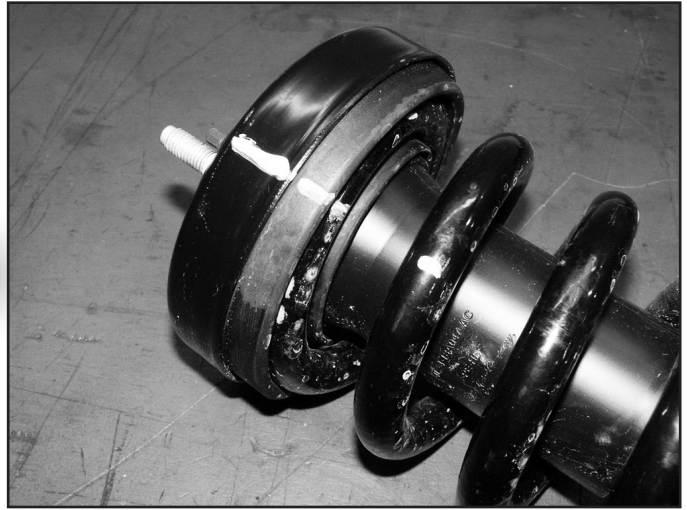


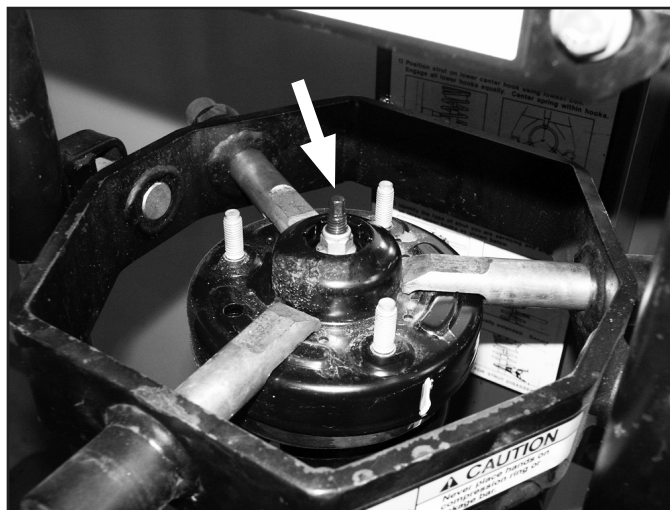
FIGURE 27C



CAUTION: Coil spring is under extreme pressure. Improper removal/installation of coil spring could result in serious injury or death. Use only a high quality spring compressor and carefully read and follow the manufacturer's instructions.

47. Using an appropriate strut compressor, compress the coil spring and remove the upper strut nut (Fig 27). Remove the strut and upper strut mount/isolator from the coil spring.

FIGURE 28



48. Working on the upper strut mount, remove the rubber isolator (FIG 28A) from the strut mount and install the provided preload ring (FIG 28B). Reinstall the upper isolator and line up the alignment marks from step 47.

FIGURE 29A



FIGURE 29B



49. Reassemble the strut making sure to line up all the alignment marks. Fasten the strut rod with the original nut. Torque the strut nut to 41 ft-lbs.
50. The same strut top spacer is used on both sides. Place the 02427 (4") strut spacer on each modified strut and attach with new 10mm nuts (Bolt Pack #897). Tighten to 52 ft-lbs.
51. Install the strut and spacer assembly into the vehicle. Attach to upper mount with new 7/16" nuts and washers (Bolt Pack #897). Leave hardware loose at this time (Fig. 30)

FIGURE 30



COILOVER INSTALLATION

52. If installing Fox Coilovers, install the coilover the same as the factory strut using the provided hardware with the coilover. Install the reservoir mount to the top of the strut bucket on the frame. Attach the reservoir to the reservoir mount using the provided clamps. (Fig. 31)

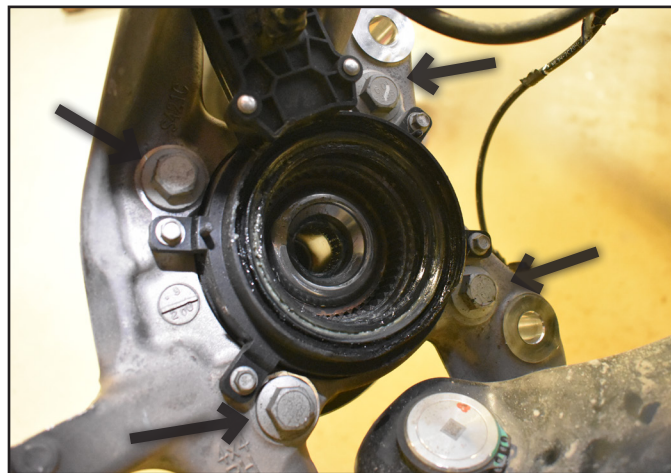
FIGURE 31



ALL KITS

53. Remove the four hub bolts from the knuckle and remove the hub from the knuckle (Fig 32). Inspect mounting surface of the hub assembly and clean any dirt or corrosion off as necessary.

FIGURE 32

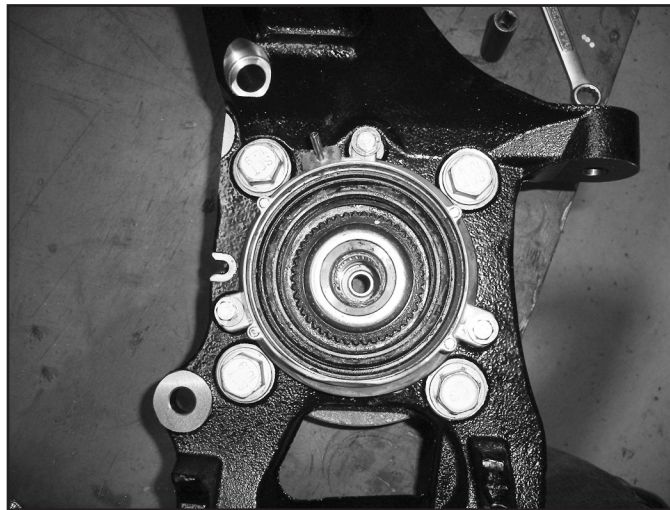


54. Install the hub into the corresponding new BDS knuckle (Driver- 03991, Passenger- 03992) and fasten with the OE bolts. Make sure the ABS wire is located at the 'top' of the hub. Use thread locker on the bolt threads and torque to 129 ft-lbs.
55. If not previously removed; remove the (4) 6mm bolts mounting the 4wd actuator hub assembly to the inside of the OE knuckle (Fig 33). Transfer the 4wd actuator hub assembly over to the new knuckle. The assembly can install with the 4wd actuator hub assembly towards the "top" of the knuckle. Attach with the OE bolts, tighten bolts to 106 in-lbs. Note that some models starting in 2022 will not have the 4wd actuator hub assembly, skip this step if not equipped.

Note: If the 4wd actuator hub assembly was not removed from the vehicle reinstall the assembly when the knuckle is installed into the vehicle. Make sure the CV shaft is inserted through the assembly and be careful not to damage the 4wd hub actuator assembly.

Note: If the hardware is difficult to install it might be necessary to open up the factory cam slot due to frame mounting width variances

FIGURE 33



56. Install the new knuckle assembly on the lower control arm ball joint and loosely fasten with the original nut. Install the CV shaft in the hub, swing the whole assembly up and attach the lower control arm to the strut with the original hardware (Fox coil-overs use included hardware). Leave all hardware loose.
57. Attach the upper control arm to the knuckle with the original nut.
58. Torque the upper ball joint to 46 ft-lbs
59. Torque the lower ball joint to 98 ft-lbs.
60. Torque the upper strut nuts to 52 ft-lbs.
61. Torque the lower strut mount bolts to 66 ft-lbs. For Fox Coilovers, remove each of the bolts individually and apply thread locker and reinstall,
62. Fasten the CV shaft to the hub with the original nut. Make sure the splines are engaged properly in the 4wd actuator hub assembly section of the hub. The hub should have a very minor amount of rotational play with the CV shaft if installed properly, torque to 30 ft-lbs. Reinstall the dust cap.

Note: Trucks that do NOT have the IWE / 4wd actuator hub assembly, that DO have the large diameter axle nut, torque the nut to 221 ft-lbs.
63. Install tie rod from top-down. Torque to 66 ft-lbs.
64. Install the brake line relocation brackets (05022 - Driver, 05023 - Passenger) at the frame with the OE bolt. Torque to 15 ft-lbs. Attach the brake line to the new bracket using the clip removed previously. (Fig 34)

FIGURE 34



65. Install the dust shield with the factory 6mm bolts, tighten bolts to 133 in-lbs.
66. Install the brake rotor and caliper to the knuckle with OE bolts using thread locker. Torque to 184 ft-lbs.

67. Install the sway bar to the new sway bar drop brackets with 7/16" x 1-1/4" bolts, nuts and 7/16" SAE washers (Bolt Pack #894). Attach the sway bar end links to the steering knuckles with the original hardware. Torque the 7/16" hardware to 46 ft-lbs. Torque sway bar link nut to 111 ft-lbs.

! Caution Do not use power tools to attach the stabilizer bar link nut. Damage to the stabilizer bar link ball joint or boot may occur

68. Attach the ABS line to the connector at the inner fender and the 4wd actuator hub assembly line to the hub if disconnected. Route the lines similar to the factory setup down to the side of the knuckle. Attach the brake line with a new 8mm x 18mm bolt with 5/16" washer to the side of the knuckle (Bolt Pack #894), the brake line locating tab will go into the unthreaded hole Torque 8mm bolt to 169 in-lbs. (Fig 35A / B). Use the provided "oval fir tree" cable ties as needed along with regular cable ties to hold the ABS / 4wd actuator hub assembly lines out of the way of the tire and sway bar.

FIGURE 35A

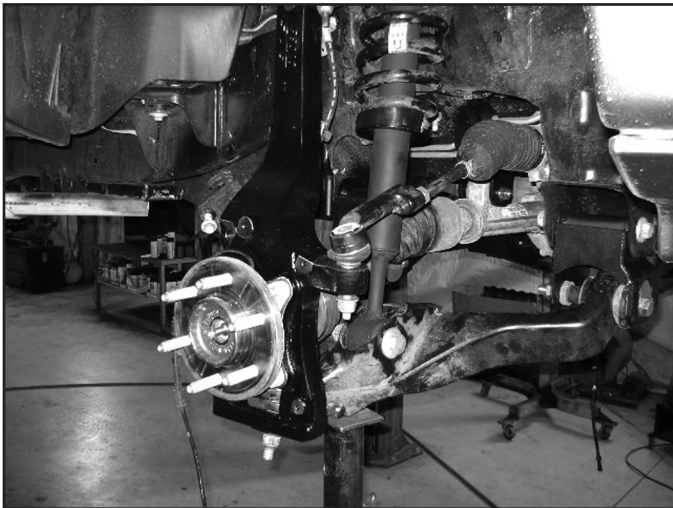
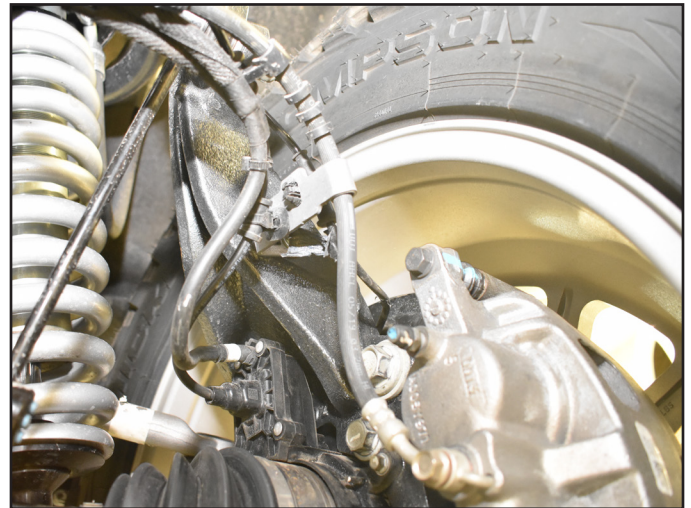


FIGURE 35B



CCD MODELS ONLY, SKIP AHEAD TO STEP 72 IF NOT EQUIPPED WITH CCD

69. Reconnect the CCD sensor to both strut assemblies. The line will need to be rerouted up the strut and to the frame. Cut any factory cable ties from the sensor wire and remove any plastic retaining clips to reroute the wire. (Fig. 36) Use the provided "oval fir tree" cable ties as needed along with regular cable ties to hold the CCD sensor lines out of the way of the tie rod boot and coil spring. (Fig 37A / B, pass side shown) (Fig 37C / D, driver side shown).

FIGURE 36



FIGURE 37A



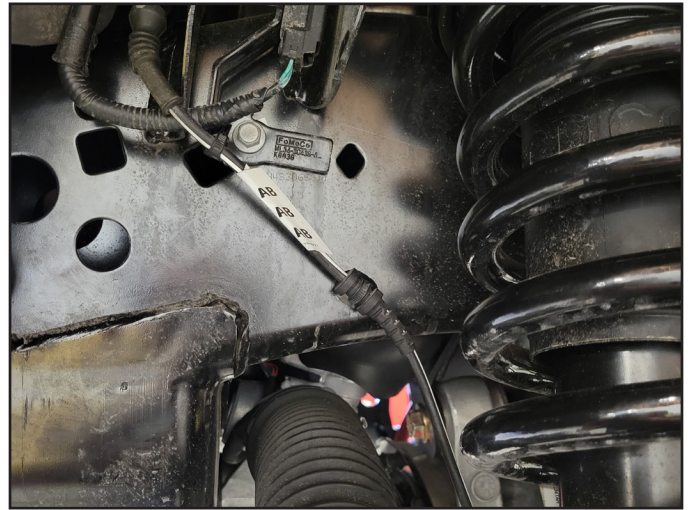
FIGURE 37B



FIGURE 37C



FIGURE 37D



70. Remove the ride height sensor bracket from the upper control arm and disconnect the nut holding the sensor linkage to the bracket. (Fig 38.) Retain hardware.

FIGURE 38



71. Install the supplied sensor relocation brackets (05305 Driver Side, 05306 Passenger Side) to the upper control arms with factory bolts. Torque to 177 in-lbs. Reconnect sensor linkage to the relocation bracket with the factory nut. (Fig 39. Driver Side Shown)

FIGURE 39



72. Install the supplied 1/4" drive shaft spacer and reattach front drive shaft to differential with new hardware and using the factory washer plates and thread locker (Bolt Pack #828). Torque bolts to 41 ft-lbs (Fig 40).

FIGURE 40



73. The "BDS" badge can now be riveted on to the sway bar drops using the provided 1/8" rivets (Bolt Pack #995) (Fig 41). Any residue on the badge can be cleaned up using alcohol or brake cleaner before install. With the badge not installed it can be painted to what ever color you desire, or left raw as a stainless steel badge

FIGURE 41



74. Install the wheels and lower the vehicle to the ground.
75. Bounce the front of the vehicle to settle the suspension. Center the lower control arm cams and torque to 250 ft-lbs. Adjust the toe before driving it to an alignment shop.

76. Cycle steering, the crash bars that protrude from the frame may create clearance issues with the front tires. Modifications may be required for clearance.
77. Check all hardware for proper torque.

REAR INSTALLATION

78. Block the front wheels and raise the rear of the vehicle. Place jack stands under the frame rails ahead of the spring hangers.
79. Remove the wheels.
80. Disconnect the rear brake line from the frame. Save bolt for later installation.
81. Support the rear axle with a hydraulic jack.
82. Remove the OE shocks. Retain mounting hardware. *If installing on a CCD equipped truck, only remove bottom shock hardware .*
83. Remove rear ride height sensor at the leaf spring side if applicable. (Fig 42)

FIGURE 42



Note: Perform the rear installation on one side at a time.

84. Remove the axle u-bolts on one side of the axle.
85. Lower the axle and remove the OE lift block (if installed), it will not be reused.

5" REAR BLOCK KIT; 4", 3-1/4", OR 2" REAR BLOCK KITS SKIP AHEAD

86. Using C-clamps, clamp the leaf spring pack together on each side of the center pins. Remove the center pins and discard.
87. Place the new bottom plate (02086) on the bottom of the leaf pack and secure with new center pin (120400FSCP) in the 'forward' hole and flat head allen bolt through the 'rear' hole (Bolt Pack #895). Install new u-bolt retaining plate on top (02087B), it will be offset 'forward'. Tighten to 35 ft-lbs (Fig 43A / B / C).

FIGURE 43A

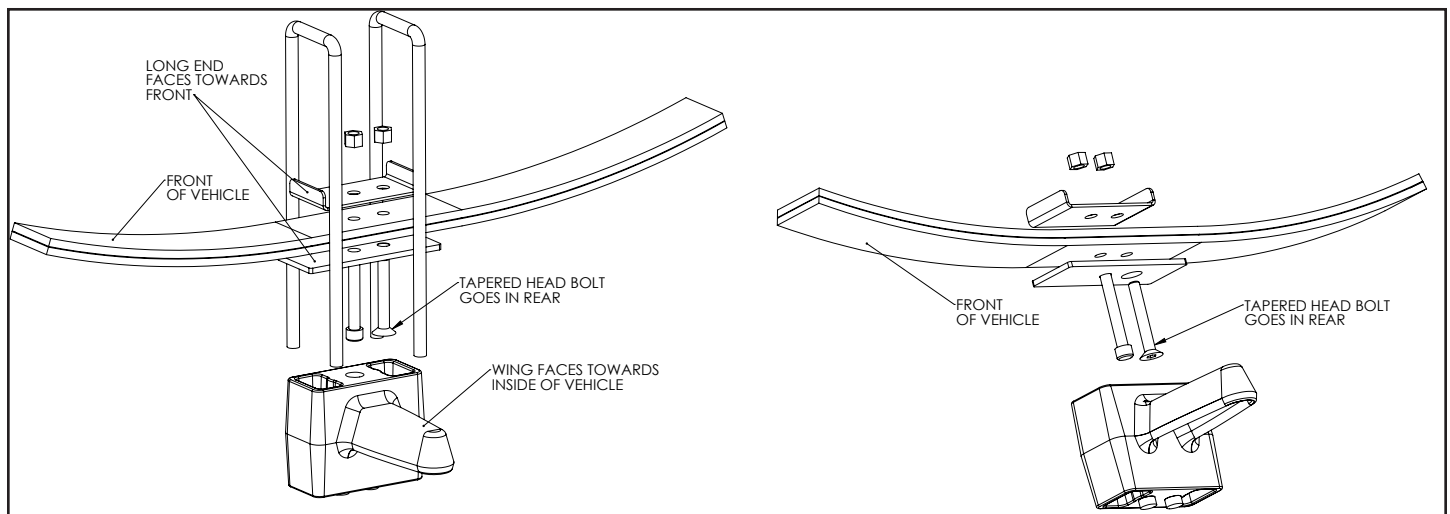
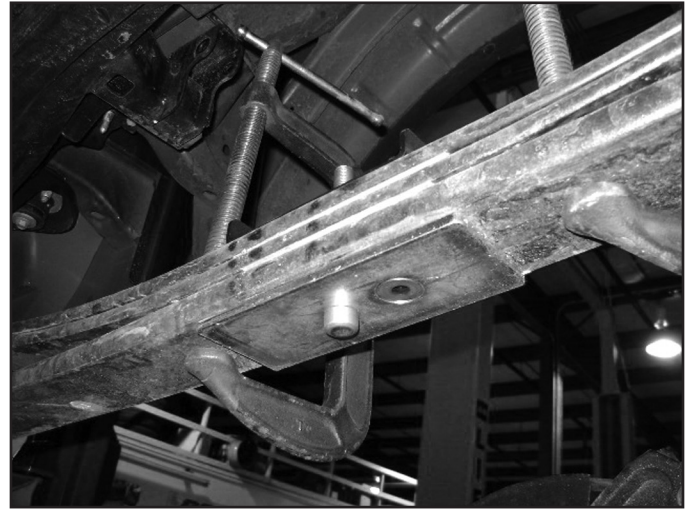


FIGURE 43B

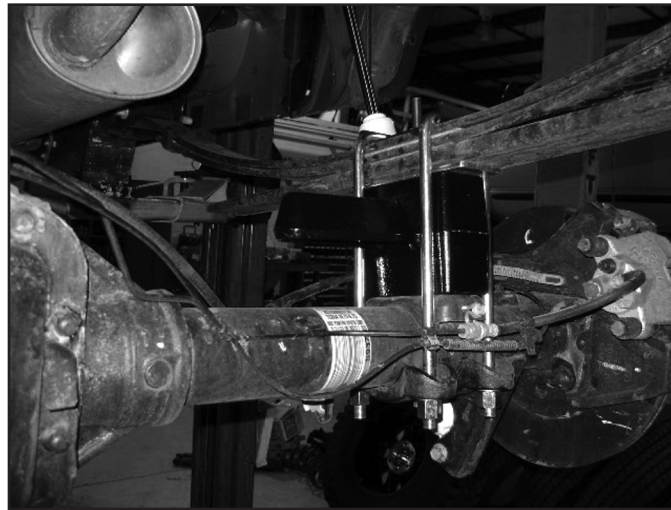


FIGURE 43C



88. Install the new provided lift block so that the bump stop wing goes toward the inside of the vehicle. The block will use the both of the lower center pin holes. The upper only uses 1 hole which will shift the axle slightly forward.
89. Raise the axle/block to the spring while aligning the center pin. Fasten the spring/block assembly with the provided square u-bolts, high nuts and washers (Bolt Pack #895). Snug u-bolts, they will be torqued with the weight of the vehicle on the springs. (Fig. 44)

FIGURE 44

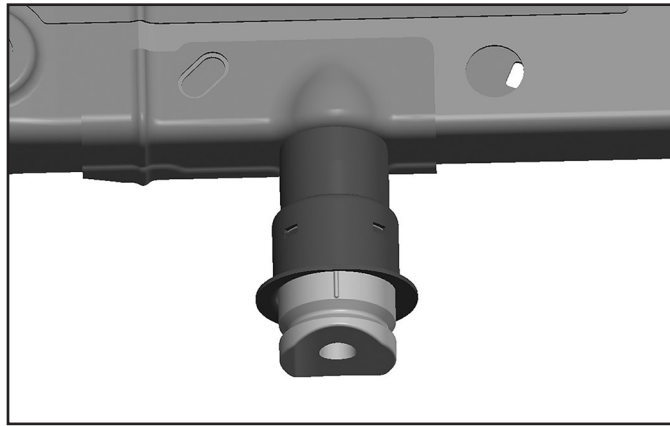


90. Repeat installation procedure on the opposite side of the vehicle.

4", 3-1/4", OR 2" REAR BLOCK KIT

91. **4" Block Kits Only:** Install rear block (02429 - DRV side, 02430 - Pass side). The block is designed to offset the axle forward slightly. The bump stop wing will be centered under the bump stop on the frame with the vertical gusset facing towards the front of the vehicle. Align the center pins and raise axle.
92. **3-1/4" or 2" Block Kits Only:** Install the rear blocks. Align the center pins and raise axle.
93. Attach radiused u-bolts with the factory lower u-bolt plate, factory upper u-bolt plate, high nuts and washers (Bolt Pack #896). Snug u-bolts, they will be torqued with the weight of the vehicle on the springs
94. **3-1/4" or 2" Block Kits Only:** Remove the factory bump stop. There is a bolt in the center of it attaching it to the frame.
95. **3-1/4" or 2" Block Kits Only:** Place the proved bump stop extension between the frame and the bump stop cup and fasten with the provided 10mm x 80mm bolts and washers (Bolt Pack #896). Hold the bump stop extension so it remains centered on the cup as the bolt is tightened (Fig. 45). Tighten hardware to 35 ft-lbs.

FIGURE 45



CCD MODELS ONLY

96. Install shock relocation brackets to the axle with supplied sleeve (133) and hardware. (Bolt Pack #354 & #941) Each shock relocation consists of an inside and outside mount. The larger piece (05303) will go on the outside left of the factory bracket and the smaller piece (05304) goes on the inside right. (Fig 46) The driver and passenger side mounts on axle will be identical. Leave hardware loose.

FIGURE 46

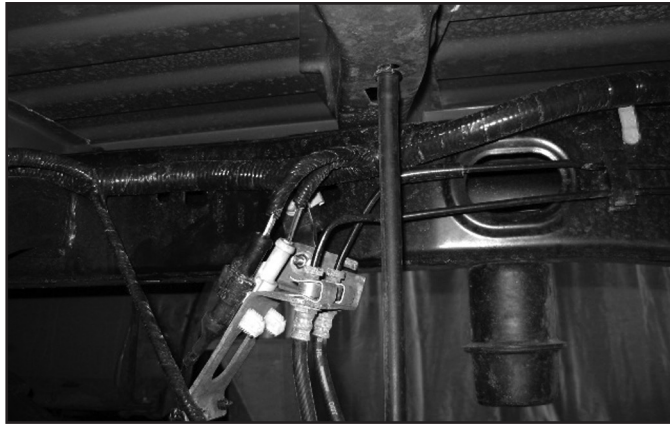


97. Attach lower shock with factory hardware, snug hardware but do not tighten at this time.
98. Torque 3/8" hardware to 44 ft-lbs.

ALL KITS FINAL INSTALLATION

99. Install the provided brake line relocation bracket (05025) to the driver's side frame rail with the OE brake line bracket bolt (Fig 47). Torque to 15 ft-lbs. Line up the tab with the factory slot.

FIGURE 47



100. For rear 4" & 5" kits, Vehicles equipped with a factory dual exhaust have the brake lines ran down the center. Install the provided 5/8"x1-7/8" Sleeve using BP1100 to space the brake line bracket off the rear axle. (Fig 48)

FIGURE 48



101. Attach the brake line to the relocation bracket with the 5/16" bolt, nut and washer (Bolt Pack #896 or #895). Torque to 15 ft-lbs. The brake line will need to be slightly deformed down to install into the new brake line bracket.

102. Install the provided new shocks with the OE hardware if not installing the factory shocks. Torque all shock hardware to 60 ft-lbs.

Note: 2.5 Piggyback shocks require the reservoir to be mounted towards the rear of the vehicle on both driver and passenger sides with the reservoir mounted on the frame side. The DSC adjusters can contact the shock mount on the driver side if mounted towards the front of the vehicle.

103. Install the wheels and lower the vehicle to the ground.

104. Bounce the rear of the vehicle to settle the suspension.

105. Torque the u-bolts to 100-120 ft-lbs.

FINAL INSTALLATION NOTES

106. Check all lines/wires for proper slack.

107. Reconnect the power steering control module connector.

108. Check all hardware for proper torque

109. Check hardware after 500 miles.

110. A complete front end alignment is necessary.

111. Adjust headlights.



WE WANT TO SEE YOUR RIDE!

Grab photos of your BDS-equipped truck in action and send them in for a chance to be featured. Send it in to our Bad Ass Rides customer gallery at bds-suspension.com/bar and post them on the BDS Fan Page on Facebook at facebook.com/BDSSuspensions. Don't forget about your BDS swag! BDS offers t-shirts, hoodies, decals and more available on the BDS website or through your local BDS distributor.

TIME TO HAVE SOME FUN

Thank you for choosing BDS Suspension.

For questions, technical support and warranty issues relating to this BDS Suspension product, please contact your distributor/installer before contacting BDS Suspension directly.

2021 FORD F150 4WD LIFT SYSTEM TORQUE SPECIFICATIONS

COMPONENT	TORQUE (FT-LBS)
9/16" or 14mm Differential Hardware	95
18mm Cross Member Hardware	250
1/2" Differential Skid Plate Bolts	65
Sway Bar Drop to Frame Hardware (Factory Hardware)	46
Strut Spacer to Strut Nuts	52
Hub Bolts	129
6mm Vacuum Hub Bolts	106 In-lbs
6mm Dust Shield Bolts	133 In-lbs
Upper Ball Joint Nut	46
Lower Ball Joint Nut	98
Upper Strut Nuts	52
Lower Strut Nuts	66
CV Shaft Nut	30
Tie Rod to Steering Knuckle	66
Brake Rotor to Steering Knuckle	184
Brake Line Relocation to Frame	15
8mm Brake Line to Steering Knuckle Bolts	169 In-lbs
7/16" Sway Bar to Sway Bar Drop Hardware	46
Sway Bar Link Hardware	111
Drive Shaft Bolts	41
Lower Control Arm Cams	250
Center Pin Nuts	35
Rear Brake Line Relocation Bracket to Frame	15
Rear Brake Line to Relocation Bracket	15
Rear Bump Stop Spacer (4" Kits Only)	41
Rear Shocks	60
Rear U-Bolts	100-120