

INSTALLATION GUIDE



Part#: 021653



HARDCORE LIMITED LIFETIME WARRANTY

4.5" & 6.5" High Clearance Suspension System

Chevy/GM 2500/3500 HD Pickup 2WD/4WD | 2011-2019

Rev. 010526

491 W. Garfield Ave., Coldwater, MI 49036 • Phone: 517-279-2135

E-mail: tech-bds@ridefox.com

Read And Understand All Instructions And Warnings Prior To Installation Of System And Operation Of Vehicle.



THANK YOU

Your truck is about to be fitted with the best suspension system on the market today. That means you will be driving the baddest looking truck in the neighborhood, and you'll have the warranty to ensure that it stays that way for years to come. Thank you for choosing BDS Suspension!

BEFORE YOU START

BDS Suspension Co. recommends this system be installed by a professional technician. In addition to these instructions, professional knowledge of disassembly/ reassembly procedures and post installation checks must be known.

FOR YOUR SAFETY

Certain BDS Suspension products are intended to improve off-road performance. Modifying your vehicle for off-road use may result in the vehicle handling differently than a factory equipped vehicle. Extreme care must be used to prevent loss of control or vehicle rollover. Failure to drive your modified vehicle safely may result in serious injury or death. BDS Suspension Co. does not recommend the combined use of suspension lifts, body lifts, or other lifting devices. You should never operate your modified vehicle under the influence of alcohol or drugs. Always drive your modified vehicle at reduced speeds to ensure your ability to control your vehicle under all driving conditions. Always wear your seat belt.

BEFORE INSTALLATION

- Special literature required: OE Service Manual for model/year of vehicle. Refer to manual for proper disassembly/reassembly procedures of OE and related components.
- Adhere to recommendations when replacement fasteners, retainers and keepers are called out in the OE manual.
- Larger rim and tire combinations may increase leverage on suspension, steering, and related components. When selecting combinations larger than OE, consider the additional stress you could be inducing on the OE and related components.
- Post suspension system vehicles may experience drive line vibrations. Angles may require tuning, slider on shaft may require replacement, shafts may need to be lengthened or trued, and U-joints may need to be replaced.
- Secure and properly block vehicle prior to installation of BDS Suspension components. Always wear safety glasses when using power tools.
- If installation is to be performed without a hoist, BDS Suspension Co. recommends rear alterations first.
- Due to payload options and initial ride height variances, the amount of lift is a base figure. Final ride height dimensions may vary in accordance to original vehicle attitude. Always measure the attitude prior to beginning installation.



Visit 560plus.com for more information.

TIRES AND WHEELS

6.5" Kit:

- 37 x 12.50 on 17" x 9" w/ 4-1/2 to 4-5/8" Backspacing
- 37 x 12.50 on 18" x 9" w/ 4-1/2 to 4-5/8" Backspacing
- 37 x 12.50 on 20" x 9" w/ 5 to 6" Backspacing
- Larger than 20", use 20" wheel specs

Stock 20" x 8.5" wheels with 6.18" backspacing MAY fit with a max tire size of 37x12.50 on certain tire sidewall profiles due to clearance to the steering knuckle and sway bar. A minimum 1/4" wheel spacer may be required due to tire side wall profile variations. A wider tire will cause clearance issues with the steering knuckle.

4.5" Kit: Same as above, except with maximum 35x12.50 size

BEFORE YOU DRIVE

Check all fasteners for proper torque. Check to ensure for adequate clearance between all rotating, mobile, fixed, and heated members. Verify clearance between exhaust and brake lines, fuel lines, fuel tank, floor boards and wiring harness. Check steering gear for clearance. Test and inspect brake system.

Perform steering sweep to ensure front brake hoses have adequate slack and do not contact any rotating, mobile or heated members. Inspect rear brake hoses at full extension for adequate slack. Failure to perform hose check/ replacement may result in component failure. Longer replacement hoses, if needed can be purchased from a local parts supplier.

Perform head light check and adjustment.

Re-torque all fasteners after 500 miles. Always inspect fasteners and components during routine servicing.

CONTENTS OF YOUR KIT



011218 - 4.5" rear 2" kit - non overload

Part #	Qty	Description
2fb18	2	2" x 18mm pin blocks
343251350QB	4	3/4" x 3-1/4" x 13-1/2" square black
B1085	1	Bag Kit

011217 - 4.5" rear 2" kit - overload

Part #	Qty	Description
2fb18	2	2" x 18mm pin blocks
343251550QB	4	3/4" x 3-1/4" x 15-1/2" square black
B1085	1	Bag Kit

021454 - 4.5" kit only

Part #	Qty	Description
02766	1	Torsion Bar Brkt - DRV
02767	1	Torsion Bar Brkt - PASS
02367	2	Hex Eliminator - Front
02368	2	Hex Eliminator - Rear (Grooved)
03468	2	Torsion Bolt Retaining Bracket
587	1	Bolt Pack

021652

Part #	Qty	Description
02362B	1	Front Crossmember
02373B	1	Crossmember Brace
32533D	1	Front Brake Line - DRV
32533P	1	Front Brake Line - PASS
5188	2	Brake Line Clip
590	1	Bolt Pack - Front Brake Lines
	6	Wire Clamp
	6	1/4"-20 x 3/4" bolt
	6	1/4" lock washer
	6	6mm Flat washer

021650-021651

Part #	Qty	Description
02360	1	Steering Knuckle - DRV
02361	1	Steering Knuckle - PASS
590	1	Bolt Pack
	6	Wire Clamp
	6	1/4"-20 x 5/8" Bolt, Grade 5, Zinc
	6	1/4" Lock Washer, Zinc
	6	6mm Washer (12mm OD), Zinc

021654 - 6.5" kit only

Part #	Qty	Description
02364B	1	Torsion Bar Bracket - DRV
02365B	1	Torsion Bar Bracket - PASS
02367	2	T-Bar Brkt Spacer - Front
02368	2	T-Bar Brkt Spacer - Rear (Grooved)
03468	2	Torsion Bolt Retaining Bracket
587	1	Bolt Pack - Torsion Bar Brackets
	2	1"-8 x 6" bolt
	4	1" USS flat washer
	2	1"-8 nylock nut
	2	14mm-2.00 x 70mm bolt
	4	14mm flat washer
	2	14mm-2.00 prevailing torque nut
	2	9/16" SAE flat washer
	2	6mm-1.00 hex nut

011318/011317

Part #	Qty	Description
3FBB18	2	3" Block
343251350QB	4	3/4x3-1/4x13-1/2 Square U-Bolt (011318 only)
343251550QB	5	3/4x3-1/4x15-1/2 Square U-Bolt (011317 only)
B1225G8	2	12mm-1.75x25mm socket head bolt
N34FLG-B	8	3/4" Serrated Flange Nut
02243	1	E-Brake Extension Tube
SBTE	1	6mm-1.00 x 95mm Threaded Rod

021653

Part #	Qty	Description
911109	2	Sway Bar Link
02363B	1	Rear Crossmember
02369B	1	Differential Bracket - DRV
02370B	1	Differential Bracket - Center
02371B	1	Differential Bracket - PASS
02372B	1	Differential Skid Plate
01556	2	Upper Shock Mount
B12X114	4	1/2"-13 x 1-1/4" bolt
W12S	8	1/2" SAE Flat Washer
N12PT	4	1/2"-13 Prevailing Torque Nut
02129	2	Sway Bar Link Bracket
45313	2	0.625 x 0.109 x 1.375 Sleeve
S10076	4	Stem Washer
342701	2	Thread locker
70	1	Sleeve - Center Differential Bracket
3523BK	2	Bushing - Center Differential Bracket
SB58BK	2	Sway Bar Link Bushing
SB26BK	4	Stem Bushing
585	1	Bolt Pack - Lower Control Arms
	2	18mm-2.50 x 120mm bolt
	2	18mm-2.50 x 140mm bolt
	4	18mm-2.50 prevailing torque nut
	8	3/4" SAE flat washer clear zinc
586	1	Bolt Pack - Main Assembly
	6	1/2"-13 x 1-1/4" bolt
	2	1/2"-13 x 1-1/2" bolt
	2	1/2"-13 x 3-1/2" bolt
	4	1/2"-13 prevailing torque nut
	12	1/2" SAE flat washer
	4	7/16" USS flat washer
	2	12mm-1.75 x 40mm bolt
	1	9/16"-12 x 4" bolt
	1	9/16"-12 prevailing torque nut
	2	9/16" SAE flat washer
	4	10mm-1.50 x 40mm bolt
	4	10mm flat washer
	4	10mm flat washer

021653 Continued

582	1	Bolt pack - Sway Bar Links
	2	7/16"-14 nylock nut - clear zinc
	2	3/8"-16 x 2-1/2" bolt grade 8 - yellow zinc
Part #	Qty	Description
	4	3/8" SAE washer yellow zinc
	2	3/8"-16 Prevailing torque nut - yellow zinc
	2	5/8" SAE washer clear zinc
	2	5/8"-11 nylock nut clear zinc

021509/021508

Part #	Qty	Description
5FB18	2	Rear 5" Block w/Wing
02415	2	U-Bolt Plate
344001812RB	4	3/4x4x18-1/2 Round U-Bolt (021508 only)
344001600RB	4	3/4x4x18-1/2 Round U-Bolt (021509 only)
02243	1	E-Brake Extension Tube
SBCA	1	Rear Brake Line Extension
SBTE	1	6mm-1.00 x 95mm Threaded Rod
N34FLG-B	8	3/4" Serrated Flange Nut
588	1	Bolt Pack - Rear
	1	1/4"-20 x 1" bolt
	1	1/4"-20 x 1" self threading bolt
	2	1/4" USS flat washer
	1	1/4"-20 prevailing torque nut
	1	6mm-1.00 coupler nut
	2	6mm-1.00 hex nut

121650

Part #	Qty	Description
02380	1	Front Skid Plate

TECH TIPS

1. Do not install this suspension system in conjunction with any type of torsion bar lift keys.
2. Disassembly/assembly of the factory torsion bar system requires the use of a special unloading tool. The GM specified tool # is CH48809.
3. Some minor trim will be required with certain wheel/tire combination. This is normal with most aftermarket tire/wheel fitment on Chevy/GM trucks. Trimming will normally include the bottom edge of the inner fender shrouds and/or lower corner of front bumper valance. As a rule of thumb, deeper backspacing and shorter/narrower tires will reduce/eliminate trimming required. Further trimming tips are included at the end of this instruction sheet.

INSTALLATION INSTRUCTIONS

FRONT INSTALLATION

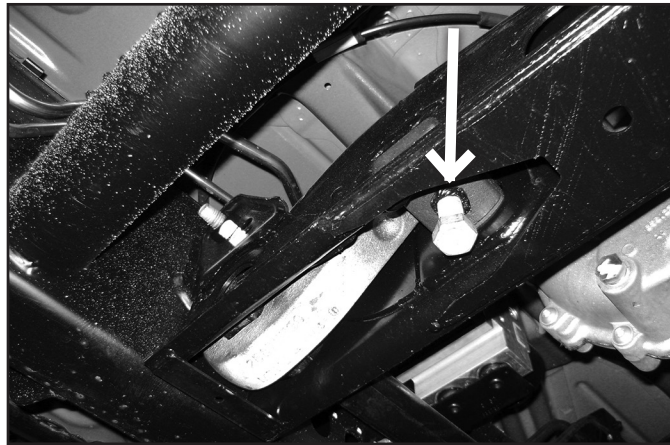
1. Park the vehicle on a flat, clean surface and block the rear wheels for safety.
2. Disconnect the positive & negative battery cables from the battery
3. Raise the front of the vehicle and support with jack stands under the frame rails.
4. Remove the wheels.
5. Measure and record the length of the exposed thread on the torsion bar adjuster bolts (Fig 1). Record the lengths here for use later during the installation

DRV Side: _____ PASS Side: _____

SPECIAL TOOLS

1-1/2" (38mm) socket/wrench
34mm socket
T30 Torx bit
1-1/16" (27mm) socket/wrench
Torsion Bar Unloading tool (see Pre-Installation Note #2)
Reciprocating Saw
4" Cut-off Wheel/Tool (optional)
Pair of Large (8-10") C-Clamps

FIGURE 1



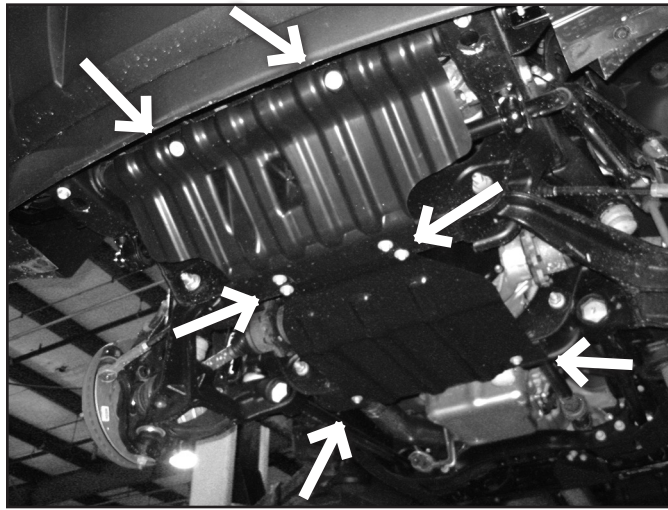
6. Unload the torsion bars but do not remove. Remove and save adjuster bolt/retainer block.



Tip Torsion bars are under extreme pressure. A proper torsion bar tool is necessary to unload the bars. A tool designed specifically for GM torsion bars is required see troubleshooting note #2.

7. Mark the unloaded torsion bars to indicate DRV side and PASS side. Also mark the bars to indicate front versus rear.
8. Remove the torsion bar adjuster plate by pushing the torsion bar forward to allow the plate to drop free. On some vehicles this will require using a hammer/punch or air hammer. Access the end of the torsion bar through the hole in the back of the torsion bar crossmember and drive forward. Leave the torsion bars in the lower control arms. Be mindful of the ABS module along the frame rail in front of the crossmember on the drivers side on some models.
9. Remove the front plastic splash guard, save splash guard bolts. If equipped, remove the four bolts mounting the factory belly pan to the frame (Fig 3) These will not be reused.

FIGURE 3



10. Disconnect the sway bar end links from the sway bar and the lower control arms (Fig 4A). Discard the link assemblies.
11. Disconnect the tie rod ends from the steering knuckles (Fig 4A). Remove the tie rod end nuts and save. Strike the knuckle near the tie rod end to dislodge the tie rod end taper (Fig 4B). Remove the tie rod ends from the knuckles.

FIGURE 4A

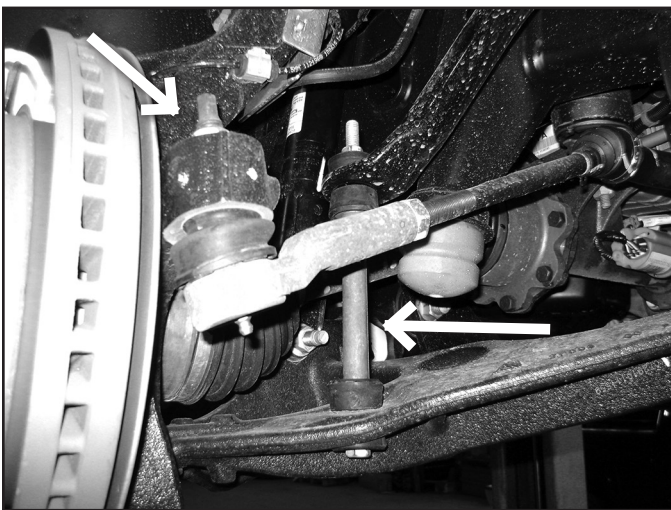


FIGURE 4B



12. Disconnect the ABS brake wire from the connector at the frame (Fig 5) Remove the wire from the plastic retainers on the frame and brake line bracket on the steering knuckle (Fig 6).
13. Disconnect the rubber brake line bracket from the steering knuckle (Fig 6).

FIGURE 5

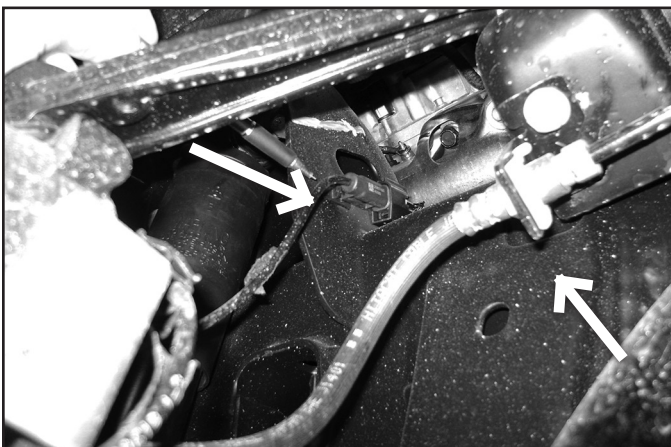
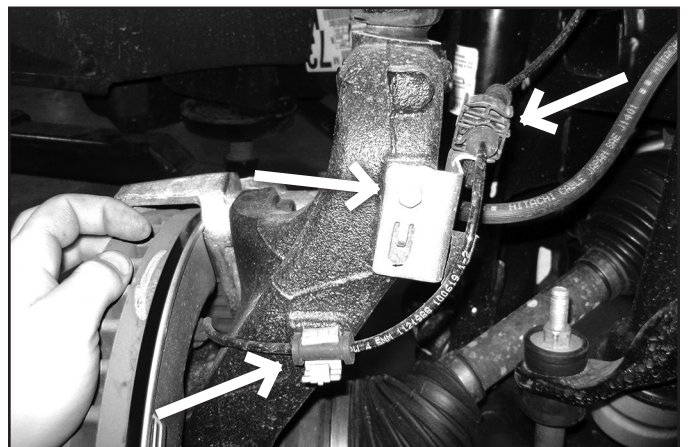


FIGURE 6



14. Remove the two bolts mounting the brake caliper assembly to the steering knuckle and hang the caliper out of the way (Fig 7). Do not hang the caliper by the brake hose. Save mounting bolts.

FIGURE 7



15. Carefully remove the hub dust cover. Save cover (Fig 8). Tip: Carefully work the cover loose with a small chisel.
16. Remove the rotor retaining bolt using a T30 torx bit (Fig 9). Remove the brake rotor and set aside. Save retaining bolt.
17. Remove the CV axle nut and washer (Fig 9). Save hardware.

FIGURE 8

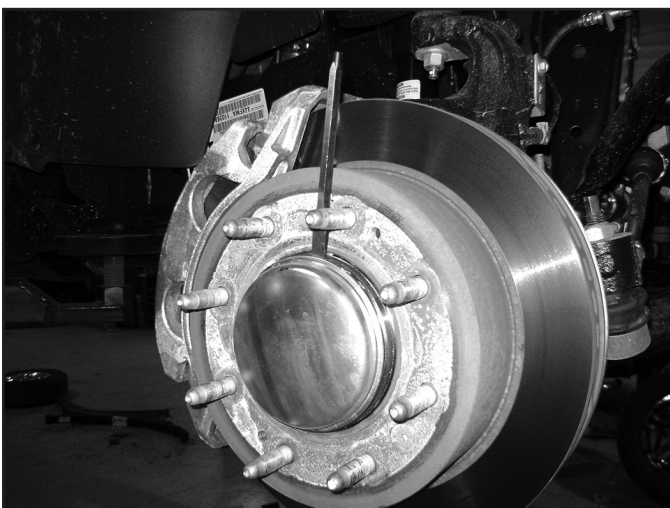
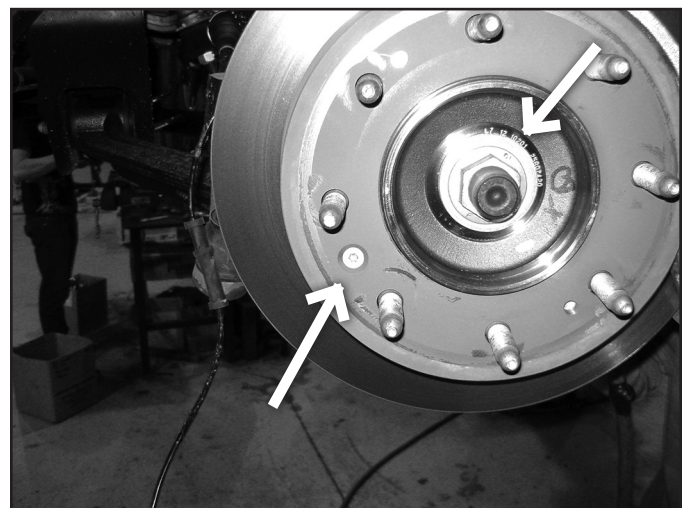
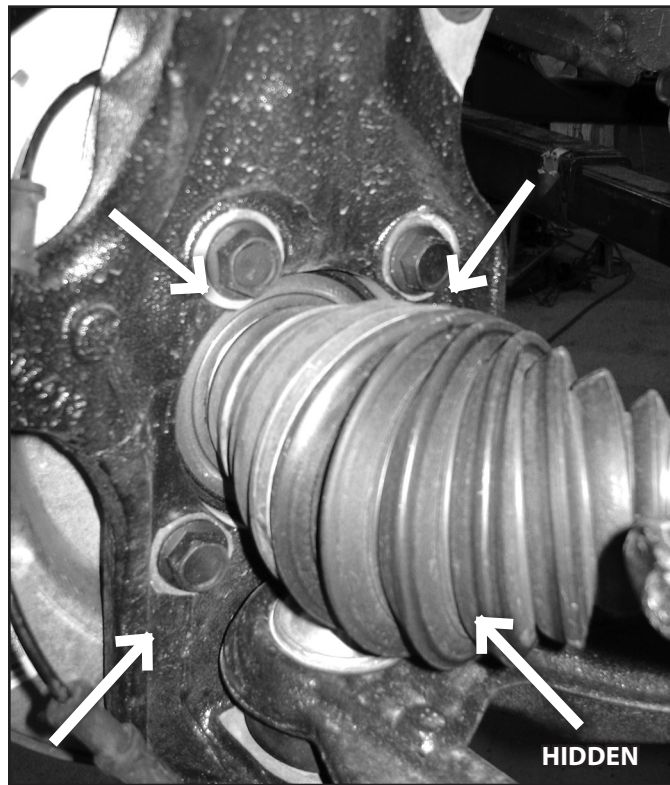


FIGURE 9



18. Locate and remove the four hub bearing assembly bolts (Fig 10). The bolts are accessed from the back side of the steering knuckle. Remove the hub bearing assembly and dust shield from the steering knuckle.

FIGURE 10



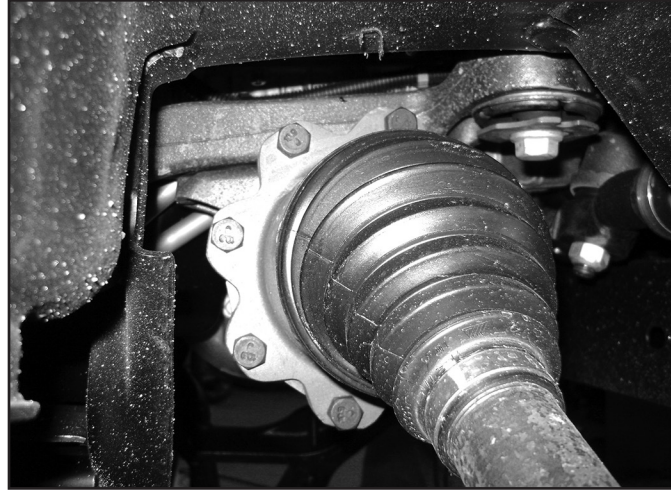
19. Remove the upper and lower ball joint nuts (Fig 11). Reinstall the nuts a couple of turns by hand. Strike the knuckle near the ball joints to release the taper. Remove the nuts and remove the steering knuckle from the vehicle. Save nuts. Take care not to strike the ball joint.

FIGURE 11



20. Remove the CV axle flange bolts at the differential (Fig 12). There are 8 bolts per side. Remove the CV shafts from the vehicle and set aside. Save bolts.

FIGURE 12



21. Disconnect the shocks from the frame (Fig 13A) and lower control arm (Fig 13B). Remove shocks. Save the lower shock mount hardware.

FIGURE 13A

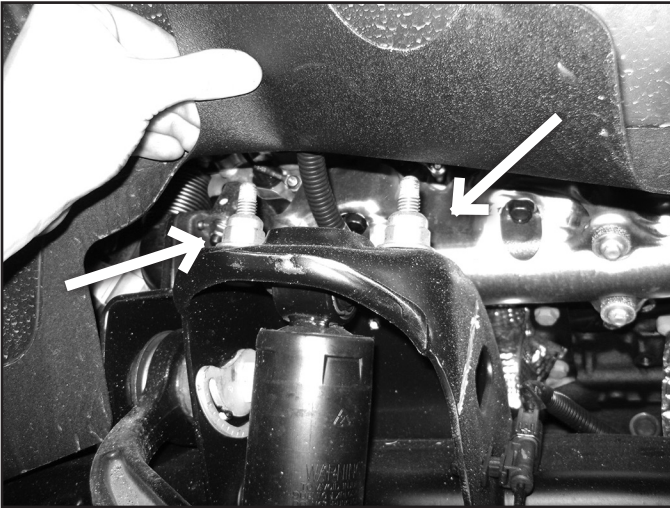
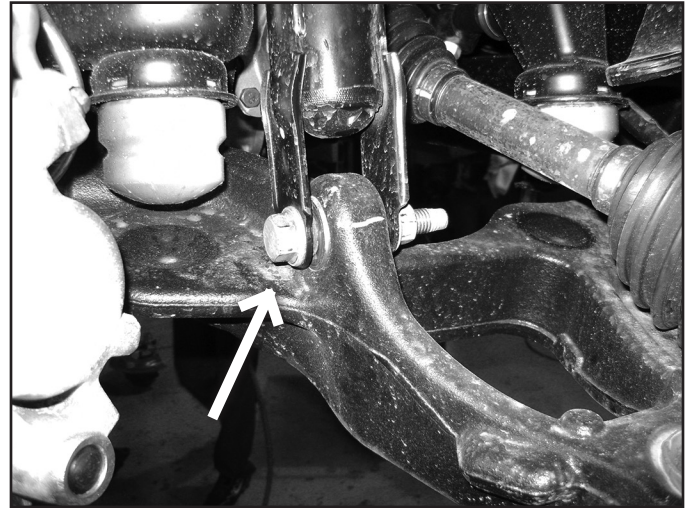


FIGURE 13B



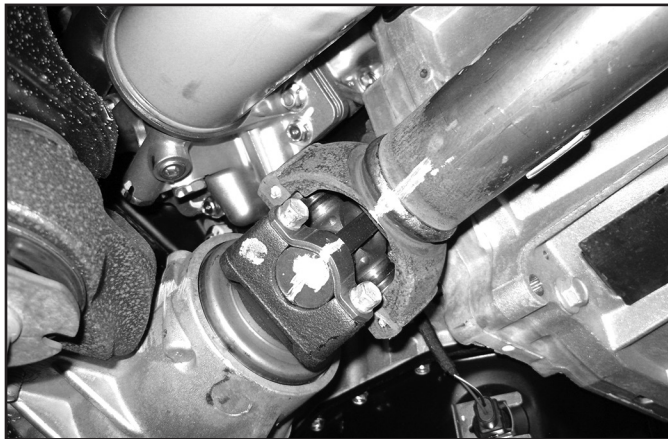
22. Remove the front and rear lower control arm bolts and remove the control arms from the vehicle (Fig 14) Save the control arms and mounting hardware.

FIGURE 14



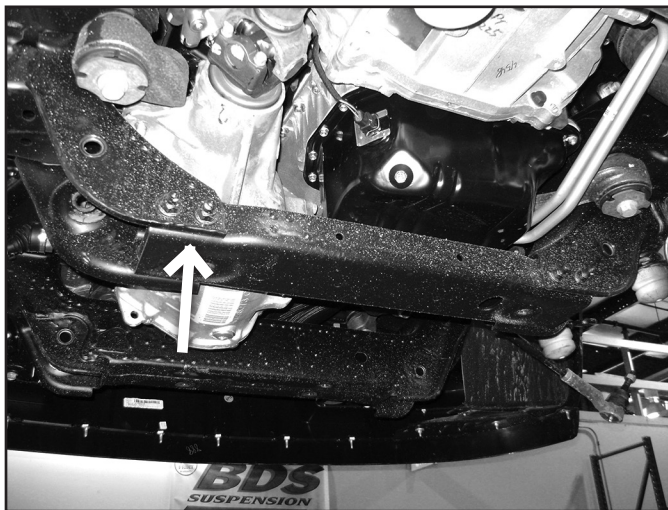
23. There are two factory bump stops per side. Remove the front rubber bumpstop from the frame mounts on each side. They can be removed with a pair of channel-lock pliers.
24. Make an alignment mark on the front driveshaft and front differential input yoke. Remove the four bolts/clamps from the yoke and remove the front driveshaft from the differential (Fig 15). Save the driveshaft hardware.

FIGURE 15



25. Remove the four bolts mounting the rear crossmember to the rear lower control arm pockets (Fig 16). Remove the crossmember from the vehicle. The crossmember and hardware will not be reused.

FIGURE 16



26. Disconnect the electrical connector from the front differential actuator (Fig 17A) Remove the wire from the three plastic wire retainers along the top of the differential. Disconnect the axle breather tube from the top of the driver's side of the differential (Fig 17B).

FIGURE 17A



FIGURE 17B



27. Loosen but do not remove all of the front differential mounting bolts/nuts. There are two nuts on the passenger's side (Fig 18A) and three bolts on the driver's side (Fig 18B - two mount from the bottom up and one from the top down). Remove the rear-most bolt mounting from the top.

FIGURE 18A

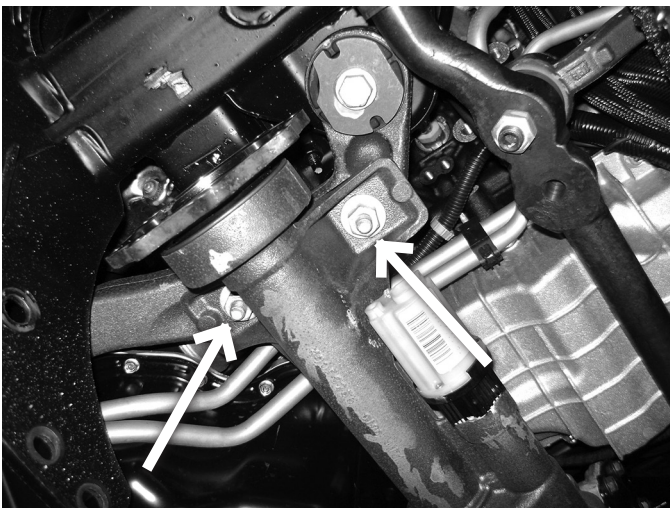
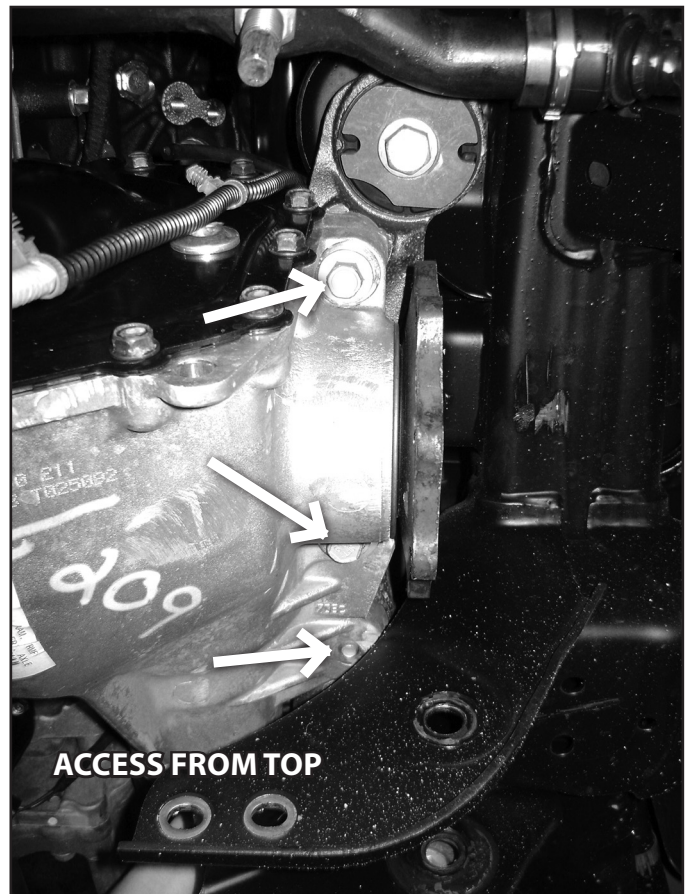


FIGURE 18B



28. Support the front differential with an appropriate jack. Remove the differential mounting hardware and lower the differential from the vehicle and set aside. Save hardware.

29. The lower rear driver's side control arm pocket must be trimmed to provide clearance for the front differential. On the front face measure from the center of the control arm mounting hole inward 1-1/4" and mark. Fig. 19A On the back face measure from the center of the control arm mounting hole inward 2-1/2" and mark. Fig. 19B Make vertical cut lines at the marks on the front and back faces. Along the top, connect the front and back cut lines with a diagonal cut. Fig. 19C

FIGURE 19A



FIGURE 19B

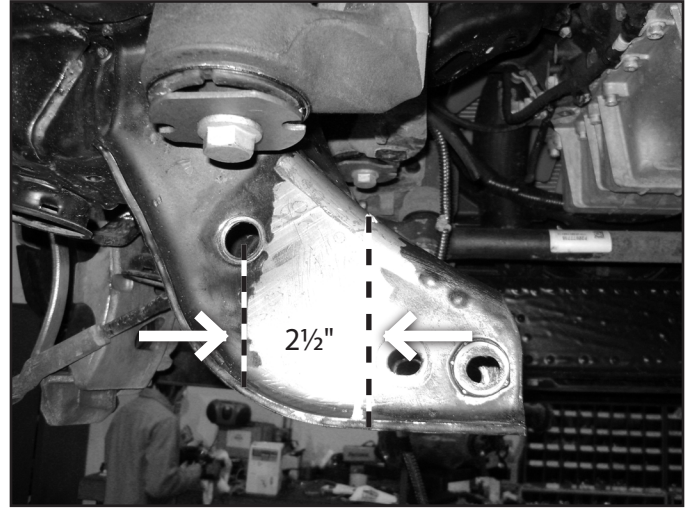
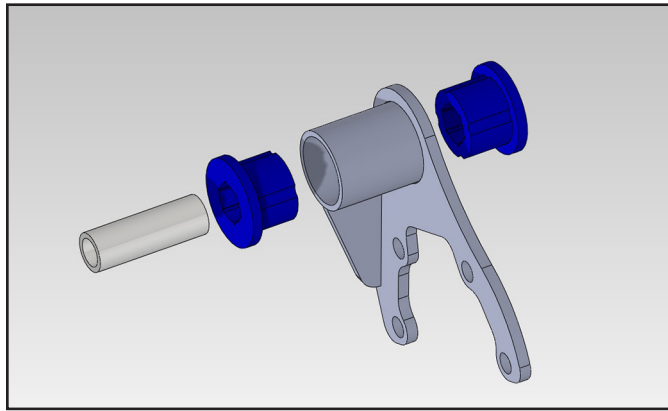


FIGURE 19C



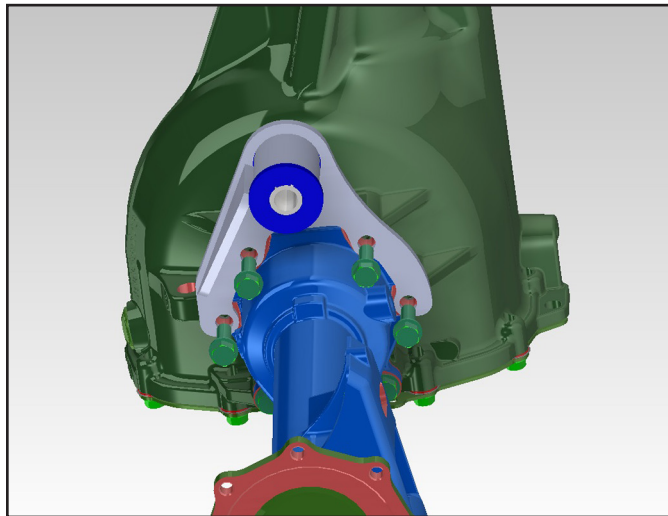
30. Using a reciprocating saw (recommended), hack saw or cut-off wheel, cut the pocket along cut lines. Remove any burrs or rough edges and paint any bare metal to prevent corrosion.
31. Install the provided large bushings (3523) and 0.875" OD x 2.620" long sleeve (70) into the eye of the new center differential bracket (02370) (Fig 20).

FIGURE 20



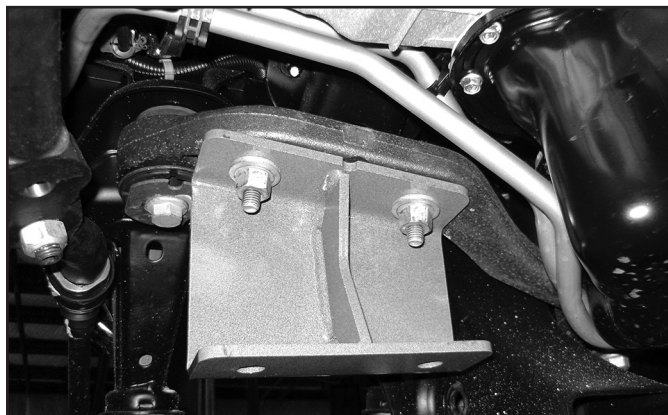
32. Locate the 4 housing bolts to be removed. Remove the four bolts, place the bracket in position and fasten with new 10mm x 40mm bolt and washers (BP 586). The bracket gusset will be toward the bottom of the differential (Fig 21). Use Thread locker on the bolt threads and torque to 40 ft-lbs.

FIGURE 21



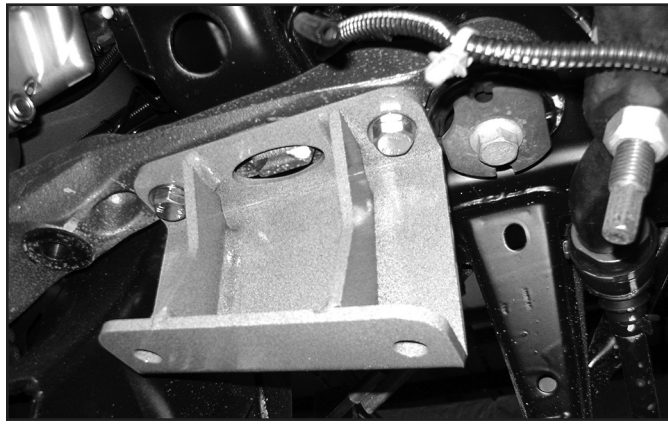
33. Locate the new passenger's side differential bracket (02371). Bracket has a single center gusset. Install the bracket on the existing studs on the passenger's side factory bracket. Fasten with the original nuts and washers. When installed the open side of the bracket will face inward and the bracket will taper down as it goes to the rear (Fig 22). Torque nuts to 65 ft-lbs.

FIGURE 22



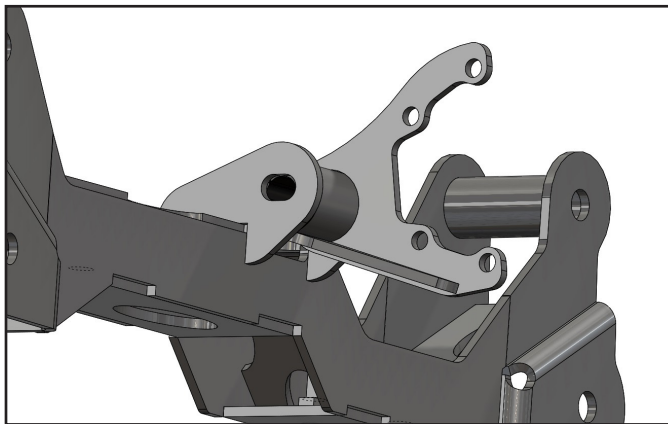
34. Locate the new driver's side differential bracket (02369). Bracket has two center gussets. Install the bracket to the 2 front original differential mounting holes with the provided 12mm-1.75 x 40mm bolts and 1/2" SAE washers (BP 586), applying Thread locker to the threads before installation. When installed the open side of the bracket will face inward and the bracket will taper down as it goes to the rear (Fig 23). Torque bolts to 65 ft-lbs.

FIGURE 23



35. Using an appropriate jack, raise the differential up into the vehicle. Align the differential mounting holes to the new driver's and passenger's side differential brackets. Fasten to the driver's side mount with 1/2" x 3-1/2" bolts, nuts and 1/2" SAE flat washers (BP 586). Fasten the passenger's side 1/2" x 1-1/2" bolts, nuts and heavy 1/2" (large OD) washers (BP 586). Leave hardware loose.
36. Locate the new rear crossmember (02363). Install the crossmember in the rear lower control arm pockets with the factory control arm bolts/nuts. Run the bolts from rear to front. The center differential bracket will fit into the mount tabs on the crossmember. Fasten the differential mount to the crossmember with a 9/16" x 4" bolt, nut and 9/16" SAE washers (BP 586). Leave hardware loose. (Fig 24)

FIGURE 24

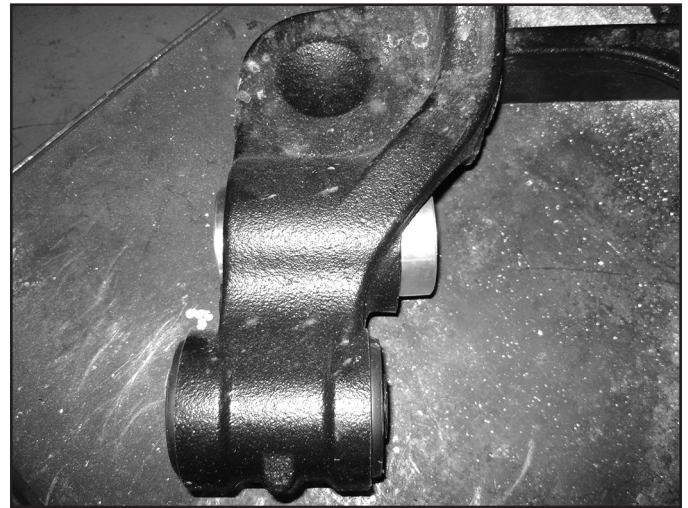


37. Check to ensure the rear differential clears the rear cross member/frame where the frame was trimmed. It may be necessary to clearance the differential house at this point.
38. With the differential and rear crossmember installed, tighten all the differential mount hardware. Torque the (4) 1/2" bolts to 65 ft-lbs and (1) 9/16" bolt to 95 ft-lbs.
39. Reconnect the front driveshaft to the front differential with the factory clamps and bolts. Torque hardware to 25 ft-lbs.
40. Reconnect the front differential actuator wire. Reattach the wire harness to the housing. Use the provided zip ties where needed. Pull down on the differential breather hose to gain slack and reconnect to the top of the differential.
41. Locate the new front crossmember. Install the crossmember in the front lower control arm pockets and fasten with the original control arm bolts/nuts. Run the bolt from front to rear. Leave hardware loose.
42. Locate the new provided aluminum torsion bar bracket spacers. There are 2 pairs of spacer. One pair has a groove cut in the flange which mount in the back side of the torsion bar hex holes in the factory lower control arms. The other pair mount in the front position (Fig 25A/B).

FIGURE 25A



FIGURE 25B



43. Locate the new torsion bar brackets (02364/02365 - 6.5" Kit or 02766/02767 4.5" Kit). They are driver's and passenger's side specific. Slide the bracket onto the appropriate arm and fasten through the aluminum spacers with the provided 1" x 6" bolts, nuts and washers (BP 587). Check for clearance where the large offset bend is near the arm. **SOME** factory arms will need to be clearance slightly in this area to get the bolt into the stock shock location. Grind off a small amount if necessary, coat with paint (Fig 26a, 26b). Run the bolts from front to back (Fig 26c). The brackets will also align with the factory shock mount. Place a provided 9/16" SAE washer (BP 587) between the front bracket tab and the factory shock mount (Fig 26d). Fasten with the factory lower shock bolt/nut. Leave all hardware loose.

FIGURE 26A



FIGURE 26B

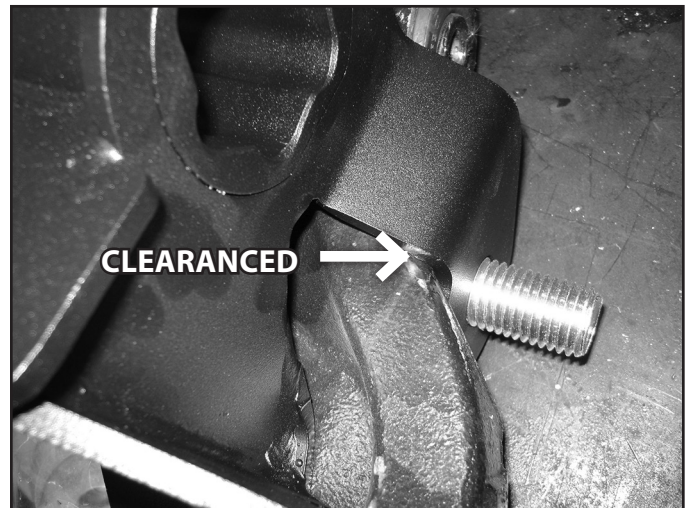
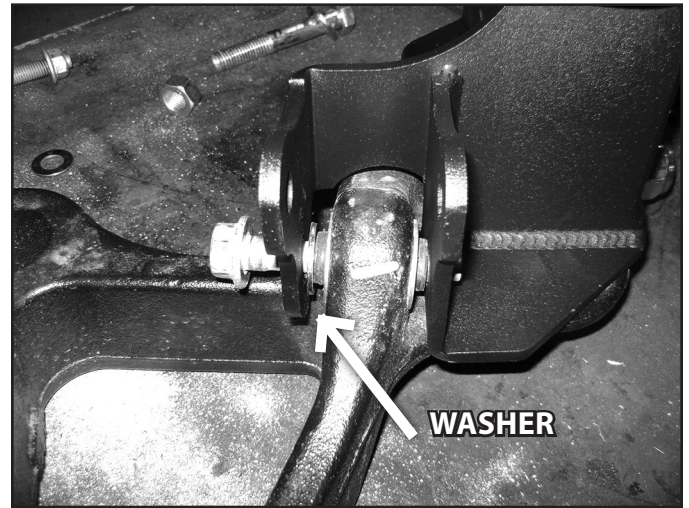


FIGURE 26C

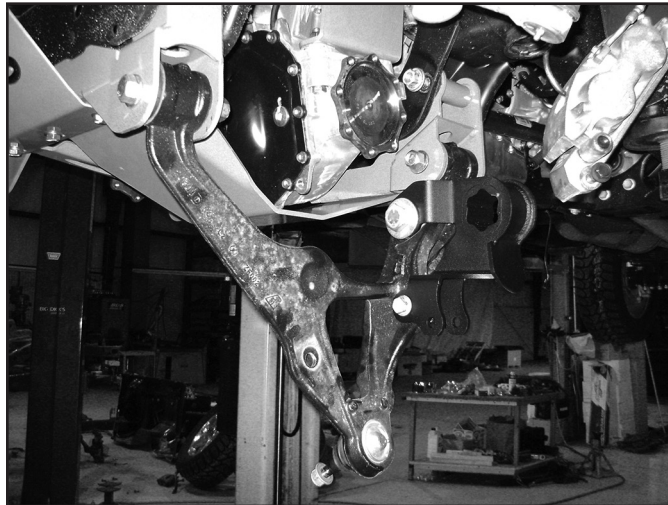


FIGURE 26D



44. With both new torsion bar bracket installed on the factory control arms, install the control arms in the cross members. Fasten the control arms with the provided 18mm x 120mm (front) and 18mm x 140mm bolts, nuts and 3/4" SAE flat washers (BP 585). Run the front bolts front-to-rear and the rear bolts rear-to-front. (Fig 27) Leave hardware loose. These bolts will be torque with the weight of the vehicle on the suspension.

FIGURE 27



45. Locate the new differential skid plate (02372). Position the skid plate so that it aligns to holes with the welded nuts on the bottom driver's side of the rear crossmember (Fig 30). Fasten the skid plate with 1/2" x 1-1/4" bolts and 1/2" SAE washers (BP 586). Snug hardware so the front of the skid plate sets up near the bottom of the front crossmember.
46. Locate the new crossmember support brace (02373). The brace is formed to clear the differential actuator when installed. Position the support brace so it sets properly against the bottom of the front and rear cross members and aligned to the mounting holes. Fasten the tube to the rear crossmember with a 1/2" x 1-1/4" bolt and 1/2" SAE washer (BP 586). Again, snug hardware so the brace sets up near the bottom of the front crossmember (Fig 29).
47. Locate the new front "BDS" skid plate/splash guard (02380). Loosely attach the skid plate to the original splash guard mounting holes on the upper frame crossmember using the original splash guard bolts. (Fig 28A) Position the skid plate up to the bottom of the front crossmember "sandwiching" the support brace and differential skid plate. Fasten the front skid plate, differential skid plate and support tube to the front crossmember with 1/2" x 1-1/4" bolts and 1/2" SAE washers (BP 586) in the welded nuts in the crossmember (Fig 28B). Apply Thread locker to the bolt threads and torque to 55 ft-lbs.
48. With the front hardware tight, remove the rear bolts one at a time and apply Thread locker to the threads. Reinstall and torque to 55 ft-lbs. Torque the front factory splash guard bolts to 25 ft-lbs.
49. After all the skid plate hardware is tight, go back and torque the 4 factory lower control arm pocket bolts (mounting the new cross members) to 250 ft-lbs.

50. Locate the new steering knuckles and identify the driver's and passenger's side. Install the appropriate knuckle on the lower control arm and fasten with the original lower ball joint nut. Swing the knuckle up and attach to the upper ball joint with the original nut. Torque the upper ball joint nut to 37 ft-lbs and the lower ball joint nut to 74 ft-lbs (Fig 30).

FIGURE 28



FIGURE 29

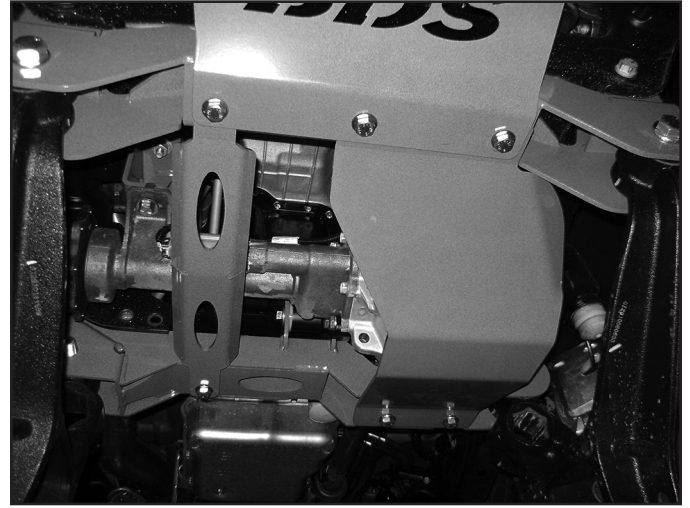


FIGURE 30



51. Locate the hub o-ring in the factory steering knuckle hub bores. Carefully remove the o-rings (Fig 31) and install into the new steering knuckles.

FIGURE 31



52. Locate the factory driver's and passenger's brake dust shields. They need to be modified to provide adequate brake caliper clearance. Make a cut line by following the straight edge on the caliper side of the shield all the way to the bottom edge of the shield. (Fig 32) Cut the shield along the line.

FIGURE 32

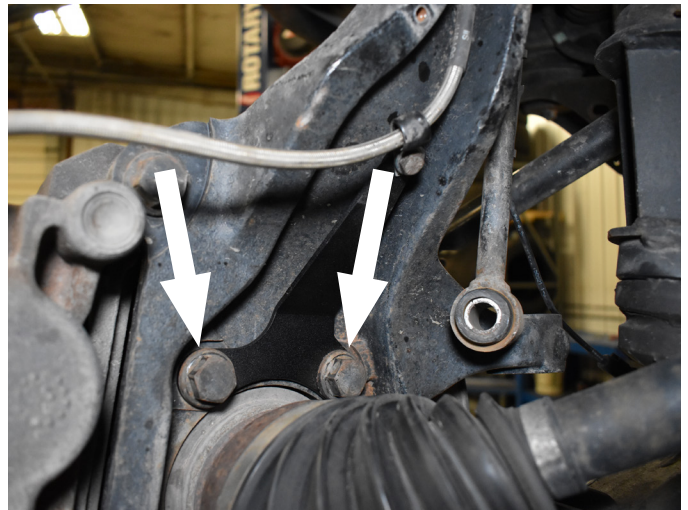


53. Install the hub assembly and dust shield into the appropriate steering knuckle. The ABS line will run out the top of the hub and behind the dust shield. (Fig 33A) Fasten the hub to the knuckle with the factory bolts along with the brake line routing bracket as shown in the figure below (05568 = DRV, 05569 = PASS. 05568 DRV shown below). Apply Thread locker to the threads and torque the hub bolts to 125 ft-lbs. (Fig. 33B)

FIGURE 33A

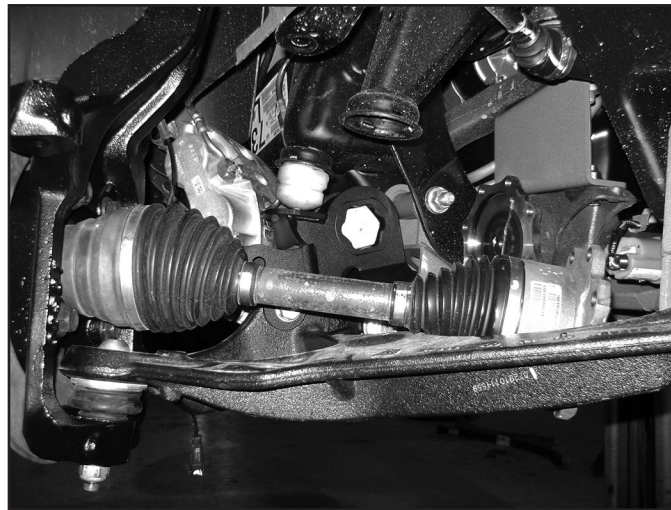


FIGURE 33B



54. Run the ABS line around the front of the steering knuckle and up to the wire connector on the frame. Reconnect the wire and reattach it to the original place on the frame.
55. Slide the torsion bars back to the crossmember and install the factory torsion adjuster keys. The torsion bars will be loaded at the end of the installation.
56. Locate the factory CV axle shafts. Install the CV axle into the hub assembly (Fig 34) and then onto the differential output flange. Align the differential flange holes and fasten with the factory bolts. Apply Thread locker to the threads and torque to 40 ft-lbs.

FIGURE 34



57. Install the original CV axle nut and washer and torque to 155 ft-lbs. Reinstall the hub dust cap.
58. Install the brake rotor on the hub by aligning the tapered retainer bolt hole in the rotor with the threaded hole in the hub flange. Fasten the rotor to the hub with the original retainer bolt and tighten securely with a T30 torx bit.
59. With the brake lines free, install the brake calipers on the knuckles with the original bolts. Apply Thread locker to the bolt threads and torque the bolts to 125 ft-lbs.
60. Using a 13mm line wrench disconnect the hardline from the rubber line. Remove the retaining clip and pull the line from the frame bracket. Place a bucket, etc under the hardline to catch any brake fluid drips.

61. Locate the new provided stainless steel brake lines (22533D/P). The lines are driver's and passenger's side specific. The caliper end has a offset jog. When install the hardline at the caliper will offset towards the inside of the vehicle. Identify the appropriate lines. (Fig 35 - Pass Side Shown)

FIGURE 35



62. Remove the factory brake line from the caliper. Be sure to remove the factory crush washers as well. Place a new provided crush washer on each face of the new brake line and install on the caliper with the factory banjo bolt. Torque the bolt to 20 ft-lbs.
63. Run the new brake line up to the factory frame mount bracket. Feed the end of the line through the bracket and fasten to the factory hardline. Using a 13mm line wrench on the hard line fitting and 18mm wrench on the new line, tighten the fitting securely. Secure the line to the factory bracket with the original brake line clip or the provided new one (5188). (Fig 36)

FIGURE 36

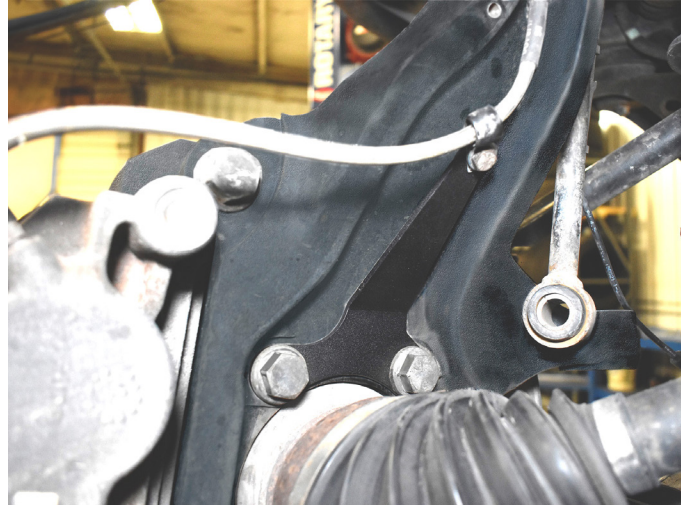


64. There are two threaded holes near the top of the steering knuckle neck, inboard side. Using a provided wire clamp, 1/4" x 5/8" bolt and 1/4" lock washer (BP 590), loosely attach the ABS line to the upper threaded hole on the back side of the steering knuckle (Fig 6). Fasten the brake line to the brake line bracket on the back side of the steering knuckle using 1/4" x 5/8" bolt, 6mm washer, and 1/4"-20 serrated flange nut (Fig 7). The hardware will be tightened once the line slack is set.

FIGURE 37A

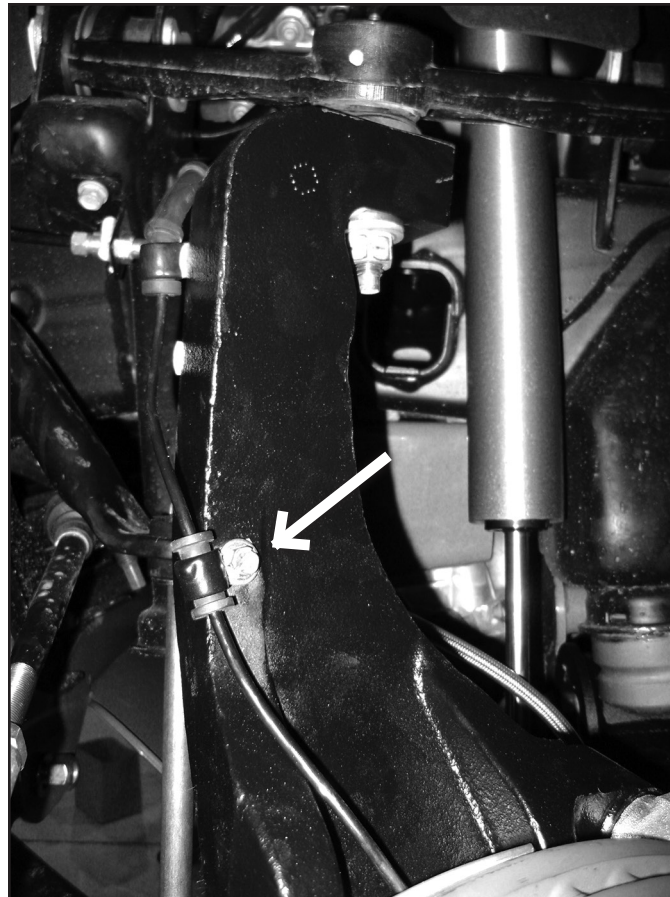


FIGURE 37B



65. On the front side of the steering knuckle there is a small threaded hole. Using a third wire clamp, fasten the ABS wire to the front face of the knuckle with a 1/4" x 3/4" bolt (BP 590). Tighten securely. (Fig 38) Pull the slack out of the line between the clamp and the caliper to provide as much loose line as possible above the clamp then tighten to lock it in place. Adjust the slack in the two other lines, rotating the steering knuckle back and forth as a check, and tighten the upper two clamps to 10 ft-lbs.

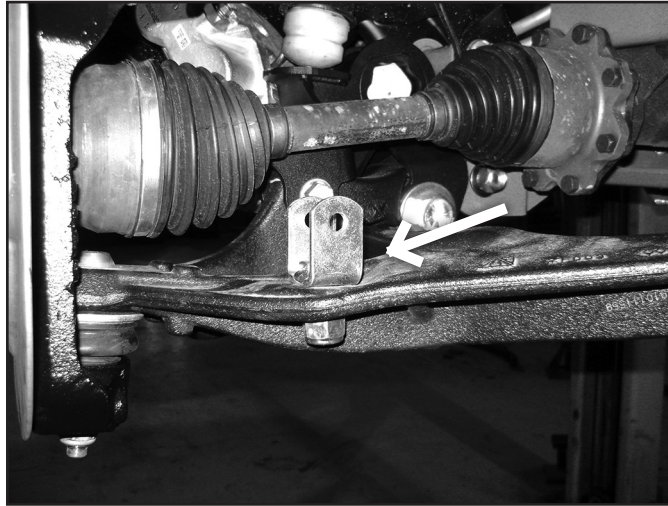
FIGURE 38



66. Locate the new front sway bar links (911109), hourglass bushings (SB58BK) and 0.625" x 1.375" steel sleeves (45313). Lightly grease and install the bushings and sleeves into the sway bar link ends.

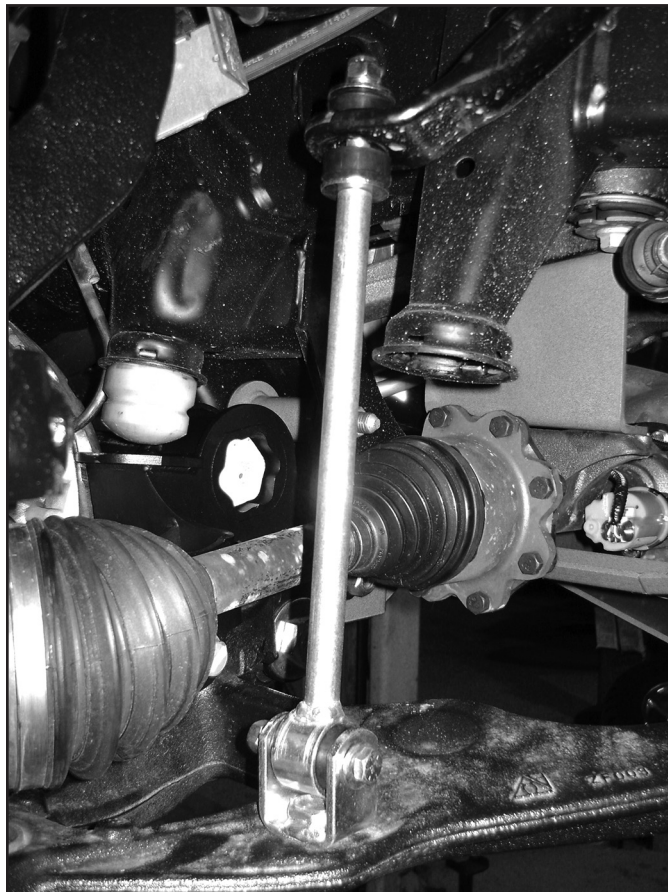
67. Locate the 2 new sway bar link brackets (02129). Install the bracket into the factory sway bar link holes in the lower control arms and fasten with the provided 5/8" nylock nuts and washers (BP582). Torque the nuts to 90 ft-lbs making sure that the link mounting holes are running parallel with the lower control arm mounting bolts. (Fig 39)

FIGURE 39



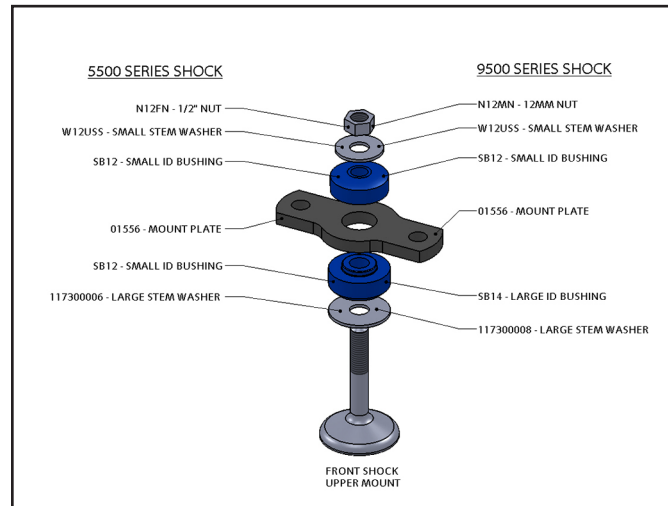
68. Install the new sway bar links into the new brackets and fasten with the provided 3/8" x 2-1/2" bolts, nuts and 3/8" SAE washers (BP 582). Leave bolts loose. Install a provided 7/16" washer followed by a stem bushing. Install the link end into the sway bar end and fasten with a second stem bushing, 7/16" washer and 7/16" nylock nut (BP 582). Tighten the 7/16" nut just until the stem bushings begin to swell. (Fig 40) Torque the 3/8" hardware to 30 ft-lbs.

FIGURE 40



69. Kits installing 2.5 PES shocks, skip to **Step 72**. BDS or Fox 2.0 Performance Series front shocks, follow the diagrams below for assembling the upper shock ends. (Fig 41) A small amount of grease will aid assembly.

FIGURE 41



70. Install the front shocks in the vehicle. Fasten the lower mount with the provided 14mm x 70mm bolt, nut and washers (BP587). Fasten the upper bar pin bracket with 1/2" x 1-1/4" bolts, nuts and 1/2" SAE washers. Torque the upper bolts to 60 ft-lbs. Torque the new lower shock bolt to 90 ft-lbs.
71. **2.5 PES shocks:** Install the side-specific shocks using the Fox included 1/2"-13 x 1-3/4" bolts through the upper bar pin into the frame seat (Fig. 42A). Install the shock reservoir bracket onto the 1/2" bolts and torque nuts to 80 ft-lbs. Fasten the lower mount with the provided 14mm x 70mm bolt, nut and washers (BP587). Torque the new lower shock bolt to 90 ft-lbs. Install the shock reservoir to the bracket with provided clamps, and torque the socket head cap hardware to 60 in-lbs.

Note: Reservoir hose will route forward when installed correctly. Fig. 42B, Driver side shown.

FIGURE 42A

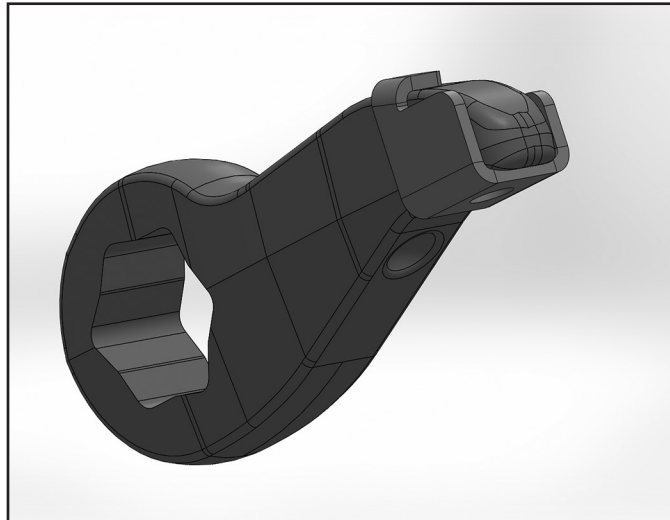


FIGURE 42B



72. With the front shocks installed, torque the front shock bolt at the new torsion bar bracket to 90 ft-lbs. Apply Thread locker to the main 1" bolt threads and torque the bolt to 200 ft-lbs.
73. Attach the tie rod ends to the knuckles. The tie rod end with mount from the top down. Fasten with the original nuts and torque to 44 ft-lbs.
74. Install the torsion bar adjusting bolt retainer onto the end of the torsion key. This will keep the bolt centered on the torsion key when loaded. (Fig 43) It may be necessary to grind the flashing on the parting line of the OEM key casting to get the bolt retainer to stay in place.

FIGURE 43



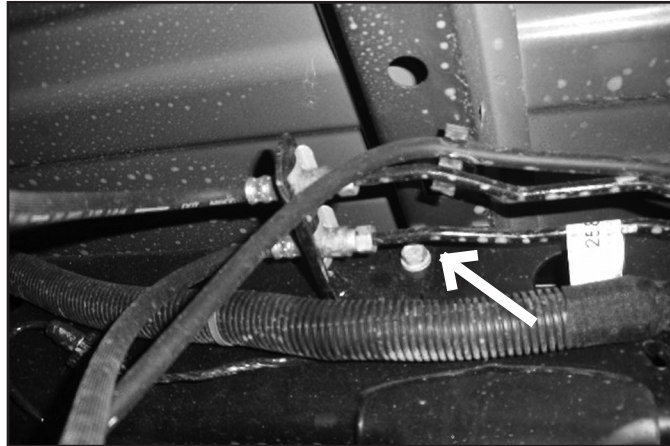
75. Load the torsion bars with the appropriate tool. Reinstall the adjuster bolt/retaining plate assembly. Reset the torsion bar adjuster bolt position to the original height measurement taken at the beginning of the installation. This adjustment will be checked/changed at the end of the installation.
76. Install the front wheels. Torque the lug nuts to 140 ft-lbs. Lower the vehicle to the ground.
77. Bounce the front end to settle the suspension.
78. Torque the lower control arm bolts (4) to 250 ft-lbs.
79. Check all front hardware for proper torque.
80. Properly bleed the entire brake system. Top off fluid. Check all brake lines for proper clearances. Adjust as necessary.

81. Check tire/wheel clearance with the fenders/bumper as well as with the steering knuckle. It is not uncommon to trim the lower plastic valance of the bumper and inner fender shroud slightly to add proper tire clearance while turning.

REAR INSTALLATION

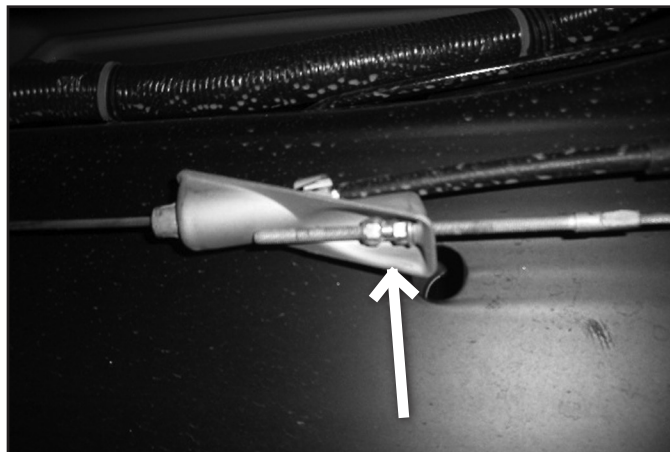
1. Block the front wheels for safety. Raise the rear of the vehicle and support with jack stands under the frame rails, just ahead of the front leaf spring hangers.
2. Remove the wheels.
3. Raise rear of vehicle and support frame with jackstands.
4. Support the rear axle with a hydraulic jack.
5. Disconnect brake line from inside the driver's side frame rail. Save hardware. (Fig R1)

FIGURE R1



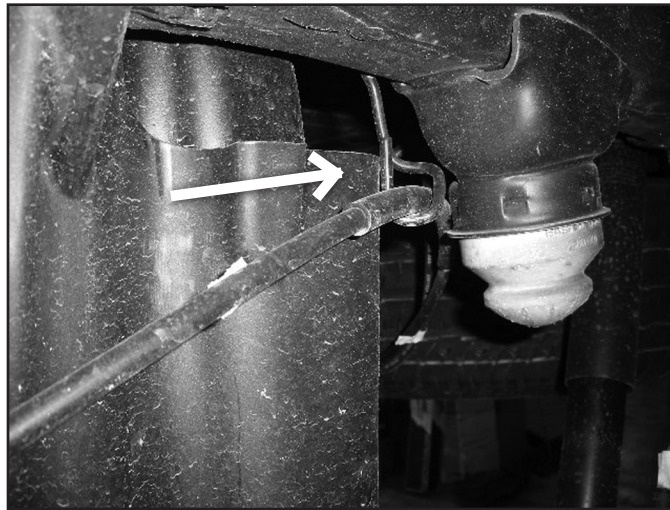
6. Disconnect the emergency brake line from the junction block in front of the rear leaf spring hanger. (Fig R2)

FIGURE R2



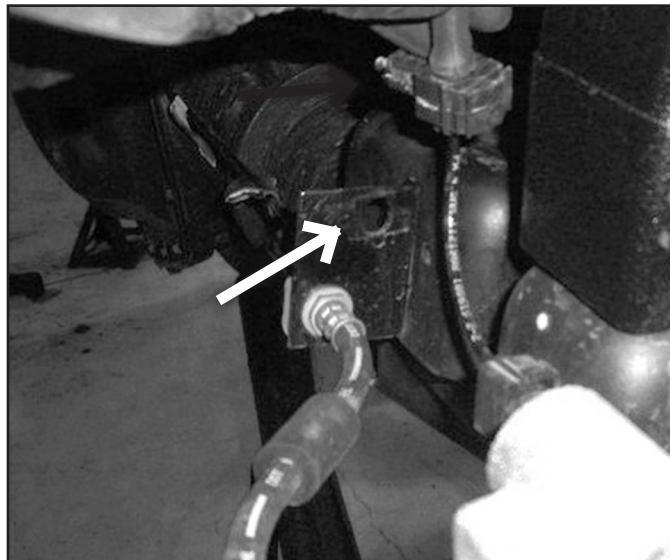
7. Disconnect the E-brake cable bracket from the frame near the rear jounce bumper. Save hardware, it will be reinstalled later. (Fig R3)

FIGURE R3



8. Push the ABS wire clips from the metal tabs just inside of the leaf springs. Remove the plastic clips from the ABS wire.(Fig R4)

FIGURE R4



9. Remove the rear shocks. Save hardware.
10. With the axle well supported, remove the passenger's side u-bolts and lower u-bolt plate. Loosen, but do not remove the u-bolt hardware on the driver's side. This will allow the axle to move more easily and aid in installation.
11. 2", 3", & 4" Rear Box Kits: Lower the axle and install the new block with new u-bolts. Snug but do not tighten at this time. Repeat block installation on opposite side. Skip ahead to step #16.
12. 5" Rear Block Kit Only: Clamp the leaf spring pack with c-clamps and remove the upper u-bolt retaining plate by removing the center pin nut. Reinstall and tighten the center pin nut to 35 ft-lbs. Loosely place the new u-bolt plate (02415) on top of the leaf spring. The plate will use the rear most hole to go around the center pin nut. (Fig R5a, R5b)

FIGURE R5A

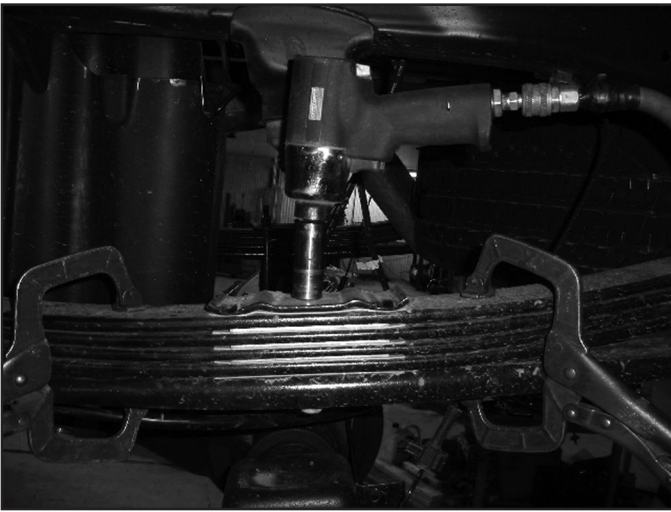
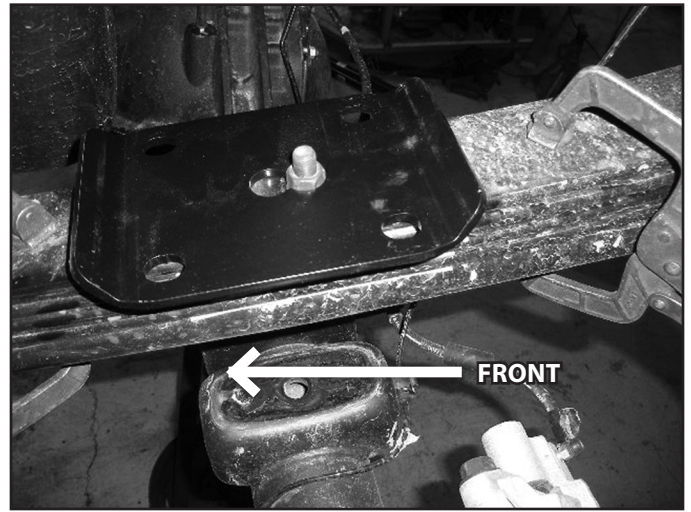
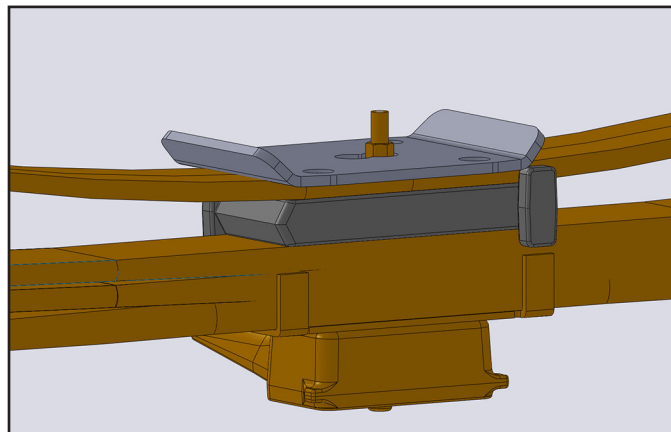


FIGURE R5B



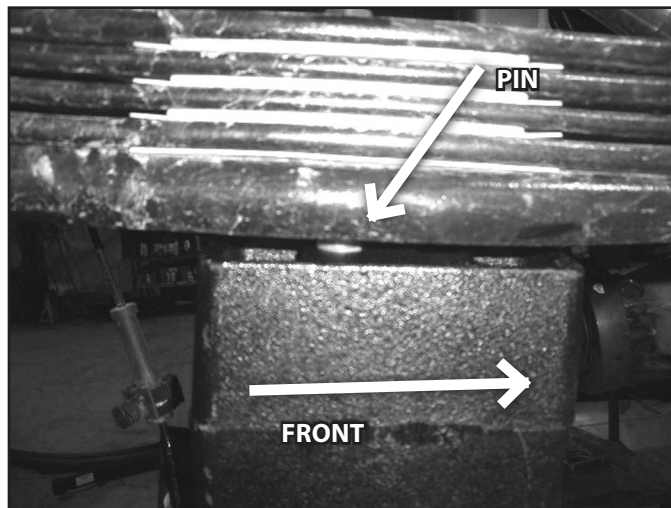
13. 5" Overload options: The Models equipped with overload leaves will need the separation block modified. Trim the anti-rotation tabs from the front side of block on both the inside and outside of the block. Use extreme care near the fuel tank, do not use any method that will create sparks if the block is not removed when modified. A sawzall is highly recommended. (Fig R6)

FIGURE R6



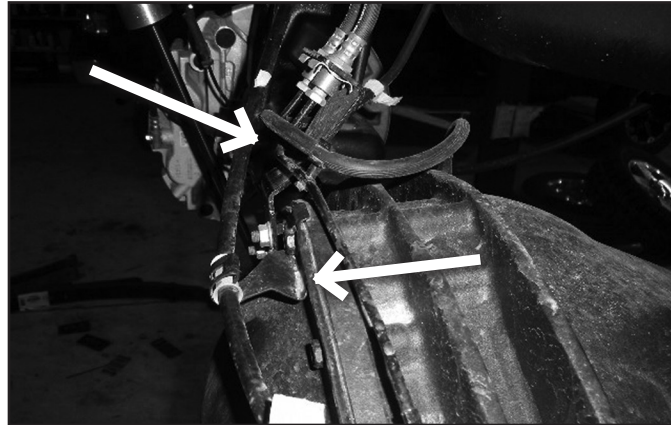
14. Lower the axle to allow the lift block (5FB18) to be installed. The leaf spring pin will go in the REAR hole of the block. (Fig R7)

FIGURE R7



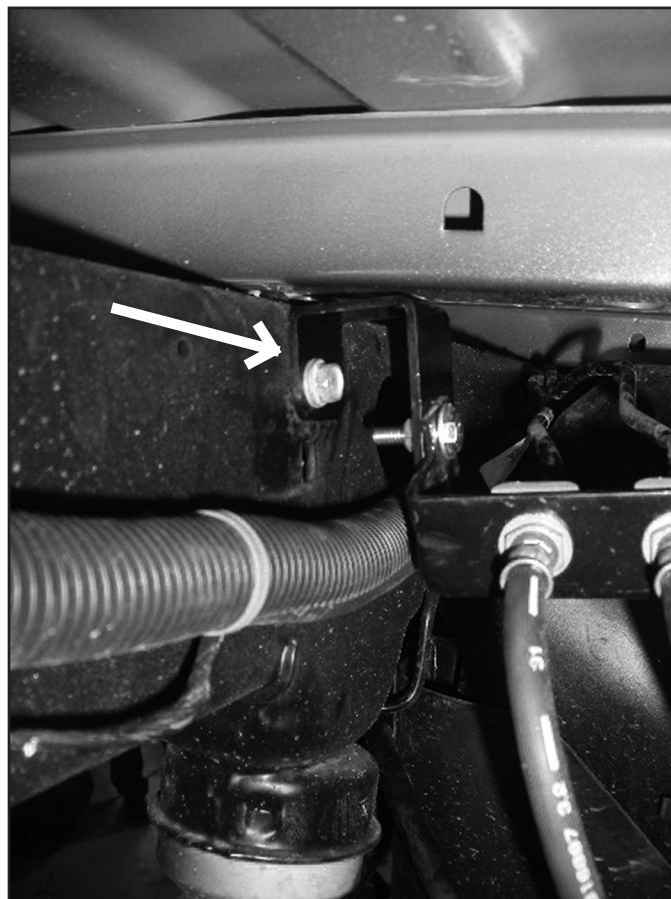
15. Attach axle to springs with new u-bolts (5/8" x 4" x 16"). Run the u-bolts from bottom up and through the new u-bolt plate. Snug the hardware at this time, but do not torque to specification.
16. Repeat block installation for driver's side.
17. Carefully form the brake bracket at the axle to point up at approximately 45 degrees. Bend the e-brake cable bracket at the top of the differential to give enough slack at full droop. (Fig R8) 2" rear box kit - skip ahead to step #25, e-brake cable modification is not needed with 2" rear box kit

FIGURE R8



18. 4", & 5" Rear Block Kits: Install brake line relocation bracket (SBCA) to the frame rail with factory hardware. Use the hole that will allow the bracket to be offset slightly forward.
19. 4", & 5" Rear Block Kits: Attach the brake line to the relocation bracket with 1/4" x 1-1/4" hardware (BP 588). Tighten to 20 ft-lbs. Form the brake lines to clear the fuel tank if necessary. (Fig R9)

FIGURE R9



20. Remove the e-brake cable from the cab mount in front of the leaf spring by removing the plastic retaining clip.

21. Test fit the extension tube into the same hole the plastic ebrake retaining clip was inserted in. Clearance the hole if necessary to fit the extension tube. Once the extension tube is installed insert the e-brake cable through the extension tube. (Fig R10b)

FIGURE R10B

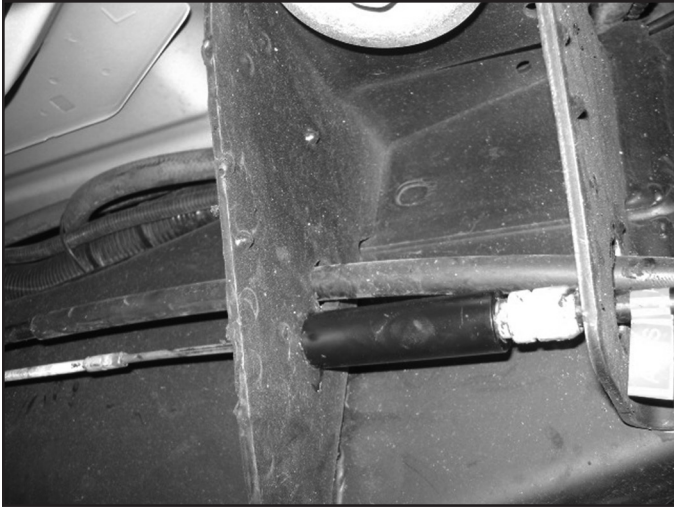
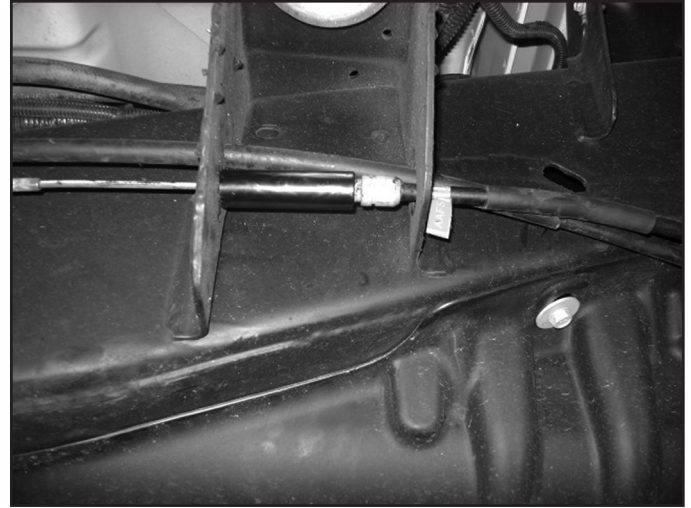


FIGURE R10C



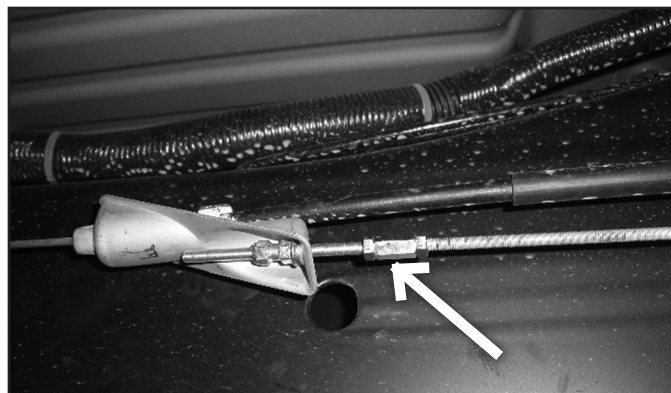
22. Thread on a M6 jam nut and the coupler nut to the e-brake cable (BP 588). Adjust the coupler nut depth to have half of the threads engaged. (Fig R11)

FIGURE R11



23. Attach the M6 threaded extension (SBTE) with jam nut and tighten securely.
24. Reattach the e-brake cable to the junction block with the factory adjuster nut. Tighten until the e-brake cable is at the appropriate tension. Test the e-brake to make sure it functions properly. Adjust tension if necessary. (Fig R12) Check the e-brake cable clearance where it passes through the original hole it was removed from in step 18. If necessary, drill this hole out to 5/8" to provide more clearance and prevent the cable from catching the hole edge. (Fig R10)

FIGURE R12



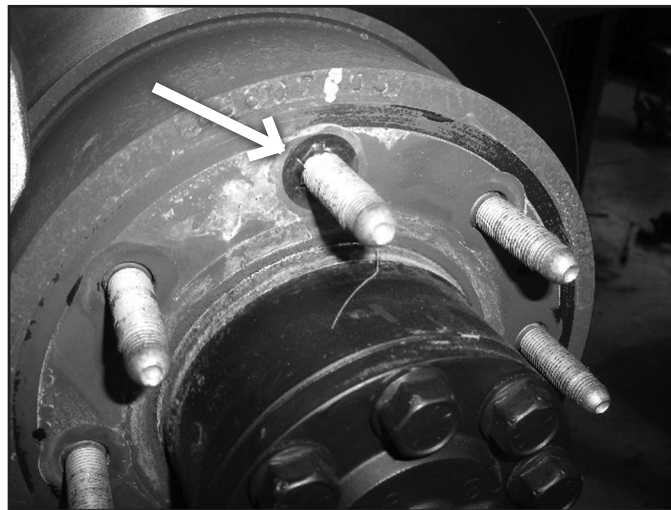
25. Reinstall the E-brake cable bracket near the jounce bumper with factory hardware.
26. Check all cables for adequate slack at full droop, make adjustments if necessary.
27. Install new rear shocks. Tighten hardware to 110 ft-lbs. 3" & 5" rear box kit **SHOCK NOTE:** If installing BDS 5500 series (white) shocks, the passenger's side axle bump stop pad will need to be trimmed for proper clearance of the larger-than-factory shock body as well as relocation of the e-brake cable bracket. Measuring from the bottom inside corner of the pad (near the shock mount), make cut marks 1" up from the bottom and 1-1/4" outward from the inside edge. Also measure back from the front face 3/8". (Fig R13) Cut the square section out with a cut-off tool. Paint exposed metal. The e-brake bracket will need to be relocated up 3/4". Transfer the holes up 3/4" and drill to 7/32". Reattach the bracket with new 1/4" x 1" self threading bolt (bolt pack # 588).

FIGURE R13



28. Remove clips on wheels (Fig R14). Reinstall wheels and lower vehicle to the ground. Torque u-bolts to 125 ft-lbs. Torque lug nuts to 140 ft-lbs.

FIGURE R14



POST-INSTALLATION

1. Check all hardware for proper torque.
2. Reconnect the positive and negative battery cables.

SET FRONT SUSPENSION HEIGHT

3. It is very common for the particular vehicle model to have widely varying starting suspension heights. In order to give a more precise suspension height setting we have provided a Z-height reference. Refer to Figure A

FIGURE A

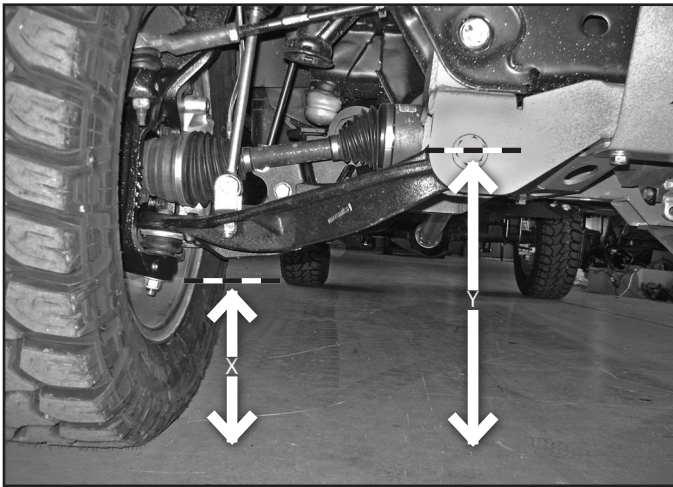
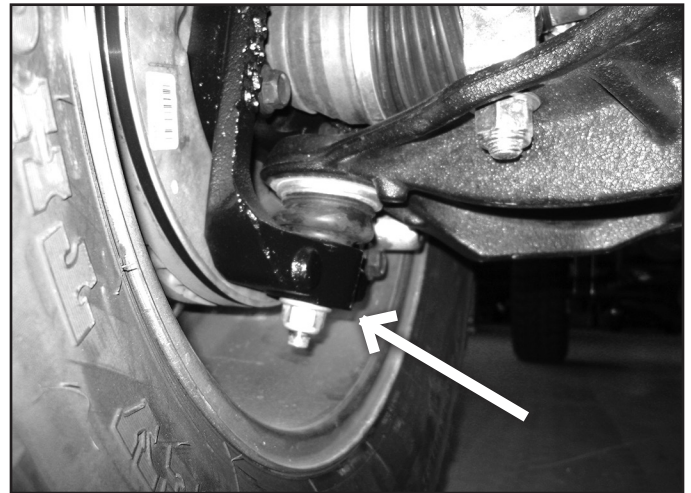


FIGURE B



4. Roll the vehicle forward and back to settle the front suspension. With the vehicle on flat, level ground measure the distance from the floor to the center of the front lower control arm bolt. This is distance 'Y'.
Record here: _____
5. Measure from the floor up to the lowest point on the new steering knuckle, near the ball joint. (Fig B). This is distance 'X'.
Record here: _____
6. 6.5" Kit only: To determine the Z-height use the following equation: $Y-X=Z$. For the intended 6.5" of lift the value for Z should be approximately 7-1/4". If your value for 'Z' is less than 7-1/4" the torsion bars need to be adjusted up (tightened). If your value for 'Z' is more than 7-1/4" the torsion bars need to be adjusted down (loosened). The 'Z' height should not exceed 7-1/4". However, this system can be run at a lower ride height down to a minimum of 5" of lift. At 5" the 'Z' height is 5-3/4". The 'Z' height should not be run below 5-3/4" with the 6.5" system.
7. 4.5" Kit only: To determine the Z-height use the following equation: $Y-X=Z$. For the intended 4.5" of lift the value for Z should be approximately 5-1/4". If your value for 'Z' is less than 5-1/4" the torsion bars need to be adjusted up (tightened). If your value for 'Z' is more than 5-1/4" the torsion bars need to be adjusted down (loosened). The 'Z' height should not exceed 6". However, this system can be run at a lower ride height down to a minimum of 4" of lift. At 4" the 'Z' height is 4-3/4". The 'Z' height should not be run below 4-3/4" with the 4.5" system. The jounce bumpers will ride on the torsion bar relocation bracket, this is the same setup as factory and is part of the factory spring rate.

FINAL CHECK

8. The vehicle will need a complete front end alignment.
9. Check all hardware after 500 miles.
10. Adjust headlights.



WE WANT TO SEE YOUR RIDE!

Grab photos of your BDS-equipped truck in action and send them in for a chance to be featured. Send it in to our Bad Ass Rides customer gallery at bds-suspension.com/bar and post them on the BDS Fan Page on Facebook at facebook.com/BDSSuspensions. Don't forget about your BDS swag! BDS offers t-shirts, hoodies, decals and more available on the BDS website or through your local BDS distributor.

TIME TO HAVE SOME FUN

Thank you for choosing BDS Suspension.

For questions, technical support and warranty issues relating to this BDS Suspension product, please contact your distributor/installer before contacting BDS Suspension directly.