

Rear Block Kit

Ford Super Duty | 2008-2016

Part #: 013518, 013519

Rev.081924



491 W. Garfield Ave., Coldwater, MI 49036 • Phone: 517-279-2135

Web: www.bds-suspension.com • E-mail: tech-bds@ridefox.com

SAFETY WARNING

BDS Suspension Co. recommends this system be installed by a professional technician. In addition to these instructions, professional knowledge of disassembly/ reassembly procedures and post installation checks must be known.

PRE-INSTALLATION NOTES

1. Special literature required: OE Service Manual for model/year of vehicle. Refer to manual for proper disassembly/reassembly procedures of OE and related components.
2. Adhere to recommendations when replacement fasteners, retainers and keepers are called out in the OE manual.
3. Larger rim and tire combinations may increase leverage on suspension, steering, and related components. When selecting combinations larger than OE, consider the additional stress you could be inducing on the OE and related components.
4. Post suspension system vehicles may experience drive line vibrations. Angles may require tuning, slider on shaft may require replacement, shafts may need to be lengthened or trued, and U-joints may need to be replaced.
5. Secure and properly block vehicle prior to installation of BDS Suspension components. Always wear safety glasses when using power tools.
6. If installation is to be performed without a hoist, BDS Suspension Co. recommends rear alterations first.
7. Due to payload options and initial ride height variances, the amount of lift is a base figure. Final ride height dimensions may vary in accordance to original vehicle attitude. Always measure the attitude prior to beginning installation.

POST-INSTALLATION WARNINGS

1. Check all fasteners for proper torque. Check to ensure for adequate clearance between all rotating, mobile, fixed, and heated members. Verify clearance between exhaust and brake lines, fuel lines, fuel tank, floor boards and wiring harness. Check steering gear for clearance. Test and inspect brake system.
2. Perform steering sweep to ensure front brake hoses have adequate slack and do not contact any rotating, mobile or heated members. Inspect rear brake hoses at full extension for adequate slack. Failure to perform hose check/ replacement may result in component failure. Longer replacement hoses, if needed can be purchased from a local parts supplier.
3. Perform head light check and adjustment.

Box Kit		
Part #	Qty	Description
02414	2	5" Rear Block
02415	2	Spring Plate
343581812RB	4	U-Bolt (013518 only)
343581500RB	4	U-Bolt (013519 only)
N34FLG-B	8	U-Bolt Flange Nut

4. Re-torque all fasteners after 500 miles. Always inspect fasteners and components during routine servicing.

INSTALLATION INSTRUCTIONS

5. Park on a clean, flat surface and block the front wheels for safety.
6. Raise the rear of the vehicle and support with jack stands under the frame rails just ahead of the spring hangers.
7. Remove the wheels.
8. Support the axle with a hydraulic jack.
9. Remove the OE shocks. Retain all mounting hardware
10. Remove the ABS wires from the axle bracket. Remove brakeline retaining clips holding brakeline hardlines in place. Pull the brakelines through the mounting bracket and trim a slot to remove them from the bracket. Use extra caution to not damage the brakelines. (Fig 1).

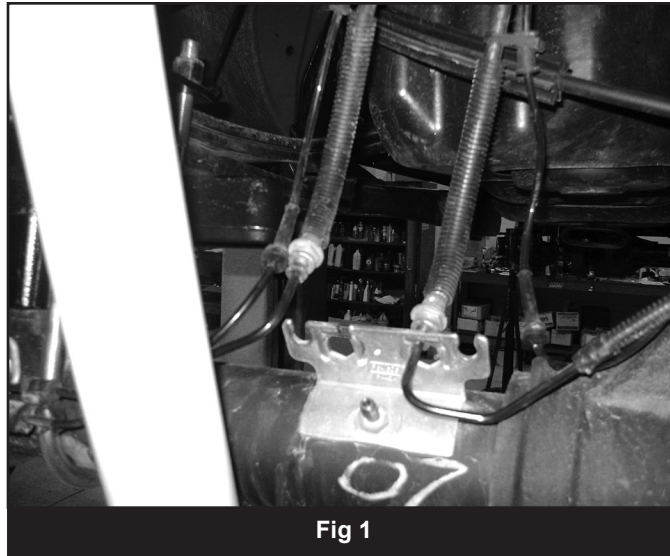

Fig 1

11. Disconnect the passenger's side spring u-bolts. Using two C-Clamps, clamp the leaf spring on each side of the top u-bolt plate. (Fig 1) Remove the center pin nut and remove the u-bolt plate. Reinstall the center pin nut and torque to 40 ft-lbs. The u-bolts, top plate and bottom plate will not be reused.

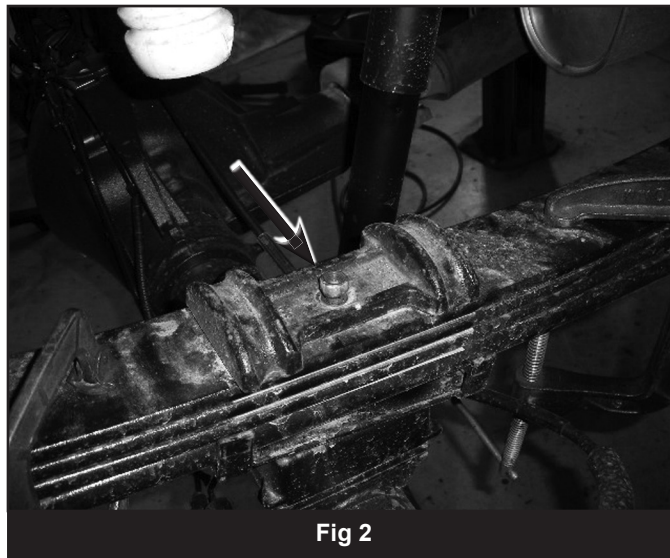

Fig 2

12. Remove the factory lift block. It will not be reused.
13. Lower the axle enough to place the provided 5" lift block between the axle and the leaf spring. Position the block so the bump stop wing faces inward. Make note that there are two center pin holes in the new blocks. The center pin will need to be aligned to the rear hole. This will ensure the axle moves slightly forward and the wheels are aligned properly in the wheel well.
14. F-350 models with overload leaf, the spacer block to the overload leaf needs to be modified. Remove the front tabs (inside and outside) from the casting to give clearance to the new u-bolt. Use a sawzall to remove tabs. Use extreme caution to not create any sparks near the fuel tank. (Fig 2)

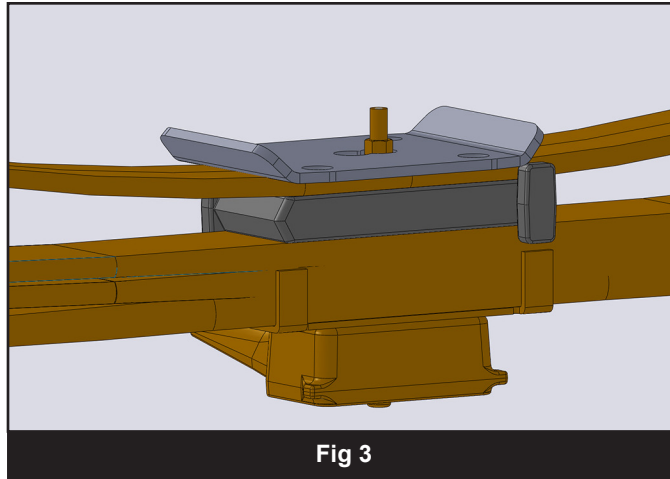

Fig 3

15. Raise the axle to engage the block spring alignment pins. Be certain the leaf center pin aligns with the REAR hole in the new lift block. Position the new u-bolt plate on the top of the spring over the center pin nut. Position the plate so the bolt pattern is shifted forward on the spring. (Fig 3) Fasten the entire assembly with the provided u-bolts, and flanged nuts. Snug but do not torque the u-bolts at this time.

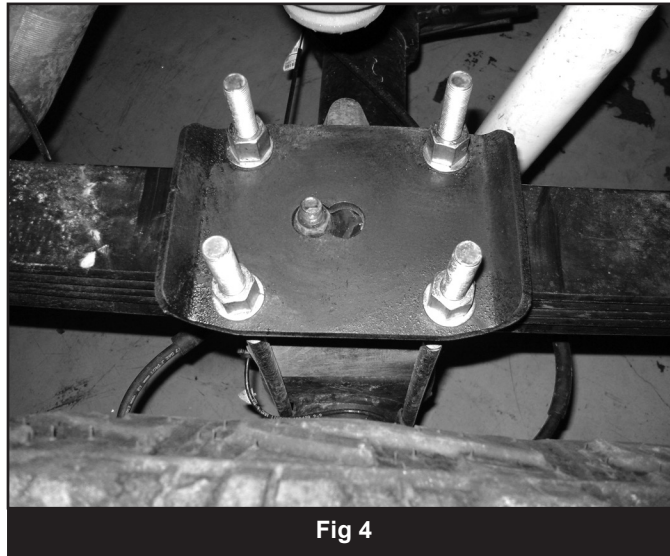

Fig 4

16. Repeat block installation of the driver's side. Take care not to over extend the brake lines. **Note:** The parking brake cable bracket will need to be removed from the spring center pin. (Fig 4)

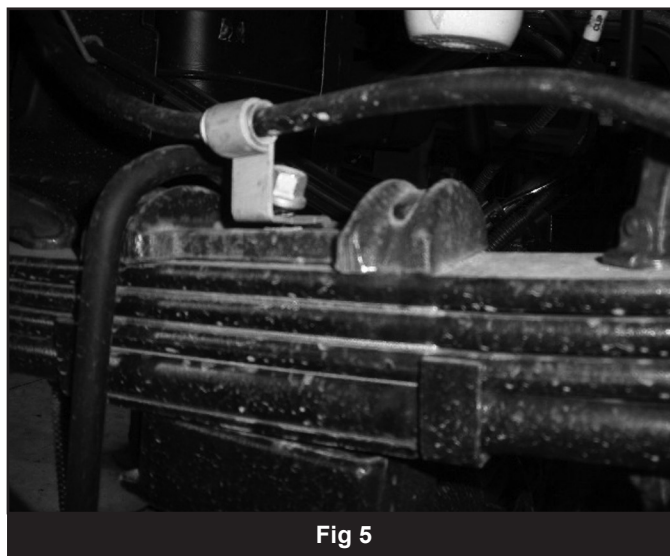
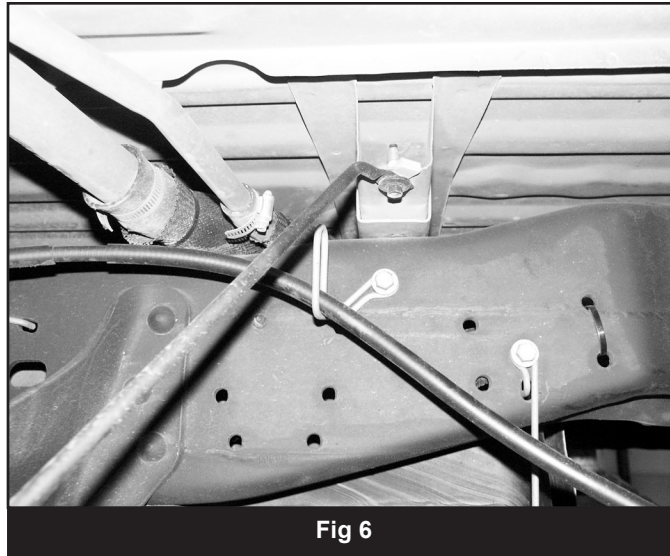
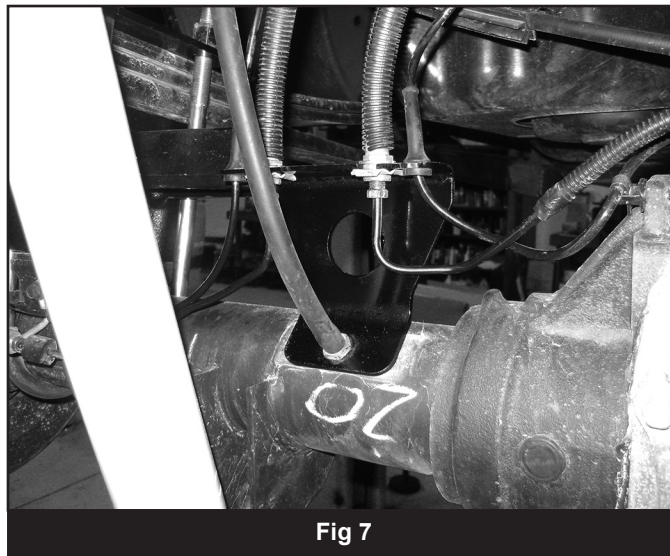

Fig 5

17. Reattach the parking brake cable bracket to the driver's side center pin with the original nut. If more parking brake cable slack is needed, remove the cable from the rear-most retaining bracket on the frame. (Fig 5)



18. Install the new shocks with the original mounting hardware.
19. (4" & 6" Lifts Only) Install new brakeline relocation bracket on the axle with stock breather tube stud. Install brakelines with original clips into the new bracket. Attach ABS wires into the new bracket. Attach diff breather line to the axle breather stud. (Fig 7).



20. Install wheels and lower the vehicle to the ground.
21. With the weight of the vehicle on the axle, torque the u-bolts to 113 ft-lbs.
22. Check all hardware for proper torque.
23. Check hardware after 500 miles.