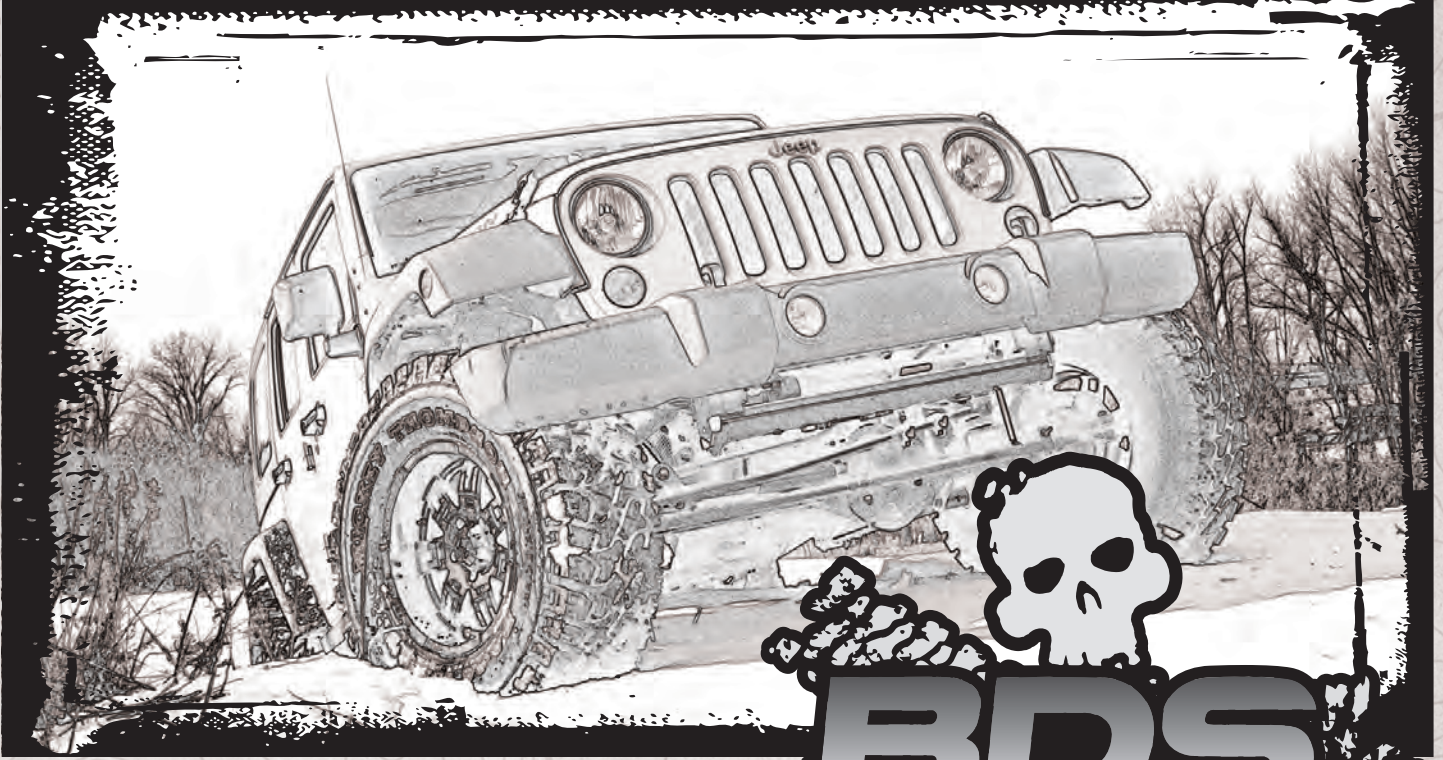


INSTALLATION GUIDE



Part#: 014493-014690

HARDCORE LIMITED LIFETIME WARRANTY

Long Arm Suspension System

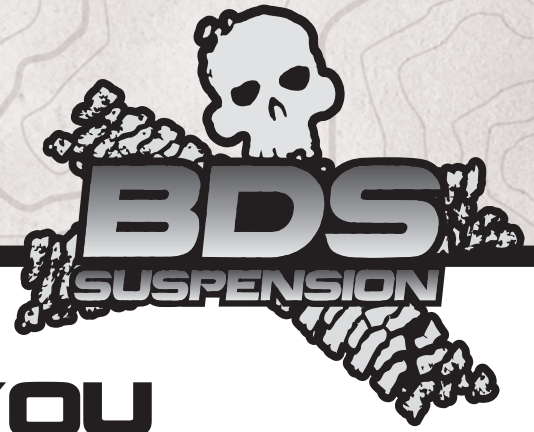
Jeep Wrangler JK 4WD | 2007-2016

Rev. 021206

491 W. Garfield Ave., Coldwater, MI 49036 • Phone: 517-279-2135

Web/live chat: www.bds-suspension.com • E-mail: tech-bds@sporttruckusainc.com

Read And Understand All Instructions And Warnings Prior To Installation Of System And Operation Of Vehicle.



THANK YOU

Your truck is about to be fitted with the best suspension system on the market today. That means you will be driving the baddest looking truck in the neighborhood, and you'll have the warranty to ensure that it stays that way for years to come.

Thank you for choosing BDS Suspension!

BEFORE YOU START

BDS Suspension Co. recommends this system be installed by a professional technician. In addition to these instructions, professional knowledge of disassembly/ reassembly procedures and post installation checks must be known.

FOR YOUR SAFETY

Certain BDS Suspension products are intended to improve off-road performance. Modifying your vehicle for off-road use may result in the vehicle handling differently than a factory equipped vehicle. Extreme care must be used to prevent loss of control or vehicle rollover. Failure to drive your modified vehicle safely may result in serious injury or death. BDS Suspension Co. does not recommend the combined use of suspension lifts, body lifts, or other lifting devices. You should never operate your modified vehicle under the influence of alcohol or drugs. Always drive your modified vehicle at reduced speeds to ensure your ability to control your vehicle under all driving conditions. Always wear your seat belt.

BEFORE INSTALLATION

- Special literature required: OE Service Manual for model/year of vehicle. Refer to manual for proper disassembly/reassembly procedures of OE and related components.
- Adhere to recommendations when replacement fasteners, retainers and keepers are called out in the OE manual.
- Larger rim and tire combinations may increase leverage on suspension, steering, and related components. When selecting combinations larger than OE, consider the additional stress you could be inducing on the OE and related components.
- Post suspension system vehicles may experience drive line vibrations. Angles may require tuning, slider on shaft may require replacement, shafts may need to be lengthened or trued, and U-joints may need to be replaced.
- Secure and properly block vehicle prior to installation of BDS Suspension components. Always wear safety glasses when using power tools.
- If installation is to be performed without a hoist, BDS Suspension Co. recommends rear alterations first.
- Due to payload options and initial ride height variances, the amount of lift is a base figure. Final ride height dimensions may vary in accordance to original vehicle attitude. Always measure the attitude prior to beginning installation.



Visit 560plus.com for more information.

TIRES AND WHEELS

37x12.50 with 16 x 8 and 4.5" backspacing



BEFORE YOU DRIVE

Check all fasteners for proper torque. Check to ensure for adequate clearance between all rotating, mobile, fixed, and heated members. Verify clearance between exhaust and brake lines, fuel lines, fuel tank, floor boards and wiring harness. Check steering gear for clearance. Test and inspect brake system.

Perform steering sweep to ensure front brake hoses have adequate slack and do not contact any rotating, mobile or heated members. Inspect rear brake hoses at full extension for adequate slack. Failure to perform hose check/ replacement may result in component failure. Longer replacement hoses, if needed can be purchased from a local parts supplier.

Perform head light check and adjustment.

Re-torque all fasteners after 500 miles. Always inspect fasteners and components during routine servicing.

CONTENTS OF YOUR KIT

014493/014690 Box Kit

Part #	Qty	Description
084402R	1	Dropped Pitman Arm
099002	2	8-3/8" Cable Tie Tree
099000	2	11.5" Nylon Cable Tie
342701	1	Loctite - 1ml
01997	2	Rear Coil Mount (014690 only)

FRONT BUMP STOPS

3396	2	Front Bump Stop Spacer
438	1	Bolt Pack
	2	3/8"-16 x 3-1/2" bolt
	2	3/8" USS flat washer
	1	3/8"-16 x 1" self-tapping bolt

FRONT CONTROL ARM MOUNTS

760	1	Front LCA Mount Bolt Pack
	2	1/2"-13 x 1-1/4" bolt grade 8
	2	1/2"-13 x 1-1/2" bolt grade 8
	2	1/2"-13 prevailing torque nut
	6	1/2" SAE flat washer
	2	9/16"-12 x 4" bolt grade 8
	2	9/16"-12 prevailing torque nut
	4	9/16" SAE flat washer
761	1	Front UCA Mount Bolt Pack
	2	12mm-1.75 x 90mm
	2	12mm-1.75 x 100mm
	4	12mm-1.75 prevailing torque nut
	8	1/2" SAE flat washer
	4	7/16"-14 x 1-1/4" bolt
	4	7/16"-14 prevailing torque nut
	8	3/8" USS flat washer thru-hardened
92	2	.75 x 0.134 x 1.98 DOM Sleeve
01998	2	Jeep JK Long Arm Nut Tab
01983B	1	Front LCA Mount - DS
01984B	1	Front LCA Mount - PS
01900	2	Upper Control Arm Bracket

FRONT TRACK BAR BRACKET

01964B	1	Front Track Bar Bracket
01942	1	Track Bar Gusset - Lower
01943	1	Track Bar Gusset - Upper
69	1	.75 x .083 x 1.375 Sleeve
562	1	Bolt Pack
	2	7/16"-14 x 1" bolt - grade 8
	4	7/16" SAE thru-hardened washer
	2	7/16"-14 Prevailing torque nut
	1	9/16"-12 x 3" bolt - grade 8
	2	9/16" SAE thru-hardened washer
	1	9/16"-12 Prevailing torque nut

014493/014690 Box Kit

	1	1/2"-13 x 1" bolt grade 8
	1	1/2"-13 heavy square nut grade 5
	1	1/2" SAE flat washer thru-hardened

REAR BUMP STOPS

01928B	2	Bump Stop Extension (014483 only)
01999B	2	Bump Stop Spacer Brkt (014690 only)
763	1	Bolt Pack - Rear Bump Stops
	2	5/16"-18 x 1-1/4" bolt grade 8
	2	5/16"-18 x 7/8" bolt grade 8
	4	5/16"-18 prevailing torque nut
	8	5/16" SAE flat washer
	2	1/4"-20 x 1" self tapping bolt

REAR CONTROL ARM MOUNTS

01985B	1	Rear Long Arm Bracket - DS
01986B	1	Rear Long Arm Bracket - PS
01797	3	GM 2in Lift Bolt Tab
27031	1	1/2in Bolt Fish Wire
95105A169	4	1/2-13 Rivet Nut (.063-.200 thk)
95105A170	2	1/2-13 Rivet Nut (over .200 thk)
762	1	Bolt Pack
	4	9/16"-12 x 4" bolt grade 8
	4	9/16"-12 prevailing torque nut
	8	9/16" SAE flat washer thru-hardened
	1	9/16"-18 high nut
	4	1/2"-13 x 1-1/2" bolt grade 8
	3	1/2"-13 x 2-1/2" bolt grade 8
	3	1/2"-13 prevailing torque nut
	10	1/2" SAE flat washer thru hardened
	1	1/2" external tooth lock washer
	2	7/16"-14 x 1-1/4" bolt grade 8
	2	7/16"-14 prevailing torque nut
	4	3/8" USS flat washer thru-hardened
	1	12mm-1.50 x 35mm bolt - class 10.9
	1	12mm flat washer
	2	12mm ID x 1-1/2" OD thick washer

REAR SWAY BAR DROP (014690 ONLY)

01976	1	Sway Bar Drop Bracket- DS
01977	1	Sway Bar Drop Bracket- PS
759	1	Bolt Pack - Sway Bar Drop
	4	7/16"-14 x 1" bolt grade 5
	4	7/16"-14 prevailing torque nut
	8	7/16" SAE flat washer
	2	3/8"-16 x 1" self-tapping bolt

014493/014690 Box Kit**REAR TRACK BAR BRACKET**

01967B	1	4" Track Bar Bracketn (014443 only)
01987B	1	6" Track Bar Bracket (014690 only)
54587	1	.750 x .090 x 1.575 Sleeve
563	1	Bolt Pack
	1	9/16"-12 x 3" Bolt - grade 8
	1	9/16"-12 x 3-1/2" Bolt - grade 8
	4	9/16" SAE thru-hardened washer
	2	9/16"-12 Prevailing torque nut
	1	3/8"-16 x 1-1/4" bolt - grade 8
	2	3/8" SAE thru-hardened washer
	1	3/8"-16 Prevailing torque nut

REAR SWAY BAR LINKS (014493 ONLY)

92025	2	Sway Bar Extension
SB58BK	4	5/8 ID Hourglass Bushing
62147	4	.625 x .075 x 1.375 Sleeve
758	1	Bolt Pack
	2	12mm-1.75 x 60mm bolt class 10.9
	2	12mm-1.75 prevailing torque nut
	4	1/2" SAE washer

FRONT BRAKE LINES

22542	1	Front Brake Line - DS (014483 only)
22543	1	Front Brake Line - PS (014483 only)
22540	1	Front Brake Line - DS (014690 only)
22541	1	Front Brake Line - PS (014690 only)
CCW-03-050	4	3/8 Brake Line Crush Washer
B06103C	2	Brake Line L-Bracket
5188	2	Snap In Brake Line Clip

REAR BRAKE LINES

22540	1	Rear Brake Line - DS
22541	1	Rear Brake Line - PS
CCW-03-050	4	3/8 Brake Line Crush Washer
5188	2	Snap In Brake Line Clip
B06103C	2	Brake Line L-Bracket
22540	1	Rear Brake Line - DS
22541	1	Rear Brake Line - PS
CCW-03-050	4	3/8 Brake Line Crush Washer
5188	2	Snap In Brake Line Clip
B06103C	2	Brake Line L-Bracket

014691 Box Kit

Part #	Qty	Description
A192	2	Adjustable Flex Front LCA
A193	2	Adjustable Flex Front UCA

014689 Box Kit

Part #	Qty	Description
A194	2	Adjustable Flex Rear LCA
A195	2	Adjustable Flex Rear UCA

124603 Box Kit Standard Kits

Part #	Qty	Description
A169	2	Disconnect Assembly (124603 only)
01302	2	Disconnect Stud
01316	2	13.5in Lanyard
46	2	.750 x .120 x 1.450 Rolled Sleeve
912	1	Bolt Pack
	2	1/2"-13 x 3" bolt grade 5
	2	1/2"-13 prevailing torque nut
	8	1/2" SAE flat washer
	2	1/2"-20 prevailing torque nut
	2	1-3/8" OD x 1/2" ID Thk flat washer

124321 Box Kit Rubicon Kits

Part #	Qty	Description
911111	2	Sway Bar Link (124321 only)
46	4	.750 x .120 x 1.450 Sleeve
SB34BK	4	3/4 ID Hourglass Bushing
B12X3G5	2	1/2 x 13 x 3 Grade 5 Bolt
N12PT	2	1/2 x 13 Prevailing Torque Nut
W12S	4	1/2in Washer

TROUBLESHOOTING INFORMATION FOR YOUR VEHICLE

1. Will not fit 2WD models.
2. The front and rear driveshafts are maxed out at full droop. The front driveshaft boot can contact the transmission pan at extreme articulation on some models. Replacement of the front and rear driveshafts is recommended.
3. Exhaust modification may be required.

INSTALLATION INSTRUCTIONS

INSTALLATION INSTRUCTIONS

1. Park the vehicle on a clean, flat surface and block the rear wheels for safety.
2. Welding is required in the kit, disconnect the battery at this time.
3. Disconnect the front track bar from the axle mount (Fig 1). Retain mounting hardware.

SPECIAL TOOLS

Pitman arm puller
Welder

FIGURE 1



4. Raise the front of the vehicle and support with jack stands under the frame rails. These stands may need to be moved during the installation to allow access/clearance to certain components.
5. Remove the front wheels.
6. Support the front axle with a hydraulic jack.
7. Disconnect the front sway bar links from the axle and sway bar. Discard links and save hardware.
Disconnect the track bar from the frame and remove from the vehicle. Retain the track bar and hardware.
8. Disconnect the steering drag link from the pitman arm (Fig 2). Remove the tie rod end nut and dislodge the tie rod end from the pitman arm with the appropriate puller or pickle fork, do not damage the rubber boot. Retain tie rod end nut.

FIGURE 2



9. Make indexing marks on the pitman arm to indicate the position relative to the splines. Remove pitman arm from steering box with appropriate puller. Retain hardware.
10. Transfer indexing marks on pitman arm to the new pitman arm. Install new pitman arm (084402R) with OE hardware. Torque to 185 ft-lbs.
11. Remove the front axle breather hose from the driver's side front shock tower (Fig 3). Leave the metal retaining clip on the hose. It will be reattached later at a lower position on the shock tower to compensate for the increase suspension travel.
12. Disconnect the ABS wire from the brake line and retaining bracket on the knuckle (Fig 4).

FIGURE 3



FIGURE 4



13. Disconnect the factory front brake line from the hard line at the frame and caliper on the axle. Have a container ready to catch the fluid. Remove bolt mounting the brake line to the frame and (and axle on 2010+ models), the brake line will be fully remove once the shocks are disconnected. Retain the lower banjo bolt and the frame bracket mounting bolt.
14. Install the provided brake line mounting bracket (B06103C) to the frame using the original mounting hole and bolt. Leave hardware loose.
15. Attach the new brake line (22542-drv, 22543-pass, this is the shorter set of brake lines) to the caliper with the original banjo bolt and two new crush washers (CCW-03-050). Place a crush washer on each side of the fitting. Torque banjo bolt to 30 ft-lbs.



Tip

Make sure that the old crush washers are removed from the bolt and caliper. When installed in the correct position the brake line fitting will point up and slightly away from the caliper.

16. Run the upper end of the new brake line through the frame bracket and fasten to the hard line securely. Fasten the line to the bracket with the provided clip (5188). Torque the bracket mounting bolt to 10 ft-lbs.

17. With the front axle supported with a jack, remove the lower shock mounting bolts. Lower the axle and remove the coil springs. Raise the axle and reattach the shocks to the axle. Leave hardware loose.



Tip Leaving the shock attached at this point will aid in supporting the axle during the installation of the new control arms.

18. Position the provided "L" shaped front track bar gusset (01943) between the inside edge of the factory track bar mount and the driver's side UCA axle mount. Position the bracket so it is flush to the OE mount and the front edge is square to the front face of the OE mount (Fig 5). Note the areas to be welded and remove the gusset. Remove the paint from the areas to be welded, reposition the gusset and weld in place. Be sure to weld the gusset to the OE mount along all 3 edges, the gusset to the axle and the gusset to the UCA mount.

FIGURE 5

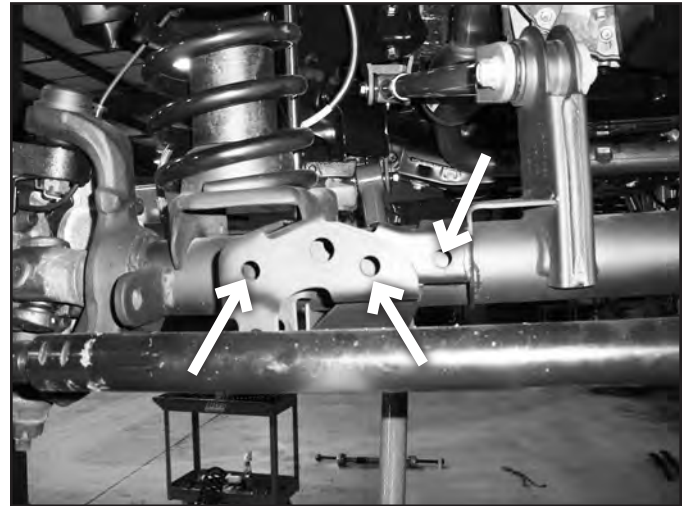


19. Position the new flat track bar mount gusset plate (01942) so that it spans the two passenger's LCA mounting plates and the narrow end butts up against the bottom side of the OE track bar mount. Note the areas to be welded, remove the gusset and remove paint from the areas to be welded (Fig 6). Reposition the gusset and weld in place. Allow all welds to cool and paint the entire area where there is any bare metal.
20. Drill the three small existing holes in the OE track bar mount to 1/2" (Fig 7).

FIGURE 6



FIGURE 7



21. Install new front track bar bracket (01964) with the provided crush sleeve (69) to the OE mount with the provided 9/16" x 3" bolt, nut and washers (BP 562). Fasten the bracket with two 7/16" x 1" bolts, nuts and washers in the two front face holes and a 1/2" x 1" bolt and washer in the remaining hole (BP 562). The 1/2" bolt will use the provided square nut, a wrench is not needed to hold the nut (Fig 8). Use Loctite on the 1/2" bolt threads. After all the hardware is installed torque the 9/16" hardware to 100 ft-lbs, the 1/2" hardware to 60 ft-lbs and the 7/16" hardware to 50 ft-lbs.
22. Remove the three bolts (4 on some models) mounting the transmission skid plate to the frame rails and transmission crossmember (Fig 9). This skid plate will not be reused. Retain the mounting hardware.

FIGURE 8

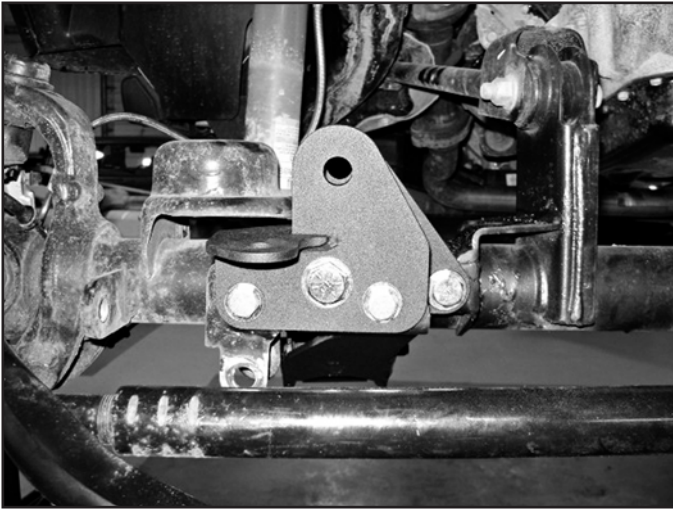
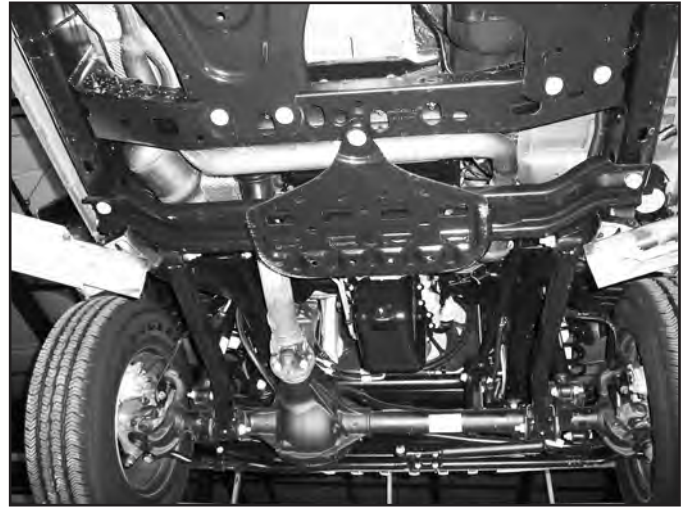
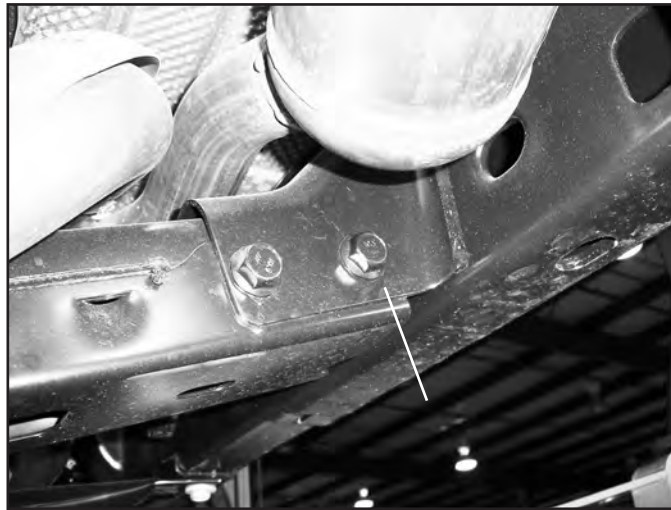


FIGURE 9



23. Remove the outer transmission crossmember mounting bolt on each end of the crossmember (Fig 10). Retain the mounting hardware.

FIGURE 10



24. Position the provided front LCA mount (01983B-driv, 01984B-pass) up to the frame rail and against the front face of the transmission crossmember (Fig 11). Loosely fasten the bracket to the frame with the OE skid plate bolt and to the crossmember with the OE crossmember hardware.
25. With the bracket positioned flush to all the mounting surfaces, mark the outer mounting hole to be drilled in the frame (Fig 12). Remove the bracket and drill a 1/2" hole at the mark.

FIGURE 11

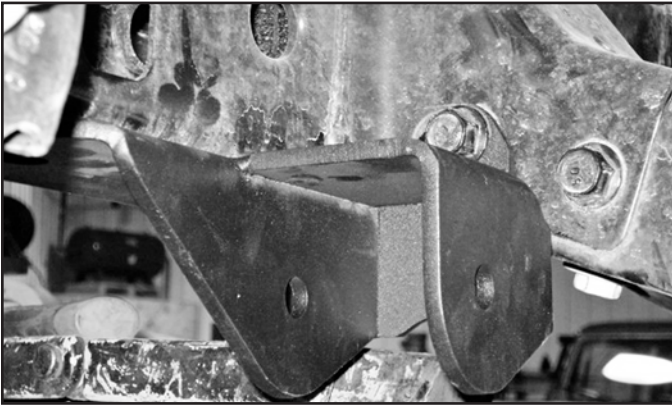
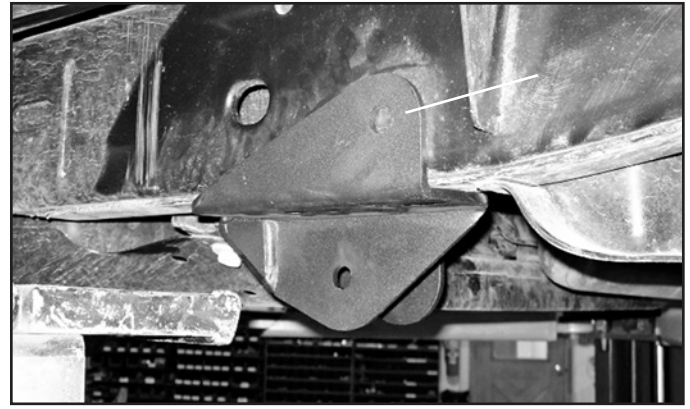
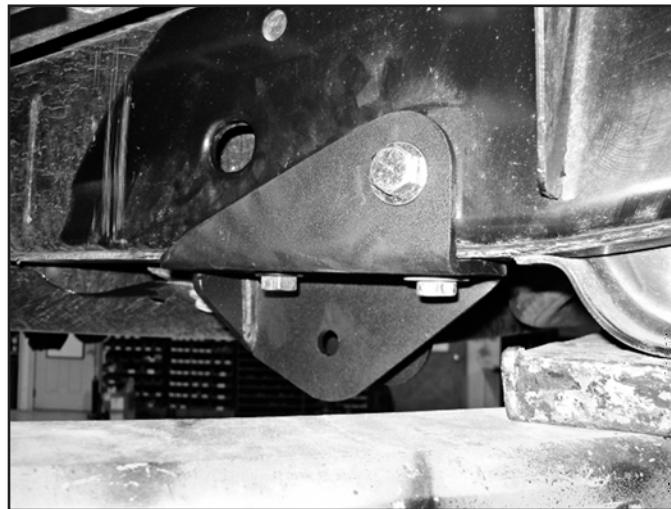


FIGURE 12



26. After the mounting hole is drilled in the frame, reattach the LCA mount to the frame with the OE crossmember bolt and a $\frac{1}{2}$ " x 1- $\frac{1}{4}$ " bolt, nut and $\frac{1}{2}$ " SAE washers (BP 760) through the newly drilled hole. Install a $\frac{1}{2}$ " x 1- $\frac{1}{2}$ " bolt and $\frac{1}{2}$ " SAE washer (BP 760) up through the rear-most hole in the bracket into the existing frame hole and fasten with the provided nut tab (01998). Loosely install the OE skid plate bolt.
27. With all of the LCA mount hardware installed, torque fasteners to 65 ft-lbs. The OE skid plate bolt should be the last bolt to be tightened (Fig 13).

FIGURE 13

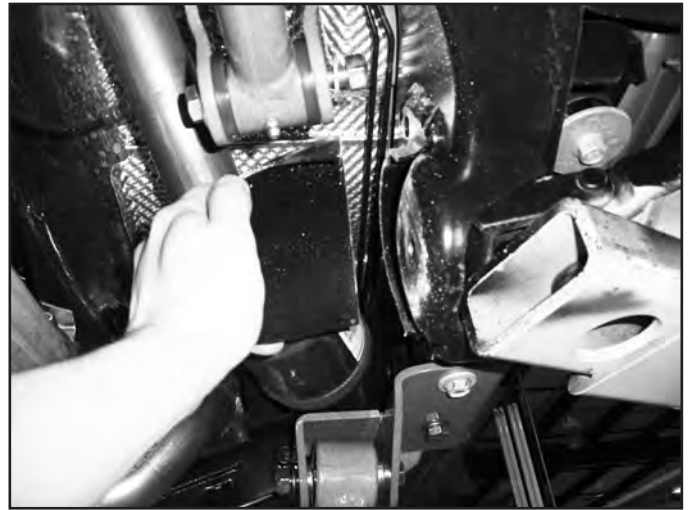


28. With a jack supporting the front axle, remove the factory lower control arms.
29. The inside portion of the factory frame LCA mount must be cut off to provide clearance for the new arms under suspension compression. Using a reciprocating saw, cut the inside of the pocket off flush with the outer pocket mounting surface (Fig 14A/B). The outer portion of the OE mount can stay intact. Deburr and paint any exposed metal to prevent rust.

FIGURE 14A

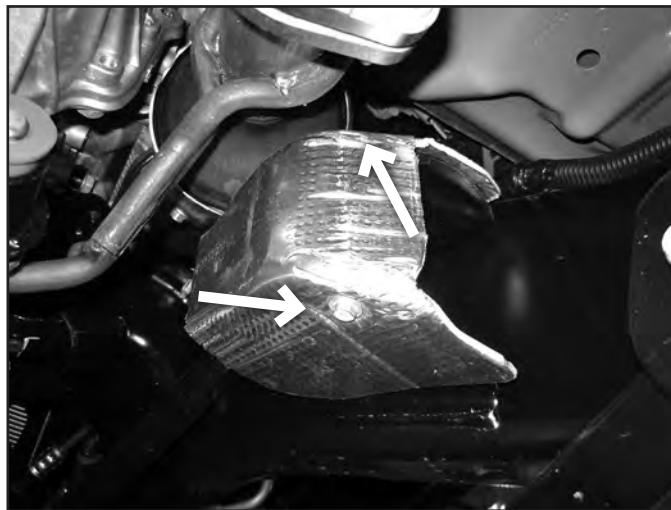


FIGURE 14B



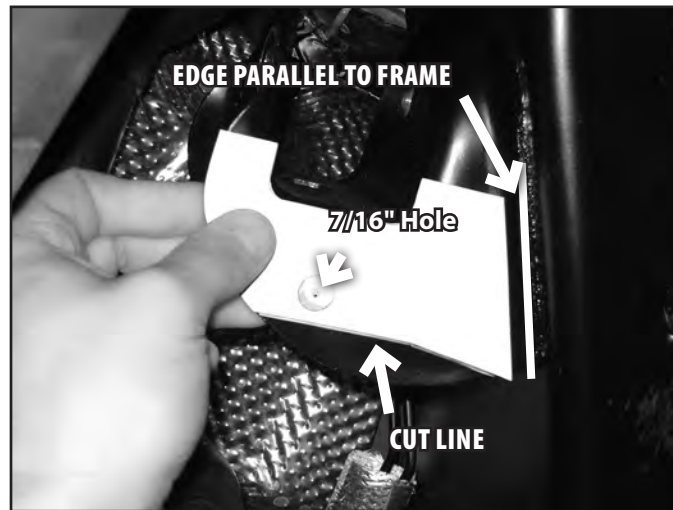
30. Cut the passenger's side factory LCA mount in the same manner as the driver's side.
31. Locate the new front LCAs (A192), this is the longest set of arms. Adjust the arms to 33 3/8" center to center. Remove the pre-installed straight grease fitting and install the provided 90 deg. zerk fittings so they are angling 45 deg. from the arm towards the center of the vehicle once installed.
32. Install the flex end of the new control arms into the new LCA mounts and fasten with 9/16" x 4" bolts, nuts and 9/16" SAE washers (BP 760). The arms bend in toward the center of the vehicle and the grease fitting is on top. Rotate the axle enough to install the arms into the axle with the factory hardware, leave hardware loose.
33. Locate the new front UCA assembly (A193). Adjust the length of the arm to 22-1/8" from the center of the clevis bolt hole to the center of the flex end. Leave the jam nut loose. This is a good starting point for 4 & 6" lifts - adjust as necessary once the lift is complete.
34. Remove the heat shields from the upper control arm mounts. (Fig 15) There is a bolt on the top and bottom of each shield. These will not be reused.

FIGURE 15



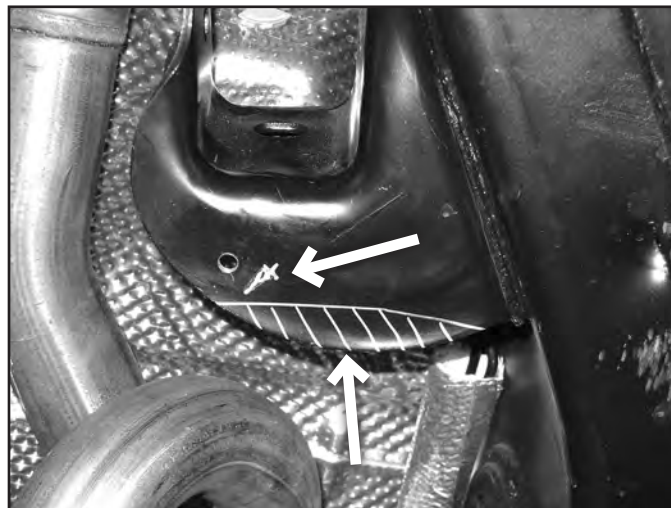
35. Remove the passenger's side UCA from the axle and the frame. Save the bolt/nut from the axle end.
36. Locate the provided UCA mount drill/cut template at the end of the instruction sheet and cut it out. Position the drill template on the bottom face of the factory upper control arm mount so that the profile of the template matches the mount. The straight edge of the template should be parallel to the frame rail (Fig 16A). Mark the center of the hole in the template on the mount. Remove the template and repeat procedure on the other side of the vehicle.

FIGURE 16A



37. Drill a 7/16" hole at the marks made on the factory UCA mounts. Trim along the cut line, making the bottom-rear edge straight (Fig 16B).

FIGURE 16B

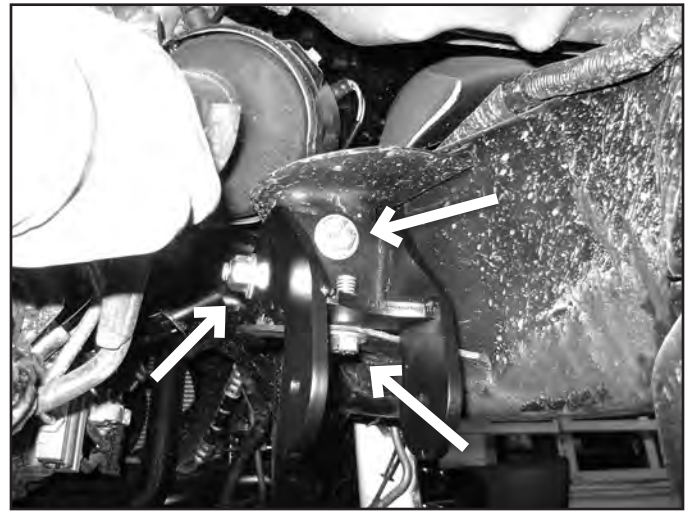


38. Position a provided UCA bracket (01900) onto the backside of the original passenger's side UCA mount. Attach the bracket to the frame mount with 7/16" x 1-1/4" bolts, nuts and washers (BP 761) through the newly drilled lower hole and the existing hole in the backside of the OE mount. Leave hardware loose.
39. Position a provided crush sleeve (92) in the OE UCA mount and fasten the bracket through the OE UCA mount holes and sleeve with a 12mm x 100mm bolt, nut and 1/2" SAE washers (BP 761). Run the bolt from the outside. (Fig 17A,B)
40. With the bracket in position, install one of the front upper control arms in the bracket so the grease zerk is down and loosely fasten with a 12mm x 90mm bolt, nut and 1/2" SAE washers (BP 761).

FIGURE 17A

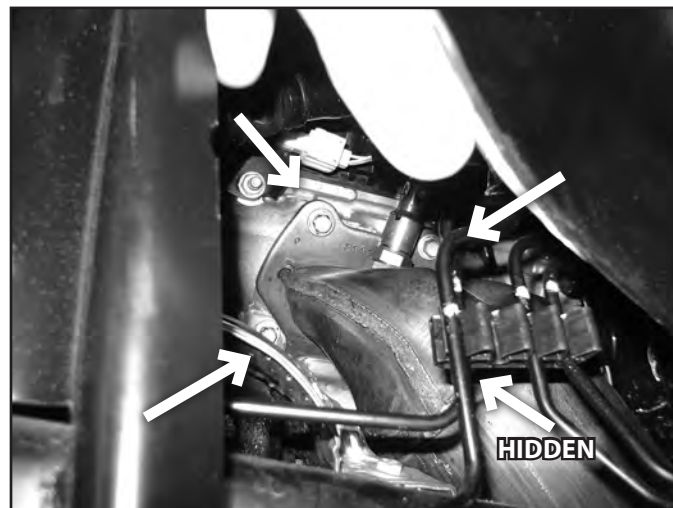


FIGURE 17B



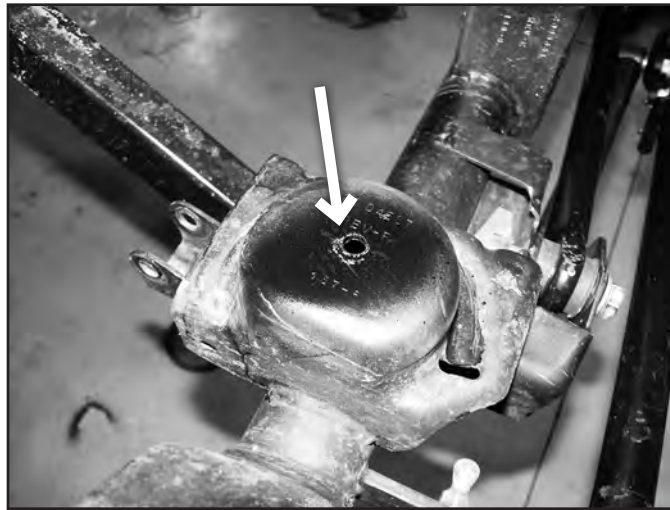
41. With all the UCA mount hardware installed, torque the 7/16" hardware to 45 ft-lbs and the 12mm hardware (including the control arm bolt) to 65 ft-lbs.
42. With the axle still well supported, remove the driver's side UCA and rotate the axle to install the new passenger's side UCA to the axle with the factory hardware. Leave hardware loose.
43. Repeat the UCA bracket installation on the driver's side of the vehicle. The drivers bracket will not slide into position without loosening the exhaust at the engine. There are 4 small bolts mounting the exhaust to the engine. These can be accessed through the wheel well and from under the vehicle. Remove the top 2 bolts and loosen the lower 2 to gain slack/clearance needed to install the new UCA bracket. (Fig 18) Once the bracket is in position, tighten the exhaust hardware securely.

FIGURE 18



44. With the driver's side UCA bracket in position, fasten using the same steps as the passenger's side.
45. Install the new driver's side UCA to the new bracket (new hardware) and OE axle mount (factory hardware). Torque the new hardware at the frame to 65 ft-lbs and leave the axle hardware loose.
Note: Make sure the UCA is installed with the grease fitting pointed down.
46. Be sure the UCA flex ends are square in the pockets and lock off the control arm jam nuts securely.
47. Disconnect the factory shocks from the axle and the frame. Save the lower mount hardware.
48. Locate and mark the center of the coil spring mount on the axle (Fig 19). Drill a 11/32" hole at the mark. Using a provided 3/8" x 1" self-tapping bolt (BP 438) cut threads in the hole and then remove the bolt. This hole will be used to attach the provided bump stop extension to the axle.

FIGURE 19

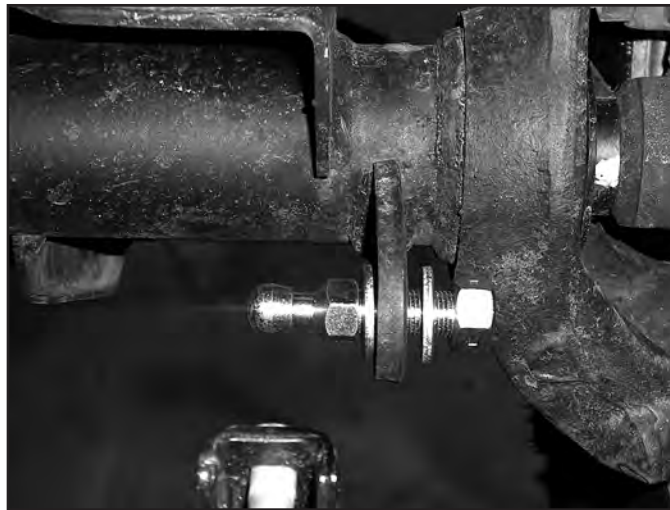


49. Place the provided 3" bump stop extension (3396) in the new coil spring and install the coil spring in the vehicle. Rotate the coil so it seats properly in the axle mount. Attach the bump stop extension to the axle with the 3/8" x 3-1/2" bolts and 3/8" USS washers (BP 438). Use Loctite on the bolt threads and tighten to approx. 20 ft-lbs.
50. Install the new BDS shocks to the axle and frame. Tighten the upper hardware until bushings begin to swell. In the lower mount use the provided sleeve with the small ID. Torque the lower bolt to 65 ft-lbs.

SWAY BAR DISCONNECTS (NON-RUBICON MODELS)

51. Install the new sway bar link disconnect ball stud to the original sway bar link mount on the axle. Attach the stud so that the ball is toward the center of the vehicle. Use one 1/2" SAE washer on each side of the mount and fasten with a 1/2" nut (BP 912). Torque nut to 65 ft-lbs. (Fig 20)

FIGURE 20



52. Locate the new sway bar link assemblies (A169). Ensure that the sway bar disconnect ends are threaded all the way on to the link. Compare the two links side by side to see that they are adjusted to the same length. Leave the jam nut loose at this time.
53. Lightly grease and install the provided sleeves (46) in the new sway bar links assemblies. Attach the new sway bar link assembly to the sway bar with a 1/2" x 3" bolt, nut and 1/2" SAE washers (BP 912). The link will mount to the outside of the sway bar with a 1-3/8" OD extra thick 1/2" washer positioned between the bushing and the sway bar (BP 912). Install the bolt from the outside in and torque to 65 ft-lbs (Fig 21)

Note: It may be necessary to slightly clearance the sway bar holes to accept the 1/2" hardware.

54. Connect the sway bar links to the ball studs on the axle. Adjust the sway bar link ends so that they are square on the ball stud and lock off the jam nut securely.

FIGURE 21



55. Locate the existing inner fender bolt up near the front body mount. Remove the bolt and attach the new lanyard to the inner fender with the bolt. Torque bolt to 10 ft-lbs. (Fig. 22)

FIGURE 22



FIGURE 23



56. Slide the male clip up the lanyard and attach the female clip to it (Fig 23). This will be the stowed position for the lanyard when not it use (when the sway bar is connected)

SWAY BAR LINKS (RUBICON MODELS)

57. Grease and install the provided bushings and sleeves (46) in the new front sway bar links (911111). Attach the links to the inside of the original sway bar link mount on the axle with the original hardware. The link should run inward as it goes up toward the sway bar.
58. Attach the top end of the sway bar links to the outside mounting surfaces of the sway bar with the 1/2" x 3" bolts, nuts and washers provided. Torque the upper and lower hardware to 60 ft-lbs.

Note: It may be necessary to slightly clearance the sway bar holes to accept the 1/2" hardware.

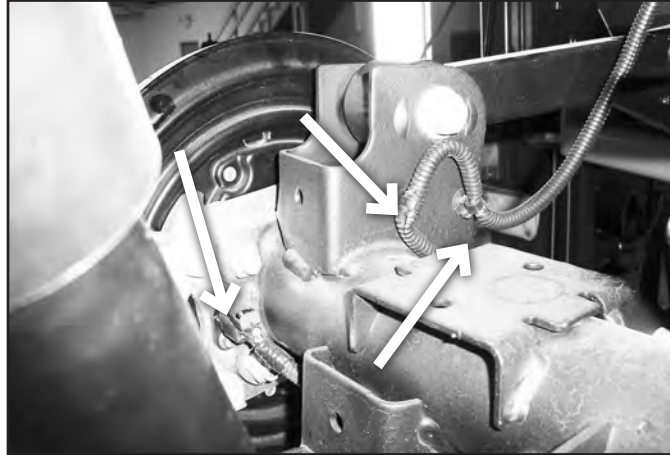
ALL MODELS

59. Install the OE front track bar to the driver's side frame mount with the original hardware. Leave hardware loose. The track bar will be attached to the axle when the weight of the vehicle is on the suspension.
60. Install the steering drag link to the new pitman arm with the OE nut. Torque nut to 65 ft-lbs.
61. Install the front wheels and lower the vehicle to the ground.
62. Bounce the front of the vehicle to settle the suspension. Torque the LCA bolts at the axle and frame to 95 ft-lbs and the UCA bolts at the axle to 65 ft-lbs. Ensure that the flex ends are square to the mounts and lock off the jam nuts.
63. Install the track bar in the new axle bracket with the OE bolt and nut tab. Have an assistant turn the steering wheel to help align the track bar with the hole. Torque both track bar bolts to 125 ft-lbs.

REAR INSTALLATION

1. Block the front wheels for safety. Note the orientation of the rear track bar (driver's side end verses passenger's). Remove the rear track bar from vehicle. Retain hardware and track bar.
2. Raise the rear of the vehicle and support with jacks stands at the rear portion of each frame rail.
3. Remove wheels.
4. Disconnect the ABS sensor wires from axle hubs and remove the retaining clips from axle (Fig 1R).

FIGURE 1R



5. Disconnect the parking brake cable from brakes and axle mounts (Fig 2R). Compress the tabs on the retain clips and pull the cable out of the axle brackets to remove.

FIGURE 2R



6. Disconnect the rear driveshaft from the axle. Retain hardware. *Note: Depending on the lift amount being installed and the vehicle model, the rear driveshaft may need to be replaced. If this is the case remove the driveshaft from the transfer case as well.*
7. Disconnect the factory rear brake line from the hard line at the frame and caliper on the axle. Have a container ready to catch the fluid. Remove bolt mounting the brake line to the frame and discard the brake line. Retain the lower banjo bolt and the frame bracket mounting bolt.
8. Attach the new brake line (22540-drv, 22541-pass, this is the longer set of brake lines) to the caliper with the original banjo bolt and two new crush washers (CCW-03-050). Place a crush washer on each side of the fitting. Torque banjo bolt to 30 ft-lbs. *Note: Make sure that the old crush washers are removed from the bolt and caliper.* When installed in the correct position the brake line fitting will point up and slightly away from the caliper.
9. Install the new brake line mounting bracket (B06103C) on the hard line and then fasten the new brake line to the hard line securely. Do not attach the bracket to the frame at this time.
10. Disconnect the axle breather tube from the plastics retainer (Fig 3R) at the body (passenger's side inner fender). Also, free the tube from the frame by releasing the metal clip. The clip should remain on the tube.

FIGURE 3R



11. Support the axle, disconnect the shocks at the axle. Retain hardware.
12. Disconnect the sway bar links from the sway bar and axle. Retain the links and all mounting hardware.
13. Lower the rear axle and remove rear springs/upper rubber isolators.
14. Loosely reattach shocks to axle. This will help stabilize the axle during the remaining rear suspension installation.
15. Remove the passenger's side upper and lower control arm from the frame and axle. Retain the hardware and discard the LCA.

Warning: The vehicle's fuel tank is located just inside the passenger's side frame rail and close in proximity to the passenger's side LCA mount. Use caution when performing the next step of removing this factory bracket. DO NOT use any type of flame or plasma cutting to perform this procedure. While using any cutting method, a properly charged fire extinguisher should be located close by.

16. The factory LCA mount must be cut off to provide clearance for the new arms under suspension compression. Mark and cut the LCA mount at frame. Cut off bottom and outside of bracket. The inside wing of the bracket can remain intact on the passenger's side, the driver's side can be completely removed. Note: Take care not to cut into the frame. (Figures 4R/5R)

FIGURE 4R

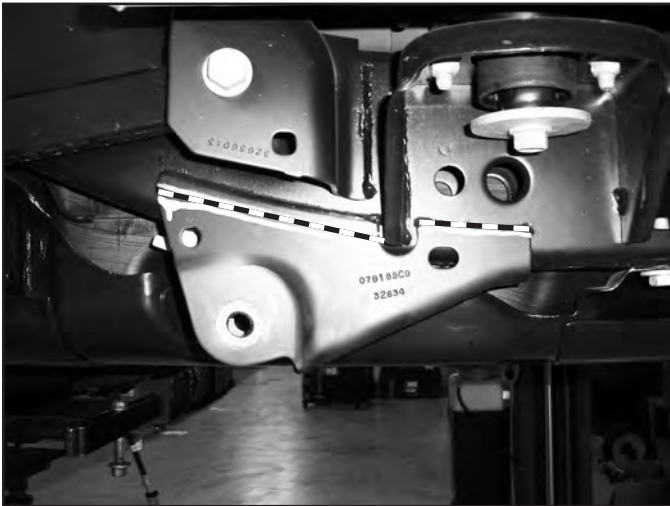
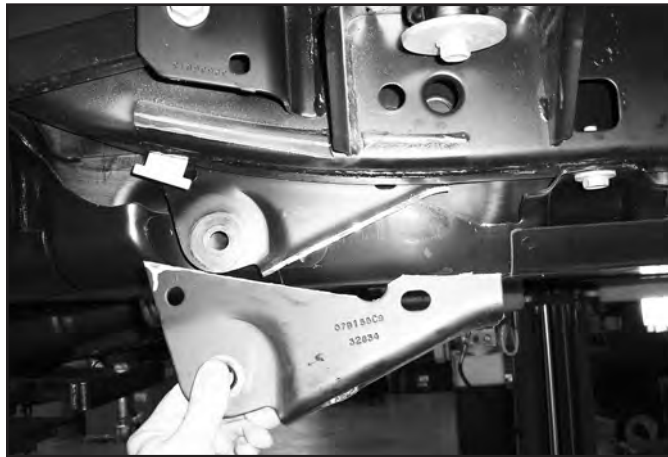


FIGURE 5R



17. After removing the bracket, go back and grind the weld located within the body mount smooth 1" from the end. This will allow the new mounting bracket to lay flush against the frame when installed. (Fig 6R)

FIGURE 6R



18. Remove the drivers and passenger body mount bolts from this location and remove the factory washers. This can be done by placing the bolt between the jaws of a vice or some block of wood and hitting the bolt through the washer.
19. Measure up 1-1/4" from the bottom edge of the body mount, measure from frame over 3/8" and remove section from the body mount. (Figure 7R, 8R)

FIGURE 7R

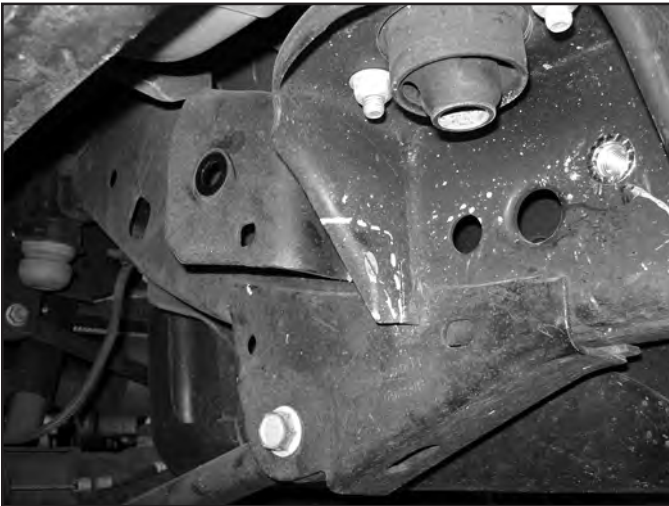


FIGURE 8R



20. Remove the upper control arm pocket from the frame with a sawzall. Trim 1/4"-1/2" away from the frame all of the way up. (Figure 9R, 10R)

FIGURE 9R

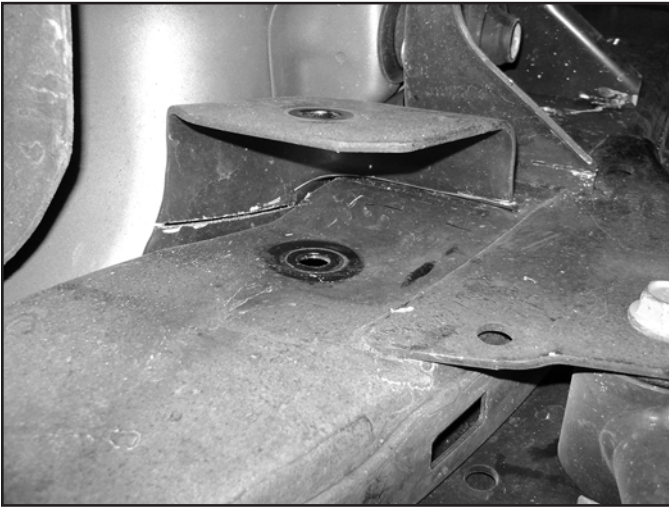
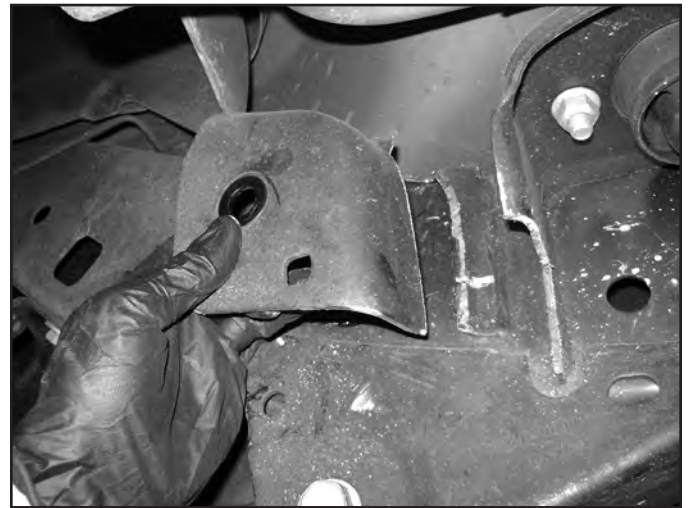


FIGURE 10R



21. Remove gas tank skid plate bolt located just ahead of the factory lower control arm mount. Retain skid plate bolt.
22. Temporarily install the new bracket passenger's side control arm bracket (01986) with the new 12mm x 35mm bolt.
23. Mark holes to drill (Fig 11R/12R). Use drill template at the end of this instruction sheet to locate the hole to be drilled through the front side of the body mount (Fig 14R – driver's side shown). Set the edge of the template up flush to the frame surface. *Note: The inside of this template hole can be marked from the bracket to double check your hole position once the pilot hole has been drilled.*

FIGURE 11R

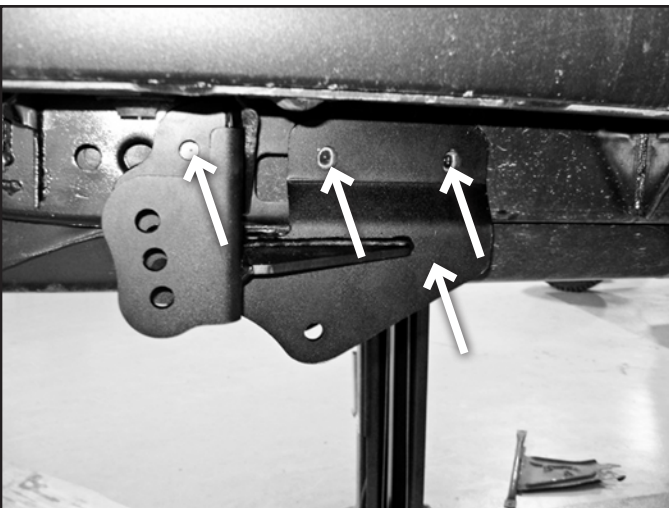


FIGURE 12R



24. Remove the bracket and drill 11/16" holes at each of the 3 marks made on the frame rail. Drill the body mount hole to 1/2". Drill the hole in the bottom of the frame out to 9/16". This will provide clearance for the bolt to pass through with the fish wire attached.
25. Install the rivet nuts into the frame rail with 1/2" x 2-1/2" bolt, 9/16" high nut, washer, and serrated edge washer (BP 762) as shown. The rear 2 holes will take the short rivet nut, the forward most hole will take the long rivet nut. Tighten until the rivet nut is secure. (Fig 13R, 14R, 15R)

🔧 *Note: See the end of this instruction sheet for more detailed rivet nut installation instructions.*

FIGURE 13R



FIGURE 14R



FIGURE 15R



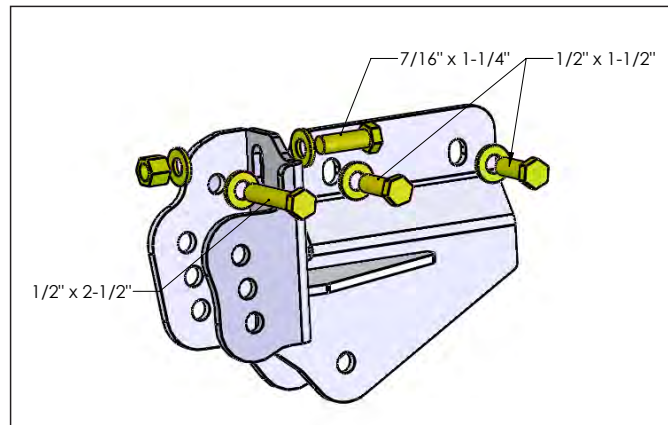
26. Use the provided fish wire to pull the 1/2" bolt tab (01797) through the frame (Fig 16R). Note: Do not put a washer on the bolt tab.

FIGURE 16R



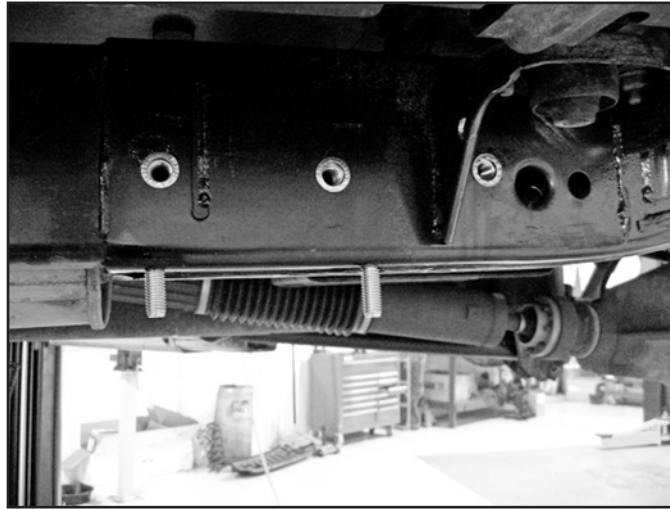
27. Reattach the bracket to the frame with new 12mm-1.50 x 35mm bolt with 12mm flat washer thru the OE skidplate mount. All the hardware for the rear control arm brackets is located in bolt pack #762. Install $\frac{1}{2}$ " x 1-1/2" bolts and $\frac{1}{2}$ " SAE washers into the rivet nuts. Fasten the bracket through the hole drilled into the body mount with a $\frac{7}{16}$ " x 1-1/4" bolt, nut and $\frac{3}{8}$ " USS washers. Fasten the bolt tab running out the bottom of the frame with a $\frac{1}{2}$ " nut and $\frac{1}{2}$ " SAE washer. Leave hardware loose until all hardware is installed. Torque $\frac{1}{2}$ " hardware to 65 ft-lbs and $\frac{7}{16}$ " hardware to 50 ft-lbs. Note: Use Loctite on bolts that go into rivet nuts. (Figure 17R)

FIGURE 17R



28. Install the new control arm bracket (01985) on driver's side frame. Locate the bracket just like the passenger's side. Clamp bracket into place and mark all holes to be drilled.
29. Drill holes at the marks to the same sizes as on passenger's side. Use the drill template to locate the body mount hole. (Fig 18R). The 3 holes into the side of the frame rail will need to be drilled to $\frac{11}{16}$ " to accept rivet nuts. The hole thru the body mount will be $\frac{1}{2}$ " and the 2 holes that run from the bottom - up into the frame will need to be $\frac{9}{16}$ "

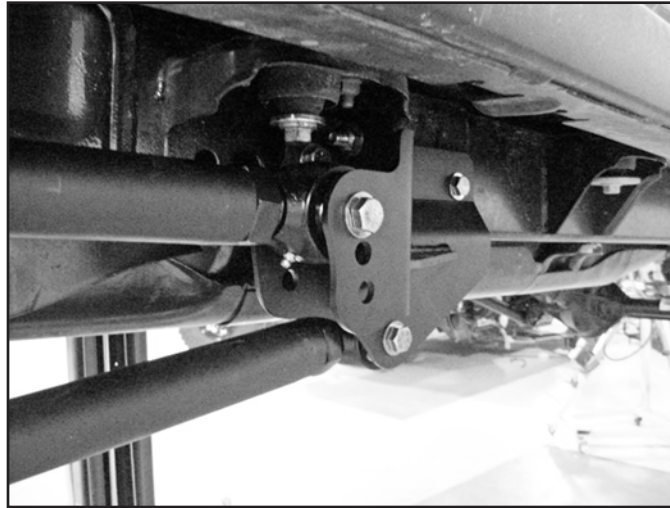
FIGURE 18R



30. Use 1/2" x 2-1/2" bolt to install the rivet nuts just like on the passengers side. The front hole will take the long rivet nut, the rear 2 holes will take short rivet nuts.
31. Use the fish wire to pull bolt tabs (01797) through the frame into the 2 bottom holes (Fig 20R).
32. Attach the bracket to the frame with the 1/2" nuts and 1/2" SAE washers on the two bolts tabs running out the bottom of the frame. Fasten the bracket through the hole drilled into the body mount with a 7/16" x 1-1/4" bolt, nut and 3/8" USS washers. Install a second 7/16" x 1-1/4" bolt and 3/8" USS washer through the hole located inside the body mount. Install a 1/2" x 1-1/2" bolt and 1/2" SAE washer through the remaining holes into the rivet nuts. Leave hardware loose until all hardware is installed. Torque 1/2" hardware to 65 ft-lbs and 7/16" hardware to 50 ft-lbs. Note: Use Loctite on bolts that go into rivet nuts.
33. Install new body mount bolts with the thick washer from bolt pack 762. Repeat on opposite side. Tighten to 65 ft-lbs.
34. Go back and double check hardware. Torque 1/2" hardware to 65 ft-lbs and 7/16" hardware to 50 ft-lbs.
35. Locate the new rear LCAs (A194), Adjust the arms to 32 3/4" center to center. The ends are not parallel so be sure to measure from the center of the control arms. Remove the pre-installed straight grease fitting and install the provided 90 deg. zerk fittings so they are angling 45 deg. from the arm towards the center of the vehicle once installed.
36. Install the new LCA into the axle with the OE hardware. The LCAs are formed inward to clear the tire.
37. Install flex end into new LCA bracket. Attach with 9/16" x 4" bolt, washers, and nut (BP 762). The grease fitting should be on top. Leave loose at this time.
38. Locate the new rear upper control arms and adjust the length to 25-1/2" for 4 doors with 4.5-6.5" of lift or 26" for 2 doors with 4.5-5.5" kits. Measurement is from the center of end, to center of end. This is a good starting point and may need to be tweaked if a driveshaft vibration is present.
39. Install the UCAs to the axle with the OE hardware. Attach the adjustable end to the frame bracket with a 9/16" x 4" bolt, washers, and prevailing torque nuts (BP 762). Leave hardware loose at this time (Figure 19R).

Note: It is recommended to use the upper most hole in the long arm bracket for all lift kits. To reduce rear anti-squat, choose a lower hole.

FIGURE 19R



5.5" AND 6.5" KITS ONLY (STEPS 40-50)

40. The coil spring retaining boss on each of the coil axle mounts needs to be removed (Fig 20R). Using a reciprocating saw (recommended), or cut-off wheel, cut the boss off flush to the coil mount surface (Fig 21R) Once removed, paint the exposed metal.

FIGURE 20R



FIGURE 21R



41. Locate the new provided coil mounts. Place the mounts over the factory mounts so that the new mount wraps around the back side of the axle tube and is centered over the factory mount (Fig 22R, 23R). Note the areas to be welded on each side of the mount to the axle and at the front where the new mount rests on the factory one.

FIGURE 22R

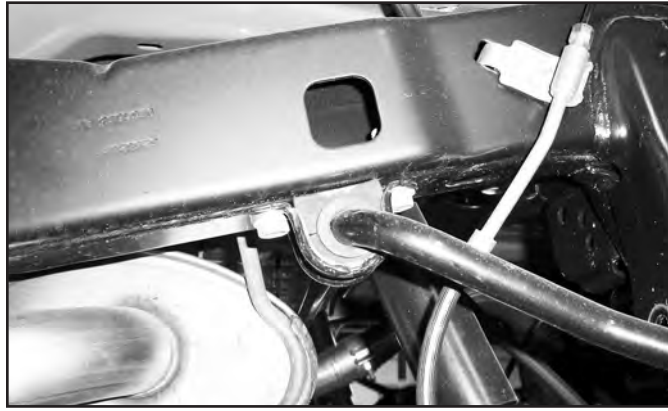


FIGURE 23R



42. Remove the new coil mounts and remove any paint, rust, oil, etc from the areas to be welded.
43. Reposition the new mounts as before and tack weld in place. Double check the mount position and fully weld in place.
44. Allow the welds to cool and paint the new mounts and welds.
45. Disconnect the sway bar from the frame and remove it from the vehicle. Retain the sway bar, bushings, and hardware (Fig 24R).

FIGURE 24R



46. Install sway bar drop brackets with OE sway bar mounting bolts to frame rails. Brackets will be offset toward the rear (Fig 25R). Mark the hole to the rear of the existing OE holes.

FIGURE 25R



47. Remove bracket and drill a 11/32" hole at the mark.
48. Reinstall bracket with OE hardware and 3/8" x 1-1/4" self tapping bolt (BP 759) in the new hole. Torque hardware to 30 ft-lbs.
49. Install the sway bar to the new drop brackets with 7/16" x 1-1/4" bolts, nuts and 7/16" SAE washers (BP 759). Torque 7/16" hardware to 50 ft-lbs.
50. Attach the OE sway bar links to the sway bar and axle with the OE hardware. Torque hardware to 55 ft-lbs.

4" KITS ONLY (STEP 51)

51. Grease and install the 5/8 ID hourglass bushings (SB58BK) and 12mm ID x 1.375 long sleeves (62147) into the provided links (92025). Attach sway bar links to axle with OE hardware and at the sway bar with new 12mm bolts, nuts and washers (BP758). Run the upper bolt from the outside in for wheel clearance. The links will mount to the outer surfaces of the sway bar and axle mount tab (Fig 26R)

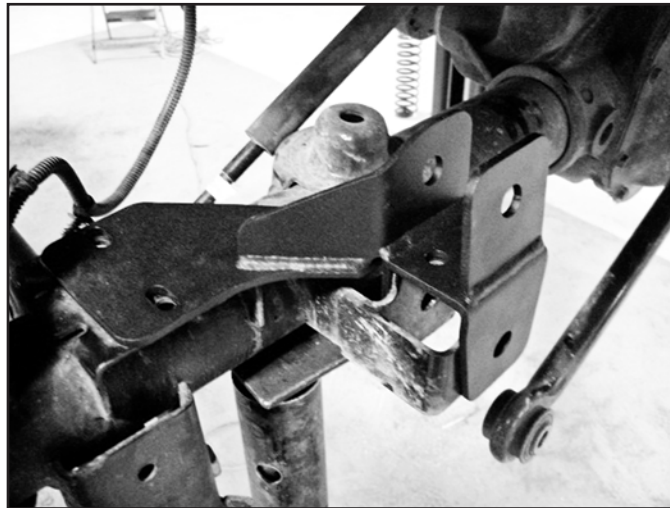
FIGURE 26R



ALL LIFTS

52. Install the new track bar bracket (01987) over the OE axle bracket so that the support wing rests on the flat bump stop pad on the axle. Mark hole to be drilled on the top of the OE bracket using the hole in the new bracket as a guide.
53. Remove the bracket and drill a 7/16" hole at the mark.
54. Install the bracket with 3/8" x 1-1/4" hardware (BP 563) in the new hole. Position the provided crush sleeve (54587) in the factory mount position and install a 9/16" x 3-1/2" bolt, nut and 9/16" washers (BP 563) through the bracket a crush sleeve. Leave hardware loose (Fig 27R).

FIGURE 27R



55. Place a provided bump stop extension (01999 - 6in, 01928 - 4in) over the track bar wing and line up the holes in the bracket with the holes in the wing and axle mount. 6 inch systems - install the bump stop so it offsets forward. 4" systems - install the spacer using the holes in the narrow side to set the height off the pad at 3 inches. Fasten the bump stop and track bar wing to the axle with 5/16" x 1-1/4" bolts, nut and 5/16" washers (BP 763). Run the bolts from the bottom up.
56. With all of the track bar hardware installed, go back and torque the 9/16" bolt to 95 ft-lbs, 3/8" hardware to 30 ft-lbs and 5/16" hardware to 17 ft-lbs.
57. Install OE rear track bar into the relocation bracket with a 9/16" x 3" bolt, nut and 9/16" washers (BP 563) making sure track bar is orientated correctly. The bolt must run from FRONT TO REAR to avoid contact between the coil spring and the bolt. Leave bolt loose.
58. Install bump stop pad on passenger's side similar to the driver side using the 5/16" x 7/8" hardware (BP 763), tighten to 17 ft-lbs.
59. Support the rear axle with a jack and remove OE shocks (save hardware). Lower the axle and install the new rear coils with OE rubber isolator on top. The small end of the coil spring should be installed at the axle. Do not overextend the brake lines.
60. Install the new rear shocks with the OE hardware. Torque the upper bolts to 30 ft-lbs and lower bolts to 60 ft-lbs.
61. Disconnect the wire parking brake cable retainer from the body (Fig 28R). Remove the cables from the retainer. Reroute the cables under the OE frame rail cross member and reattach them to the brakes and axle brackets.

62. Reattach the ABS wire connectors to the brakes by routing them over the top of the axle. Use provided zip ties (099002) with press in retainer plug into an existing hole in the upper control arm mount (Fig 29R).

FIGURE 28R



FIGURE 29R



63. Attach new brake lines 'L' bracket to the frame rail with OE hardware. Tighten hardware securely.
64. Reattach the driveshaft to the rear axle with the OE hardware or install new drive shaft if required.
65. Reconnect the axle breather tube to the frame using the original metal clip. With the axle hanging the tube should have a slight amount of slack. Be sure to position it away from the exhaust so it will not rest against it at any point during normal suspension travel.
66. Install the wheels. Lower the vehicle and install rear track bar into OE frame mount with OE hardware. Torque the track bar bolts at the axle and frame to 95 ft-lbs.
67. Torque the LCA and UCA bolts at the axle to 95 ft-lbs, the LCA bolts at the frame to 95 ft-lbs and the UCA bolts at the frame to 55 ft-lbs.
68. Make sure the upper and lower flex ends are square in the pocket and securely lock off the jam nuts.

POST INSTALLATION

1. Bleed the complete brake system.
2. Check all hardware for proper torque.
3. Check all brake lines, hoses, wires, etc for proper slack and clearance through wheel travel.
4. Lubricate all greaseable control arm ends.
5. The steering wheel must be adjusted before driving the vehicle.
6. Check all hardware after 500 miles, at every schedule service interval and after any heavy offroad use.
7. Check the rear tire clearance to the sharp point of the rear pinch weld. Depending on the tire/wheel setup used, the pinch weld may need to be trimmed or bent over to ensure it will not hit the tire under full suspension compression.

DETAILED RIVET NUT INSTALLATION INSTRUCTIONS

RIVET NUT SIZING

1. Verify the correct size rivet nut for the application based on the thickness of material where the rivet nut is to be installed using the following chart.

Part Number	Thread Size	Body Length (in)	Material Thickness (in)		Drill Size (in)
			Min.	Max.	
95105A159	3/8-16	.690	.027	.150	17/32
95105A168	3/8-16	.805	.150	.312	17/32
95105A169	1/2-13	1.150	.063	.200	11/16
95105A170	1/2-13	1.300	.200	.350	11/16

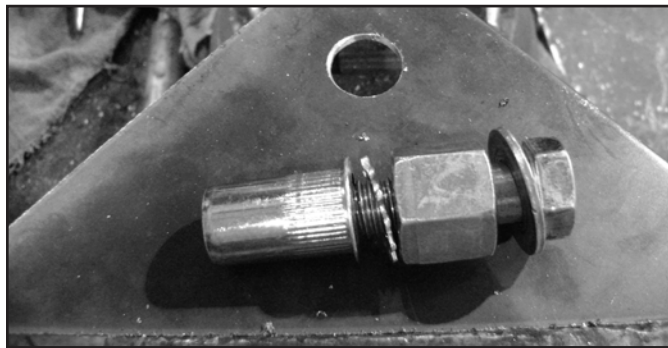
HOLE PREPARATION

2. Drill hole to appropriate size for rivet nut installation. 1/2" Rivnuts require an 11/16" hole and 3/8" Rivnuts require a 17/32" drill. It is critical that this hole is drilled to the correct size. Remove any burrs that could keep the rivet nut from seating flat against either side of the hole surface.
Note: If the correct drill size is not available, it is possible to drill the hole to an available smaller size and slowly grind it out to until the rivet nut fits tight.

RIVET NUT INSTALLATION TOOL ASSEMBLY

3. For a 3/8" rivet nut, place the provided 3/8" SAE flat washer on the 3/8" x 1-1/2" bolt, followed by 7/16" hex nut and then a 3/8" serrated washer. **Figure 1** Thread this tool assembly into the rivet nut.
4. For a 1/2" rivet nut, place the provided 1/2" SAE washer on a 1/2" x 2" bolt followed by a 9/16" high nut and 1/2" serrated edge lock washer. Thread this tool assembly into the rivet nut as shown. (Fig. 1)

FIGURE 1 - 1/2" RIVET NUT SHOWN



RIVET NUT INSTALLATION

5. Place the installation tool with the rivet nut threaded on the end into the appropriately sized hole.
6. For a 3/8" rivet nut, hold the nut closest to the rivet nut still with a 5/8" wrench and tighten the 3/8" bolt with a 9/16" wrench to set the rivet nut. Be sure to hold the rivet nut flush to the surface and square to the hole as it is tightened. **Figure 4**
Note: If available, an impact gun is recommended for tightening the bolt to ensure the rivet nut remains square to the hole and to ease holding the nut from spinning.
7. For a 1/2" rivet nut, hold the nut closest to the rivet nut still with a 7/8" wrench and tighten the 1/2" bolt with a 3/4" wrench to set the rivet nut. Be sure to hold the rivet nut flush to the surface and square to the hole as it is tightened. **Figure 2**

FIGURE 2 - 1/2" RIVET NUT SHOWN



TORQUE SPECIFICATIONS

8. 3/8" rivet nuts will approach 40 ft. lbs for maximum grip strength. Do not exceed 45 ft-lbs when setting the rivet nut.
9. 1/2" rivet nuts will approach 90 ft lbs for maximum grip strength. Do not exceed 100 ft-lbs when setting the rivet nut.
Note: If using the recommended impact gun, use caution to not exceed the recommended torque specifications.

RIVET NUT TOOL REMOVAL

10. Once the center bolt is tightened, remain holding the nut from spinning with the wrench and loosen the center bolt to remove the installation tool.

⚠️ *IMPORTANT* *It is very important to hold the nut as the bolt is loosened because the grip of the star washer will try to spin the rivet nut and ruin the installation.*

11. Verify proper installation by checking for consistent rivet nut deformation to see the threads are square and centered to the rivet nut. Figure 3.

FIGURE 3



WE WANT TO SEE YOUR RIDE!

Grab photos of your BDS-equipped truck in action and send them in for a chance to be featured. Send it in to our Bad Ass Rides customer gallery at bds-suspension.com/bar and post them on the BDS Fan Page on Facebook at facebook.com/BDSSuspensions. Don't forget about your BDS swag! BDS offers t-shirts, hoodies, decals and more available on the BDS website or through your local BDS distributor.

TIME TO HAVE SOME FUN

Thank you for choosing BDS Suspension.

For questions, technical support and warranty issues relating to this BDS Suspension product, please contact your distributor/installer before contacting BDS Suspension directly.

