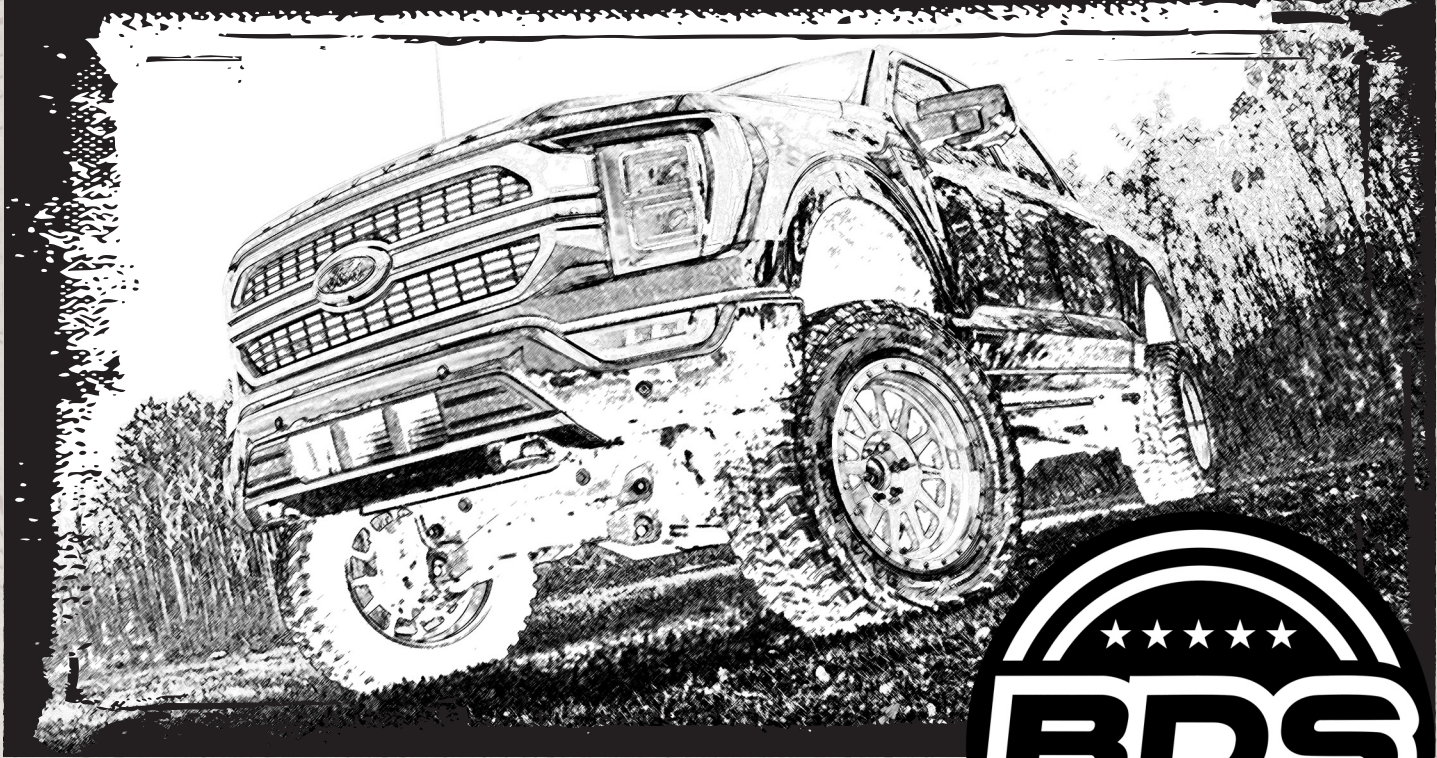


# INSTALLATION GUIDE



Part#: 123427



**HARDCORE LIMITED LIFETIME WARRANTY**

## Ford F-150 Recoil Traction Bar System

Ford F-150 | 2021-2026

Rev. 010726

491 W. Garfield Ave., Coldwater, MI 49036 • Phone: 517-279-2135

Web: [www.bds-suspension.com](http://www.bds-suspension.com) • E-mail: [tech-bds@ridefox.com](mailto:tech-bds@ridefox.com)

# Read And Understand All Instructions And Warnings Prior To Installation Of System And Operation Of Vehicle.



## THANK YOU

Your truck is about to be fitted with the best suspension system on the market today. That means you will be driving the baddest looking truck in the neighborhood, and you'll have the warranty to ensure that it stays that way for years to come.

Thank you for choosing BDS Suspension!

### BEFORE YOU START

BDS Suspension Co. recommends this system be installed by a professional technician. In addition to these instructions, professional knowledge of disassembly/ reassembly procedures and post installation checks must be known.

### FOR YOUR SAFETY

Certain BDS Suspension products are intended to improve off-road performance. Modifying your vehicle for off-road use may result in the vehicle handling differently than a factory equipped vehicle. Extreme care must be used to prevent loss of control or vehicle rollover. Failure to drive your modified vehicle safely may result in serious injury or death. BDS Suspension Co. does not recommend the combined use of suspension lifts, body lifts, or other lifting devices. You should never operate your modified vehicle under the influence of alcohol or drugs. Always drive your modified vehicle at reduced speeds to ensure your ability to control your vehicle under all driving conditions. Always wear your seat belt.

### BEFORE INSTALLATION

- Special literature required: OE Service Manual for model/year of vehicle. Refer to manual for proper disassembly/reassembly procedures of OE and related components.
- Adhere to recommendations when replacement fasteners, retainers and keepers are called out in the OE manual.
- Larger rim and tire combinations may increase leverage on suspension, steering, and related components. When selecting combinations larger than OE, consider the additional stress you could be inducing on the OE and related components.
- Post suspension system vehicles may experience drive line vibrations. Angles may require tuning, slider on shaft may require replacement, shafts may need to be lengthened or trued, and U-joints may need to be replaced.
- Secure and properly block vehicle prior to installation of BDS Suspension components. Always wear safety glasses when using power tools.
- If installation is to be performed without a hoist, BDS Suspension Co. recommends rear alterations first.
- Due to payload options and initial ride height variances, the amount of lift is a base figure. Final ride height dimensions may vary in accordance to original vehicle attitude. Always measure the attitude prior to beginning installation.

### BEFORE YOU DRIVE

Check all fasteners for proper torque. Check to ensure for adequate clearance between all rotating, mobile, fixed, and heated members. Verify clearance between exhaust and brake lines, fuel lines, fuel tank, floor boards and wiring harness. Check steering gear for clearance. Test and inspect brake system.

Perform steering sweep to ensure front brake hoses have adequate slack and do not contact any rotating, mobile or heated members. Inspect rear brake hoses at full extension for adequate slack. Failure to perform hose check/ replacement may result in component failure. Longer replacement hoses, if needed can be purchased from a local parts supplier.

Perform head light check and adjustment.

Re-torque all fasteners after 500 miles. Always inspect fasteners and components during routine servicing.

# CONTENTS OF YOUR KIT

Box Kit 123427		
Part #	Qty	Description
02972	2	Ford F150 Axle Mount
02876	2	Ford F150 Frame Mount
05069	1	Frame Bracket Nut Tab - Drv
05070	1	Frame Bracket Nut Tab - Pass
02910	2	Jam Nut Wrench
W96S	8	9/16" SAE Washer
469	1	Bolt Pack (Frame Mount Hardware)
	4	1/2"-13 x 1-1/2" Bolt, Grade 8
	4	1/2" SAE Washer
964	1	Bolt Pack (Traction Bar Hardware)
	4	9/16"-12 x 4" Bolt Grade 8
	4	9/16"-12 Prevailing Torque Nut
	8	9/16" SAE Washer

Box Kit 123409		
Part #	Qty	Description
A255	2	Traction Bar Assembly
02865	1	Traction Bar
02866	1	Spacer Washer
02867	1	Bushing
02868	1	Guide Bolt
02869	1	Traction Bar Slider End
033001	1	Heavy Rate Spring
033002	1	Lite Rate Spring
9452K63	2	O-Ring
91985A231	1	Internal Retaining Ring
3537BK	2	Bushings
168	1	Sleeve
4138209	2	Flush Mount Grease Fitting
A171	1	Forged Flex Joint End

# INSTALLATION INSTRUCTIONS

## INSTALLATION INSTRUCTIONS

## SPECIAL TOOLS

Carbide Burr Die Grinder

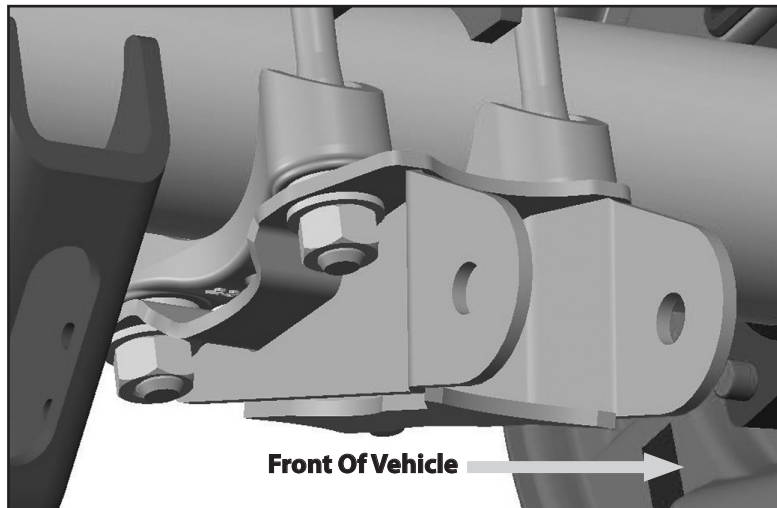
### AXLE BRACKET

1. Park the vehicle on a clean, flat surface and block the rear wheels for safety.

**! Caution** *This installation must be done with the weight of the vehicle on the rear axle. Do not raise the vehicle and allow the rear axle to hang.*

2. Measure the length of the thread on the U-bolt showing past the end of the nut. A minimum of 0.25" of thread must be showing past the end of the nut in order to safely install the axle bracket. If not enough thread is showing, new / longer U-bolts will be required.
3. Remove the driver's side U-bolt nuts and washers. If replacing U-bolts, remove old and install new now.
4. With the OE U-bolt plate in place, install a 9/16" SAE washer on each end of the u-bolts followed by the new traction bar axle mount bracket (02972). Make sure the mounting tabs on the bracket are to the front of the vehicle. Fasten the bracket with the U-bolt (new or used) nuts and washers (Fig 1). Torque U-bolts evenly to 100 ft-lbs.

**FIGURE 1**

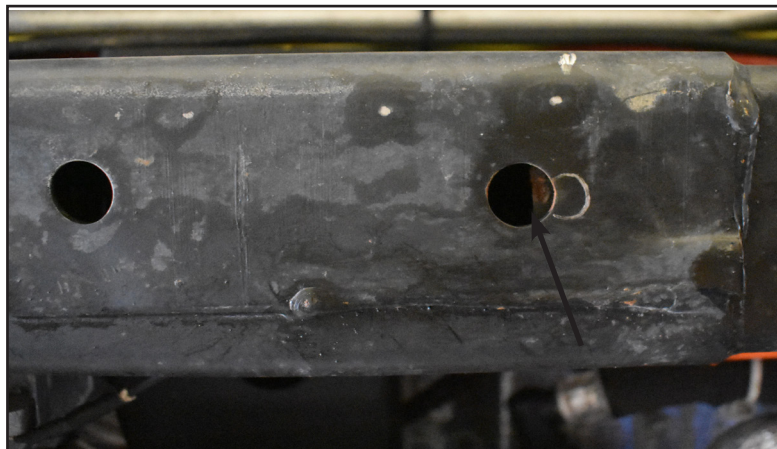


5. Repeat bracket installation on passenger's side.

### FRAME BRACKET

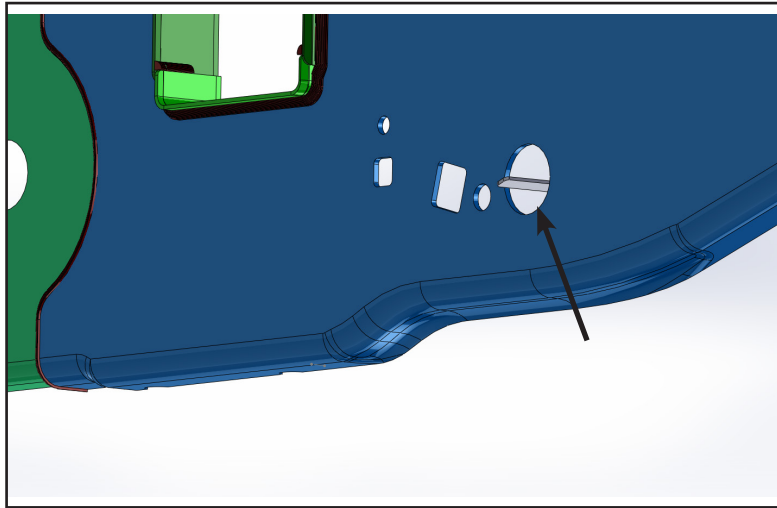
6. Starting on the driver's side, locate the hole on the underside of the frame near where two frame sections meet and are welded together. The hole will be partially blocked (Fig 2).

**FIGURE 2**



7. Using a carbide burr die grinder, clearance the obstructing sheet metal to allow a bolt to pass through the hole.
8. Insert the nut tab through the large hole in the frame towards the outside (Fig 3). The nut tabs are side specific, so be sure to use the correct one.

**FIGURE 3**



9. If installed correctly, the holes in the nut tab should be visible from the two holes in the frame (Fig 4).

**FIGURE 4**



10. Using the 1/2" hardware found in bolt pack 469, attach the frame bracket to the frame using 2 bolts and washers (Fig 5). Frame brackets are not side specific. The Bolts can be torqued to 80 ft-lbs.

**FIGURE 5**



### **TRACTION BAR INSTALLATION**

11. Attach the Recoil traction bar to the axle mount with a 9/16" x 4" bolt, 9/16" nut and (2) 9/16" SAE washers from bolt pack 964. Install the traction bar so that the Forged Flex End (A171) is mounted to the axle bracket. Leave hardware loose at this time.
12. Measure the length of the bar from the center of the bolt at the axle to the center on the sleeve at the traction bar end. The length should be approximately 60". If not, press firmly on the traction bar to seat the springs.
13. Attach the traction bar to the frame bracket using a 9/16" x 4" bolt, 9/16" nut and (2) 9/16" SAE washers from bolt pack 964. Adjust the length using the forged flex end at the axle if needed.
14. At this time, the 9/16" hardware can be torqued to 90 ft-lbs.
15. Repeat installation on opposite side of vehicle.
16. Grease all bushings and the recoil traction bar before use. Do not over grease the recoil traction bar, it is recommended to grease the Recoil Traction Bar one pump of grease every 10,000 miles.

*Note: Traction Bar frame end requires a needle nozzle to grease the flush mount grease fittings.*

17. Check all hardware for proper torque.
18. Check hardware after 500 miles.

### **TRACTION BAR ADJUSTMENT**

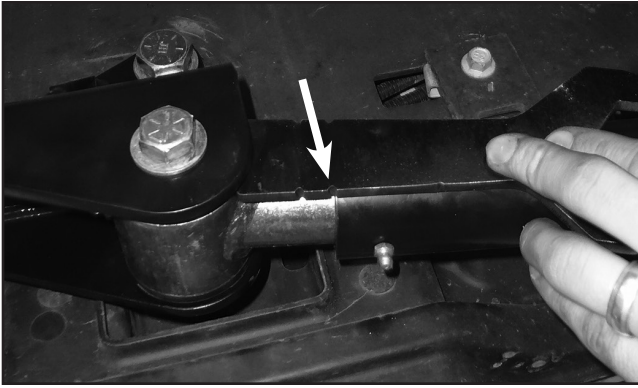
19. Loosen the jam nut at the axle end with the two provided wrenches. Utilize a 1/2" ratchet or breaker bar in the wrench if needed (Fig 6).

**FIGURE 6**

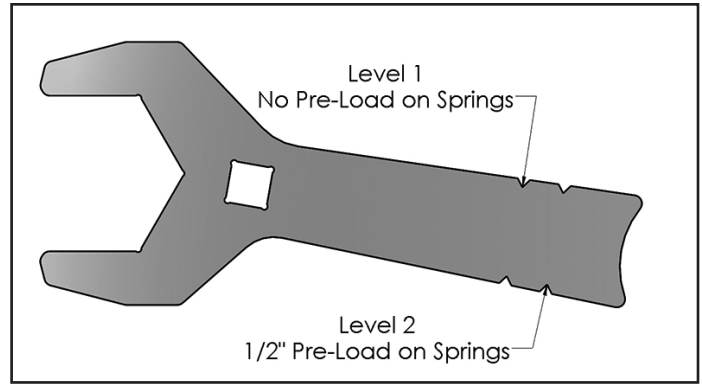


20. Use the levels on the wrench to gauge how much force is inputted into the Recoil Traction Bar. The wrench is designed to be used at the traction bar slider end as shown in Figure 7. Make sure the wrench is pressed firmly against the bushing / tube for an accurate measurement.

**FIGURE 7**

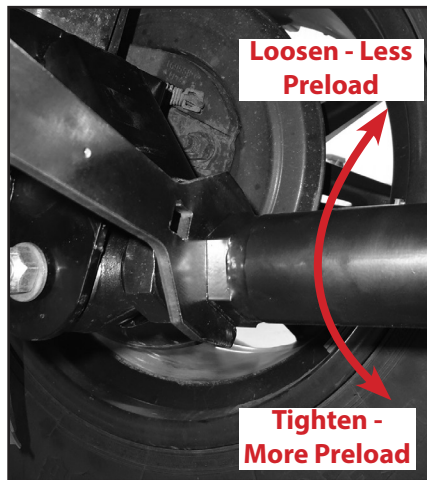


**FIGURE 8**



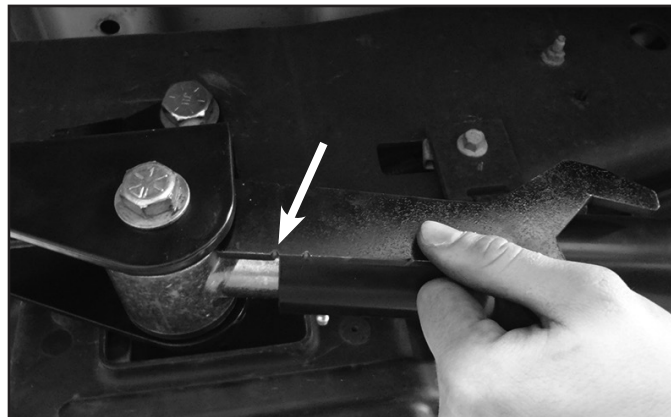
21. Utilizing the Levels on the wrench, spin the Recoil Traction Bar either clockwise to add more force into the dual coil springs setup to reduce axle wrap, or loosen the Recoil Traction Bar by spinning it counter clockwise in order to reduce the input the Recoil Traction Bar has on the suspension system. *Note: Depending upon lift height, the Recoil Traction Bar may need to unthreaded from the Forged Flex End until the First Level is reached on the wrench. At this point the dual coil spring setup are in contact and there is no preload in the springs.*

**FIGURE 9**



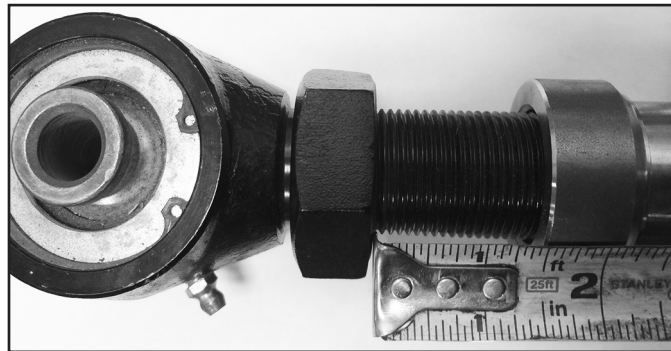
22. It is recommended when pulling or hauling heavy weights that Recoil Traction Bar be set at a minimum of the Second Level on the Jam Nut Wrench to help reduce axle wrap. The Second Level is 25% of the maximum force the springs output. The maximum amount of force that can be preloaded in the spring is 12 full rotations of the Recoil Traction Bar when starting at the First Level. This equals 1" of total preload in the dual coil spring setup in the Recoil Traction Bar. At this point, the dual coil spring setup creates a solid link between the frame and axle when in compression. **DO NOT** tighten the Recoil Traction Bar past this amount.

**FIGURE 10**



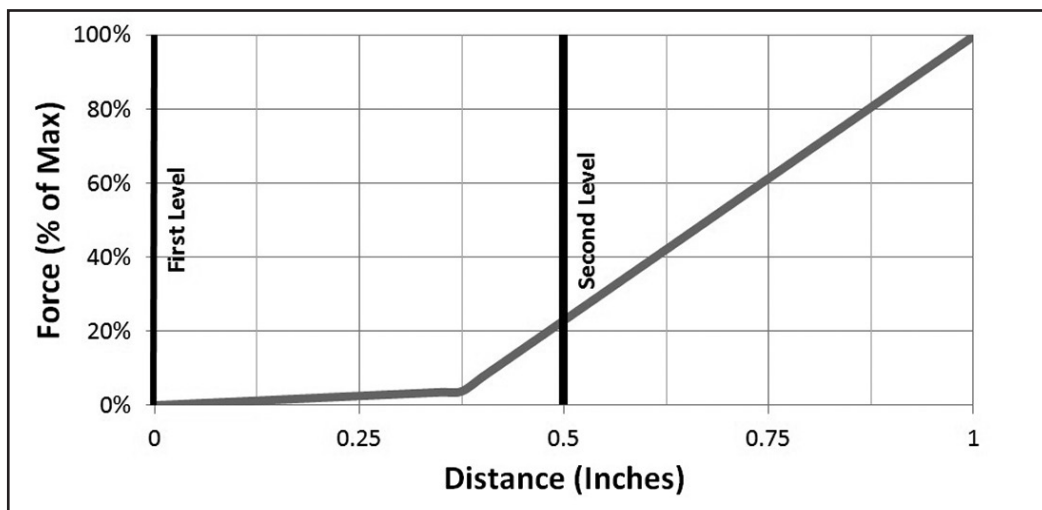
23. After the desired force is set, lock off the jam nut with the two provided Jam Nut Wrenches and repeat this process on the other Recoil Traction Bar. *Note: Never unthread the forged flex end past 1-1/2" of adjustment. This can cause thread damage and weaken the joint. See Figure 11.*

**FIGURE 11**



24. The dual coil spring setup is utilized to always create contact between both ends of the Recoil Traction Bar. Having dual coil spring setup allows the Recoil Traction Bar system to not affect suspension performance at a lower force as seen at the First Level, allowing greater articulation and less affect on the suspension system. As the Recoil Traction Bar is adjusted and the dual coil spring setup are compressed, a higher force is exerted on the axle in order to reduce axle wrap. Each Level below corresponds to the levels on the wrench, representing different amounts of force in the Recoil Traction Bar system. *Note: It is recommended to never fully compress the spring past the 1" of compression. This can be measured 1" from the First Level on the Jam Nut Wrench.*

**FIGURE 12**



**WE WANT TO SEE YOUR RIDE!**

Grab photos of your BDS-equipped truck in action and send them in for a chance to be featured. Send it in to our Bad Ass Rides customer gallery at [bds-suspension.com/bar](http://bds-suspension.com/bar) and post them on the BDS Fan Page on Facebook at [facebook.com/BDSsuspensions](https://facebook.com/BDSsuspensions). Don't forget about your BDS swag! BDS offers t-shirts, hoodies, decals and more available on the BDS website or through your local BDS distributor.

**TIME TO HAVE SOME FUN**

**Thank you for choosing BDS Suspension.**

For questions, technical support and warranty issues relating to this BDS Suspension product, please contact your distributor/installer before contacting BDS Suspension directly.