

INSTALLATION GUIDE

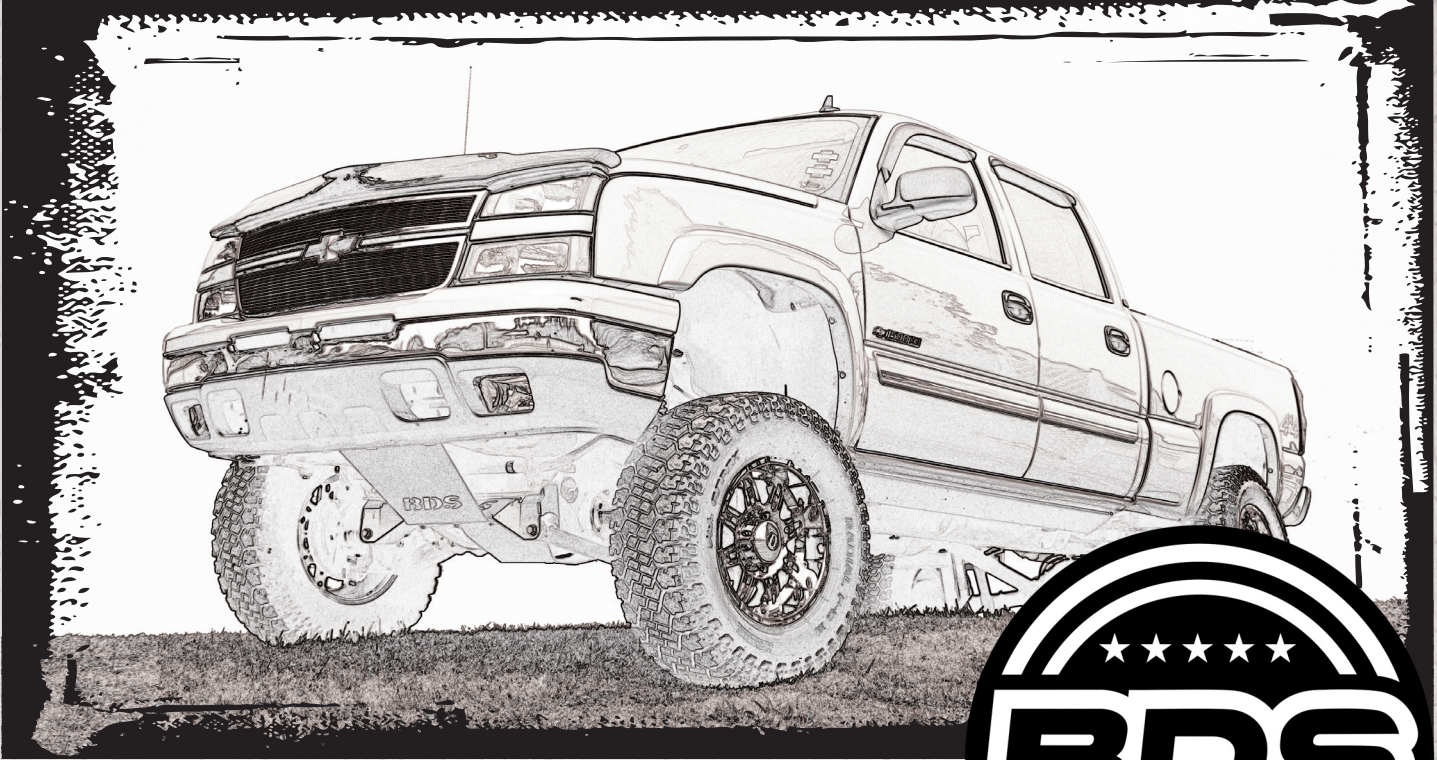

Part#: 021442



HARDCORE LIMITED LIFETIME WARRANTY

Coilover Conversion Suspension System

Chevy/GMC 2500 & 3500 HD 4WD | 2001-2010

Rev.070325

491 W. Garfield Ave., Coldwater, MI 49036 • Phone: 517-279-2135

Web: www.bds-suspension.com • E-mail: tech-bds@ridefox.com

Read And Understand All Instructions And Warnings Prior To Installation Of System And Operation Of Vehicle.

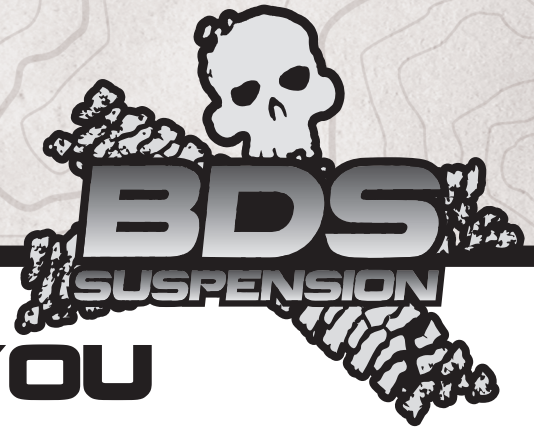

THANK YOU

Your truck is about to be fitted with the best suspension system on the market today. That means you will be driving the baddest looking truck in the neighborhood, and you'll have the warranty to ensure that it stays that way for years to come. Thank you for choosing BDS Suspension!

BEFORE YOU START

BDS Suspension Co. recommends this system be installed by a professional technician. In addition to these instructions, professional knowledge of disassembly/ reassembly procedures and post installation checks must be known.

FOR YOUR SAFETY

Certain BDS Suspension products are intended to improve off-road performance. Modifying your vehicle for off-road use may result in the vehicle handling differently than a factory equipped vehicle. Extreme care must be used to prevent loss of control or vehicle rollover. Failure to drive your modified vehicle safely may result in serious injury or death. BDS Suspension Co. does not recommend the combined use of suspension lifts, body lifts, or other lifting devices. You should never operate your modified vehicle under the influence of alcohol or drugs. Always drive your modified vehicle at reduced speeds to ensure your ability to control your vehicle under all driving conditions. Always wear your seat belt.

BEFORE INSTALLATION

Special literature required: OE Service Manual for model/year of vehicle. Refer to manual for proper disassembly/reassembly procedures of OE and related components.

Adhere to recommendations when replacement fasteners, retainers and keepers are called out in the OE manual.

Larger rim and tire combinations may increase leverage on suspension, steering, and related components. When selecting combinations larger than OE, consider the additional stress you could be inducing on the OE and related components.

Post suspension system vehicles may experience drive line vibrations. Angles may require tuning, slider on shaft may require replacement, shafts may need to be lengthened or trued, and U-joints may need to be replaced.

Secure and properly block vehicle prior to installation of BDS Suspension components. Always wear safety glasses when using power tools.

If installation is to be performed without a hoist, BDS Suspension Co. recommends rear alterations first.

Due to payload options and initial ride height variances, the amount of lift is a base figure. Final ride height dimensions may vary in accordance to original vehicle attitude. Always measure the attitude prior to beginning installation.

TIRES AND WHEELS

FITMENT GUIDE

7" Lift 2001-07 Classic Body Style

35x12.50 on 16x8 with 4.5" backspacing
37x12.50 on 17/18x9 with 5.5" backspacing - standard
37x12.50 on 20x9 with 5.75" backspacing

7" Lift 2007-10 New Body Style

35x12.50 on 17/18x9 with 5.5" backspacing - standard
35x12.50 on 20x9 with 5.75" backspacing

4.5" Kits

35x12.50 w/ 5" BS Wheel



BEFORE YOU DRIVE

Check all fasteners for proper torque. Check to ensure for adequate clearance between all rotating, mobile, fixed, and heated members. Verify clearance between exhaust and brake lines, fuel lines, fuel tank, floor boards and wiring harness. Check steering gear for clearance. Test and inspect brake system.

Perform steering sweep to ensure front brake hoses have adequate slack and do not contact any rotating, mobile or heated members. Inspect rear brake hoses at full extension for adequate slack. Failure to perform hose check/ replacement may result in component failure. Longer replacement hoses, if needed can be purchased from a local parts supplier.

Perform head light check and adjustment.

Re-torque all fasteners after 500 miles. Always inspect fasteners and components during routine servicing.

CONTENTS OF YOUR KIT

021632 Standard Track Width

Part #	Qty	Description
01178	1	Steering Knuckle - DS
01179	1	Steering Knuckle - PS
568	1	Bolt Pack - CV Spacer
	12	10mm-1.5 x 70mm SHCS
02328	2	CV Spacer
02332	2	Steering Stop

121654

Part #	Qty	Description
03495	1	Lower coilover mount - DRV
03496	1	Lower coilover mount - PASS
03497	1	Upper Coilover Mount - DRV
03498	1	Upper Coilover Mount - PASS
03499	2	Reservoir Brkt
692	1	Bolt Pack - Coilover Mounting
	8	1/2"-13 x 1-1/2" Bolt - Grade 8
	2	1/2"-13 x 2-1/2" Bolt - Grade 8
	2	1/2"-13 x 2-3/4" Bolt - Grade 8
	16	1/2" SAE Thru-Hardened Washer
	4	1/2"-13 Center Lock Nut
	2	5/8"-11 Serrated Edge Flanged Nut
	2	3/4"-10 x 4-1/2" Bolt - Grade 8
	2	3/4"-10 Prevailing Torque Nut
	4	3/4" SAE Washer
Bag Kit	1	Bag Kit
099000	6	11.5" Zip Tie
01642	2	Small 'L' bracket
0708785	2	7/8" x 0.406 mounting hole clamp
01716	2	Offset Brakeline Bracket
768	1	Bolt Pack - Brakeline Bracket
	2	1/4"-20 x 3/4" bolt - grade 5
	2	1/4"-20 nylock nut
	4	1/4" USS flat washer
03502	8	Nut Tab
Bag Kit	1	Bag Kit
02196	2	Aluminum Control Arm Spacer
693	1	Bolt Pack - Main Hardware Kit
	3	1/2"-13 x 1-1/4" Bolt - Grade 8
	3	1/2"-13 x 1-1/2" Bolt - Grade 8
	6	1/2" SAE Thru Hardened Washer
	4	1/4"-20 x 3/4" bolt - grade 5
	2	1/4"-20 x 1/2" bolt - type 23 self threading bolt
	4	1/4" split lock washer
	8	1/4" SAE Washer
	4	1/4"-20 nylock nut
	6	Wire Clamps

121252

Part #	Qty	Description
A305	1	UCA Assembly - DRV
03500	1	Chevy HD UCA - Tubular - DRV
500-1105	1	Ball Joint
01499	1	Nut Spacer Washer
BDS222760	1	BDS UCA Sticker
SB02A241190	2	UCA Bushings
A306	1	UCA Assembly - PASS
03501	1	Chevy HD UCA - Tubular - PASS
500-1105	1	Ball Joint
01499	1	Nut Spacer Washer
BDS222760	1	BDS UCA Sticker
SB02A241190	2	UCA Bushings
B1155	1	Bag Kit - UCA Caps
02911	2	Ball Joint Cap
9452K145	2	O-Ring
099000	2	11.5" Zip Tie - Blk
0708760	2	3/8" x 0.406 Clamp
768	1	Bolt Pack - Cable Clamp
	2	1/4"-20 x 3/4" bolt - grade 5
	2	1/4"-20 nylock nut
	4	1/4" USS flat washer
45NA53	1	Poly Grease Packet

121650

Part #	Qty	Description
02380B	1	HD Front Skid Plate

021442

Part #	Qty	Description
02190B	1	HD Front x-member
02191B	1	HD Rear x-member
02193B	1	HD Diff Tube - Pass Side
A128	1	Sticker Tube
BDS222764	1	3.5 X 12 Silver Sticker
BDS222767	1	2.5 X 40 Silver Sticker
B381	1	Bag Kit - HD Driveshaft Boot Extension
02437	1	HD Driveshaft Boot Extension
9262K821	1	4x42 O-Ring
9452K208	1	#322 O-Ring

Rear Shocks

Part #	Qty	Description
FOX98224759	2	3" Rear Box Kit Shocks
or		
FOX98224761	2	5" Rear Box Kit Shocks

021441		
<i>Part #</i>	<i>Qty</i>	<i>Description</i>
911115	2	sway bar link 10"
539	1	bolt pack
	2	5/8"-11 x 6" bolt grade 8
	2	5/8"-11 x 5" bolt grade 8
	4	5/8"-11 prevailing torque nut
	8	5/8" SAE flat washer thru-hardened
	1	9/16"-12 x 4-1/2" bolt grade 8
	3	9/16"-12 prevailing torque nut
	6	9/16" SAE flat washer thru-hardened
	2	9/16"-12 x 1-1/2" bolt grade 8
	5	10mm-1.50 x 60mm bolt class 8.8 (1 Not Used)
	5	10mm flat washer (1 Not Used)
	2	3/8"-16 standard hex nut (Not Used)
	2	3/8" SAE flat washer (Not Used)
	2	3/8" lock washer (Not Used)
569	1	Bolt Pack - Sway Bar Links
	2	3/8"-16 nylock nut (Not Used)
	2	7/16"-14 nylock nut
	2	9/16"-12 x 2-3/4" bolt
	4	9/16" SAE washer
	2	9/16"-12 prevailing torque nut
	2	5/8"-11 x 1-3/4" bolt
	4	5/8" SAE washer
	2	5/8"-11 nylock nut
973	1	Bolt Pack - Skid Plate Mounting
	8	1/2"-13 x 1-1/2" bolt grade 8 (2 Extra)
	8	1/2" SAE flat washer thru-hardened (2 Extra)
02192B	1	HD Diff Drop - Pass
02194B	1	Diff Skid Plate
01185B	1	Front Diff Brkt
B328	1	Bag Kit
15	1	3/4" X 0.090 X 2.950 Sleeve
01187	1	HD Weld-in Plate
SB35BK	2	Hourglass Bushing - Wide
SB26BK	4	Stem Bushing
S10076	4	Stem Washer
54587	2	3/4" x 9/16" ID x 1.575" Rolled Sleeve
342701	1	Thread Locker
099000	6	11.5" Zip Tie
B329	1	Bag Kit
02102B	2	Offset Sway Bar Bracket
3624BK	2	Front Diff Poly Bushings

Rear Lift Options (1 of 3 Choices)		
<i>Part #</i>	<i>Qty</i>	<i>Description</i>
BDS011319		3" Rear Block Kit
962961212QB	4	9/16" x 2-9/16" x 12-1/2" Square U-Bolts
3KB-W58	2	3" Rear Blocks
B127	1	Bag Kit (3" Block Kit)
N96FH	8	9/16" Fine High Nuts
W96S-B	8	9/16" SAE Washers
OR		
BDS011517		5" Rear Block Kit
962961500QB	4	9/16" x 2-9/16" x 15" Square U-Bolts
BB088	2	5" Flat Block
B138	1	Bag Kit (5" Block Kit)
N96FH	8	9/16" Fine High Nuts
W96S-B	8	9/16" SAE Washers
OR		
BDS001509	2	Rear Leaf Spring
UBT4045	4	9/16" x 2-9/16" x 11-3/8" Sqr. U-Bolts W/ Nuts & Wash.
962961138QB	1	9/16" x 2-9/16" x 11-3/8" Square U-Bolts
N96FH	2	9/16" Fine High Nuts
W96S-B	2	9/16" SAE Washers

Fox 2.5 DSC Front Coilovers		
<i>Part #</i>	<i>Qty</i>	<i>Description</i>
FOX88406188	1	6.5" Fox 2.5" Coilover
or		
FOX88406187	1	4.5" Fox 2.5" Coilover

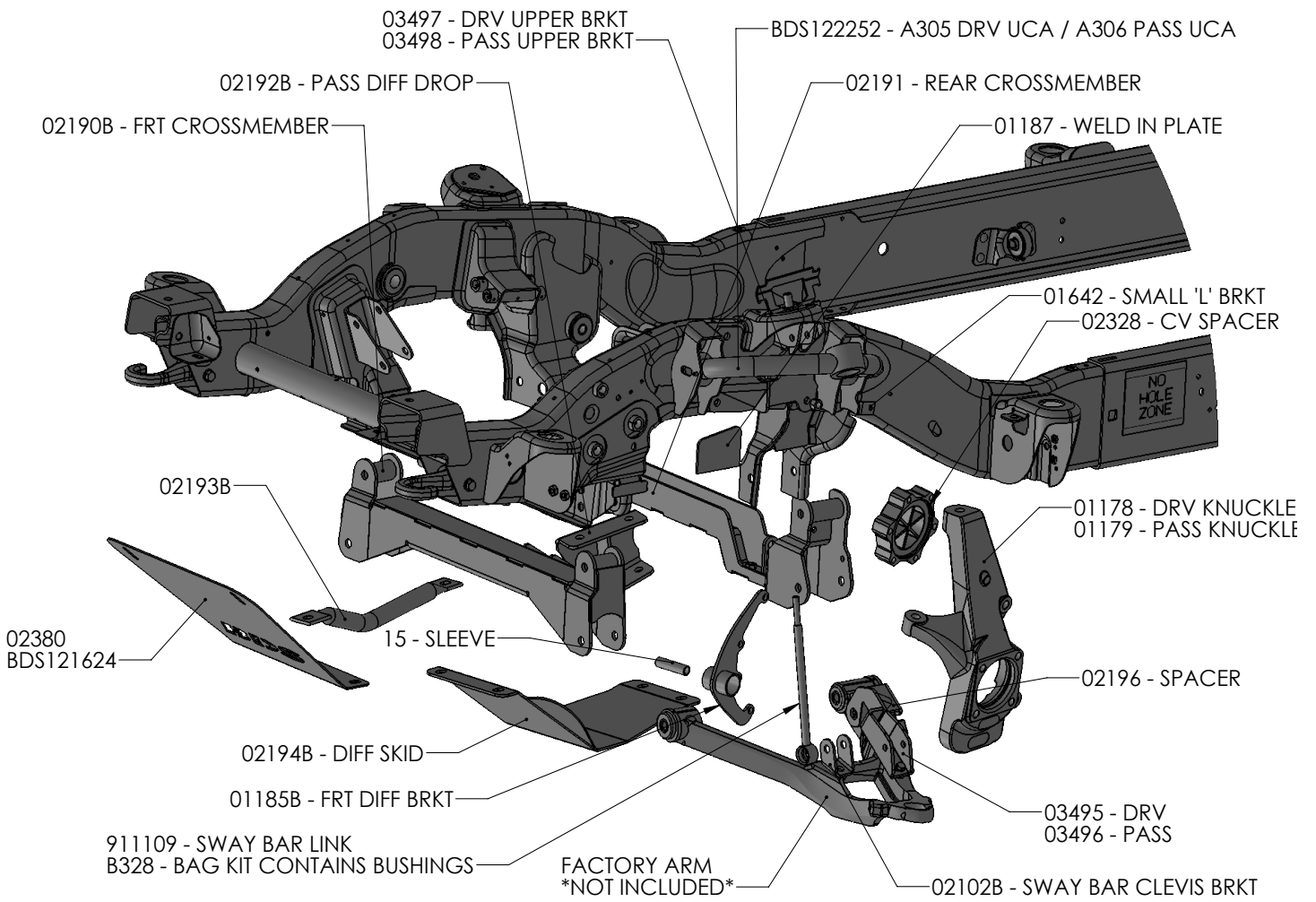

PRE INSTALLATION

IMPORTANT

It is required that ride height measurements be taken before and after installation. Measure from the **WHEEL AXLE CENTER** up to the **FENDER LIP** of the wheel opening. Do this for all 4 wheels. Record measurements below.**

BEFORE

Left Front _____ *Right Front* _____

Left Rear _____ *Right Rear* _____

AFTER

Left Front _____ *Right Front* _____

Left Rear _____ *Right Rear* _____



***These ride heights will be required if you have any ride height concerns after installation. Please be prepared to provide these to Technical Support.*

IMPORTANT NOTES ABOUT THE COILOVER KITS

4.5" Kit: Designed for Diesel applications only. Do not increase preload of coil to have more than 1/2" of exposed thread above the upper coil seat. The jounce bumper on the coilover has a very progressive rate, it will be nearly touching at ride height. This is part of the design of the kit for best ride quality.

7" Kits: Designed for Diesel applications only. Do not increase the preload on the 7" coilover to get additional lift height, the coil spring may go to full coil bind and cause coilover failure. See 4.5" kit notes about jounce bumper above.

Adjusting the DSC (dual speed compression) clickers: Clickers are independent of one another, turning the blue (high speed) will not affect the gold and vice versa. The clickers come preset for optimal ride quality, for heavy off road use, increasing the compression resistance is recommended.

Take care of the shock bodies per the FOX instructions, included in coilover box.

Will not fit GAS models, will only work with Diesel models.

2500 COILOVER UPGRADE INSTRUCTIONS:

Purchase of BDS121654 & BDS 121252 is required, as well as Fox coilovers. Weld on steering stops are also required, contact tech if not present. Follow the disassembly of the torsion bar instructions and remove the no-torsion bar drop brackets from the lower control arm. Once the torsion bars are removed, skip to step #38 Upper Coilover Mount Steps and follow applicable installation steps for coilover installation. System only works with BDS High Clearance Systems that began shipping in 2008 and later (front and rear cross member should look like CAD models on previous page). Use complete instruction sheet as a guide for coilover installation.

TROUBLESHOOTING INFORMATION FOR YOUR VEHICLE

1. 20" wheels with 5" backspacing recommend to reduce trimming.
2. Traction bars will not fit standard cab short box models and are designed to work on vehicles with 4-8" of lift.
3. This is a performance kit, designed for a stock vehicle weight. Heavy plate steel front bumpers are not recommended, aftermarket tube bumpers will typically work well with this system
4. Requires frame bracket and differential mount modification.
5. For tail high stance use 119157 add-a-leaf with the block kit or 069207 with leaf spring kit.
6. Dually applications will require custom u-bolts.
7. For replacement ball joints use service kit BDS081203. Ball joint is directional and must be installed with the 'dot' facing either inward or outward on the vehicle, otherwise damage may occur.



**TECH
TIPS**

INSTALLATION INSTRUCTIONS

INSTALLATION INSTRUCTIONS

1. Park the vehicle on a flat, clean surface and block the rear wheels for safety.
2. Disconnect the positive and negative battery cables.

FRONT INSTALLATION

1. Raise the front of the vehicle and support with jack stands under the frame rails.
2. Remove the wheels.

SPECIAL TOOLS

Torsion Bar Unloading Tool
Reciprocating Saw
Welder

3. Unload the torsion bars but do not remove. Save adjuster bolt/retainer block.
4. Remove the torsion bar adjuster plate by pushing the torsion bar forward to allow the plate to drop free. On most vehicles this will require a using a hammer/punch or air hammer. Access the end of the torsion bar through the hole in the back of the torsion bar crossmember and drive forward. Leave the torsion bars in the lower control arms.



Tip *Torsion bars are under extreme pressure. A proper torsion bar tool is necessary to unload the bars. A tool designed specifically for GM torsion bars (#J36202 or equivalent) is required. Most auto parts store will lend these tools for little or no charge.*

5. Remove the two bolts that attach the torsion bar crossmember to the frame rails (Fig 2). Remove the torsion bar crossmember from the vehicle. Save bolts and crossmember.

FIGURE 2



6. Remove the torsion bars by pulling them rearward out of the lower control arms. Set the torsion bars aside.
7. Remove the front plastic splash guard, save splash guard bolts. If equipped, remove the four bolts mounting the factory belly pan to the frame (Fig 3) These will not be reused.

FIGURE 3

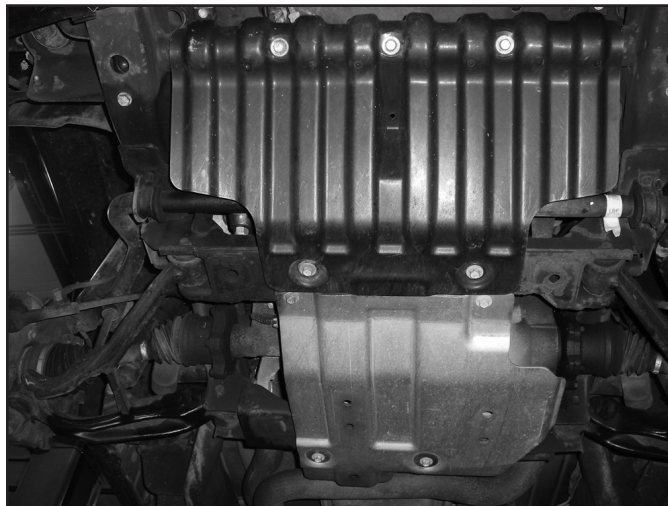

8. Disconnect the sway bar end links from the sway bar and the lower control arms (Fig 4). Discard the link assemblies.

9. Disconnect the tie rod ends from the steering knuckles. Remove the tie rod end nuts and save. Strike the knuckle near the tie rod end to dislodge the tie rod end taper (Fig 4). Remove the tie rod ends from the knuckles.

FIGURE 4

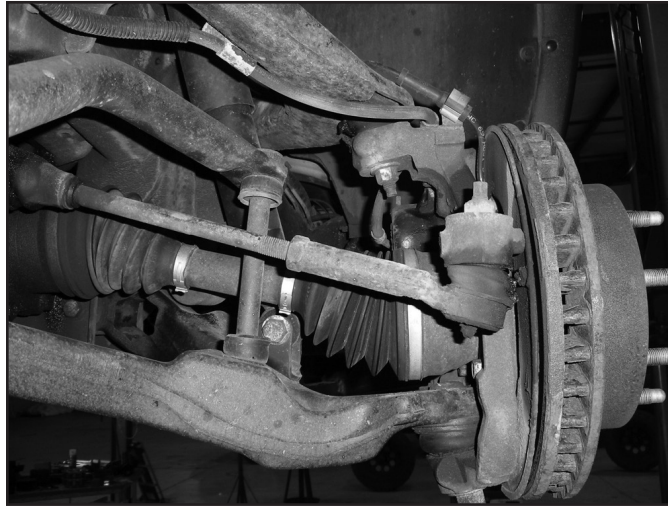

10. Disconnect the ABS brake wire from the connector at the top of the frame (Fig 5) Remove the wire from the plastic retainers on the frame and upper control arm (Fig 6).
11. Disconnect the rubber brake line brackets from the upper control arm and the steering knuckle (Fig 6). Save hardware.

FIGURE 5



FIGURE 6

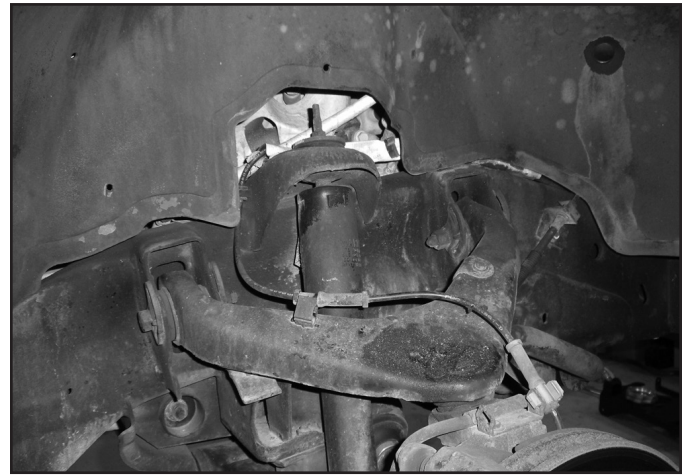

12. Remove the two bolts mounting the brake caliper assembly to the steering knuckle and hang the caliper out of the way (Fig 7). Do not hang the caliper by the brake hose. Save mounting bolts.

FIGURE 7



13. If equipped, remove the rotor retaining clips from the wheels studs. These will not be reused. Remove the brake rotor and set aside.
14. Carefully remove the hub dust cover. Save cover (Fig 8).
15. Remove the CV axle nut and washer. Save hardware.
16. Remove the CV axle flange bolts at the differential (Fig 9). There are 6 bolts per side. Discard the bolts.

FIGURE 8



FIGURE 9



17. Remove the upper ball joint nut. Thread the nut back on by hand one or two turns. Strike the knuckle near the upper ball joint to release the taper. Remove the upper ball joint nut (save) and remove the ball joint from the knuckle. Allow the knuckle to swing out and remove the CV axle from the hub (Fig 10). Mark the CV axle to indicate DRV side and PASS side.

FIGURE 10



18. Remove the lower ball joint nut and thread back on by hand one or two turns. Strike the knuckle near the ball joint to release the taper. Remove the ball joint nut and remove the knuckle from the lower control arm. Save the lower ball joint nut and set the knuckle/hub assembly aside.
19. Disconnect the shocks from the frame and lower control arm. Remove shocks. The shocks and hardware will not be reused.
20. Remove the front and rear lower control arm bolts and remove the control arms from the vehicle (Fig 11) Save the control arms and mounting hardware.

FIGURE 11

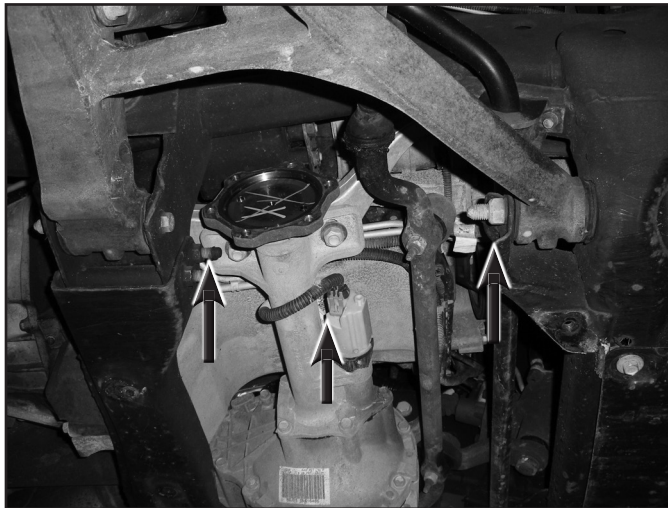

21. Remove the factory bump stops from the frame (Fig 12).
22. Make an alignment mark on the front driveshaft and front differential input yoke. Remove the four bolts/clamps from the yoke and remove the front driveshaft from the differential (Fig 13). Slide the driveshaft out of the transfer case. Save the driveshaft hardware.
23. Remove the four bolts mounting the rear crossmember to the rear lower control arm pockets (Fig 14). Remove the crossmember from the vehicle. The crossmember and hardware will not be reused.

FIGURE 12



FIGURE 13



FIGURE 14



24. Disconnect the electrical connector from the front differential actuator (Fig 11) Remove the wire from the three plastic wire retainers along the top of the differential.
25. Disconnect the axle breather tube from the driver's side of the differential.
26. Loosen but do not remove all of the front differential mounting bolts. There are two on the passenger's side, one on the upper front driver's side and one on the lower rear driver's side.
27. Locate the remaining wing of the rear crossmember on the lower rear driver's side control arm pocket. This portion of the frame must be removed to clear the front differential in its new, lower position. A precise measurement and cut is outlined later in the instructions but to make removing the differential easier the wing portion can be cut off now. Using a reciprocating saw (recommended), hack saw or cut-off wheel, remove the wing just inside of the control arm pocket (Fig 15). Take care not to cut into the differential housing or bolt.

! Caution *Do not use any type of flame cutting as the vehicle undercoating is flammable.*

FIGURE 15



28. Support the front differential with an appropriate jack. Remove the differential mounting hardware and lower the differential from the vehicle and set aside. Save hardware.
29. The lower rear driver's side control arm pocket must be trimmed to provide clearance for the front differential. Measure inward from the lower control arm mounting hole 1-3/4" and mark on both the front and back surfaces of the pocket (Fig 16). Make vertical cut lines at the marks and connect the cut lines along the top surface of the pocket.

FIGURE 16

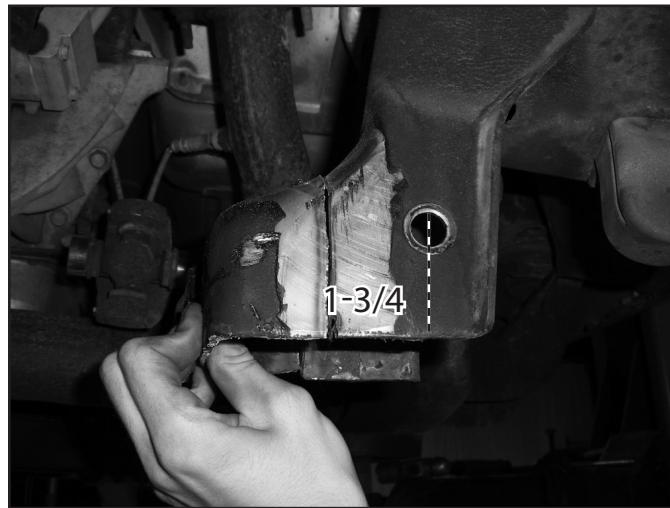

30. Using a reciprocating saw (recommended), hack saw or cut-off wheel, cut the pocket along cut lines.
31. With the control arm pocket trimmed, be sure the area around the cut is free from grease, oil and undercoating. Locate the provided weld-in support plate (01187) and place it up to the frame where the cut was made. The angled edge of the plate goes to the top. Align the top of the plate to the top cut edge of the control arm pocket and center the plate horizontally in the pocket. The bottom edge of the plate must be at least 1/4" above the bottom edge of the factory pocket. Tack weld the plate in place.

! Caution *It is important to completely remove the undercoating from the weld area to avoid weld contamination and keep the undercoating from igniting/melting.*

32. With the support plate tack in place, double check the location and then finish welding it in place (Fig 17). Allow the area to cool slowly and then paint any exposed metal to prevent rust.

FIGURE 17



33. The front upper mount bushing of the differential must be removed to provide adequate steering clearance. Mark a cut line around the mount that is flush with the top of the differential housing. Using a reciprocating saw (recommended) or hack saw, cut the mount off of the differential (Fig 18). Take extra care not to cut into the differential housing.

FIGURE 18



34. Install the provided large bushings (3624RB) and 0.750" OD x 2.950" long sleeve (15) into the eye of the new driver's side differential bracket (01185).
35. Place the driver's side differential bracket up to the front of the differential to indicate the four housing bolts that need to be removed. Remove the four bolts, place the bracket in position and fasten with new 10mm x 60mm bolt and washers (BP 539). Use thread locker on the bolt threads and torque to 30 ft-lbs (Fig 19).

FIGURE 19

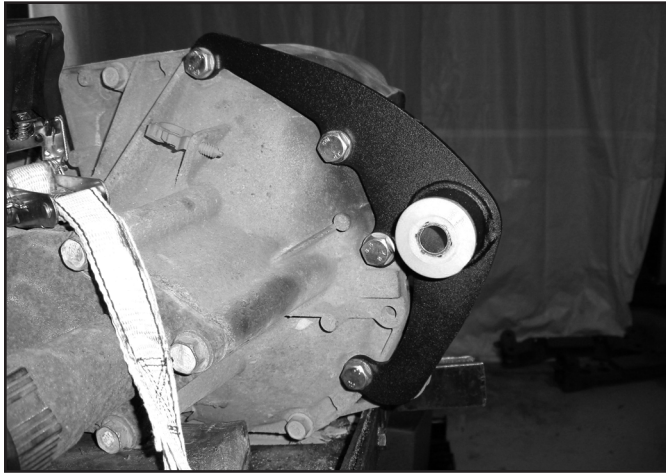

36. Locate the new passenger's side differential bracket (02192). Install the bracket on the existing studs on the passenger's side factory bracket. Fasten with the original nuts and washers. When installed the open side of the bracket will face inward and the bracket will taper down as it goes to the rear (Fig 20). Torque nuts to 65 ft-lbs.

FIGURE 20



37. Inspect the inside factory control arm mounting holes. There will be a sharp lip left from the original control arm/hardware. Use a file or rotary grinder to remove the sharp lip left from the control arms (Fig 21). This will allow the new cross members to be installed easily.

FIGURE 21

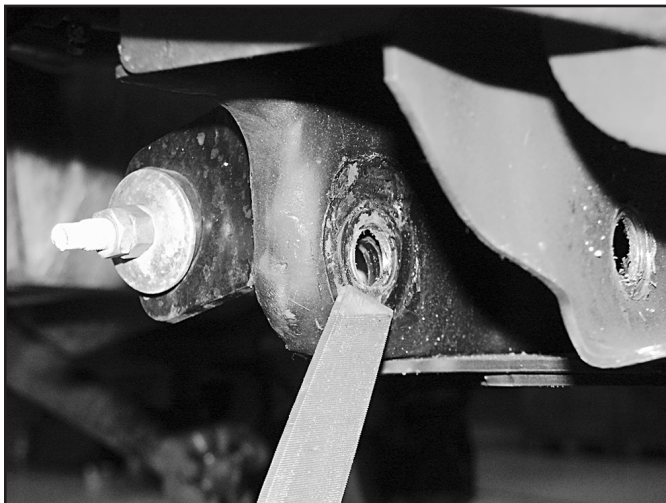

UPPER COILOVER BRACKET INSTALLATION:

38. Remove the upper control arm from the vehicle. Retain upper cam bolts.
39. The factory droop limiter and bump stop must be removed from the vehicle. Use the following figures to reference how to remove the bracket. Grind the side of the frame rail flush. (Fig 22a, 22b, 22c, 22d, 22e, 22f, 22g)

FIGURE 22A

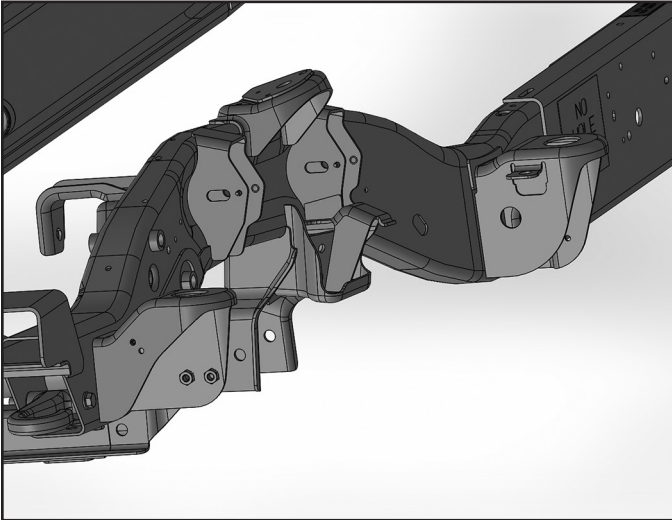

FIGURE 22B (REAR VIEW)

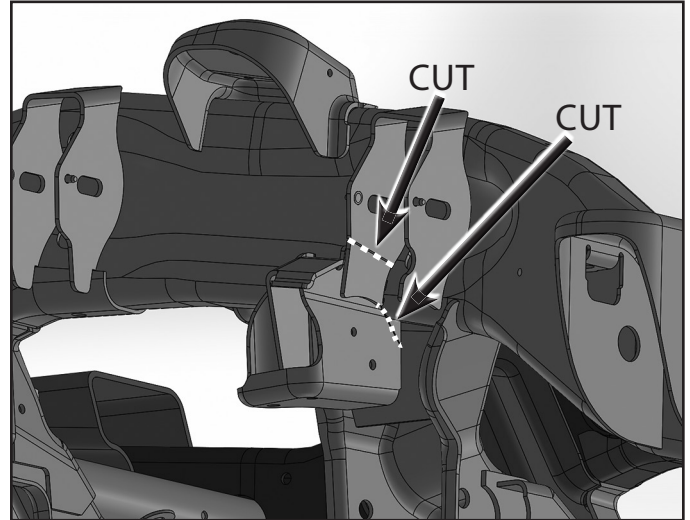

FIGURE 22C (FRONT VIEW)

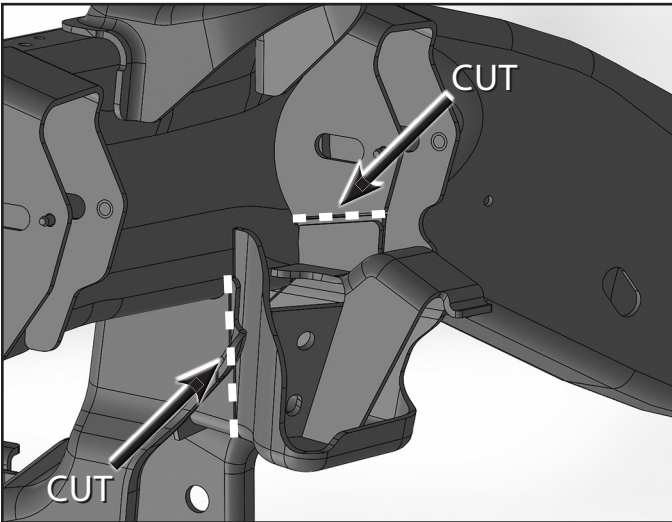

FIGURE 22D (MATERIAL REMOVED)

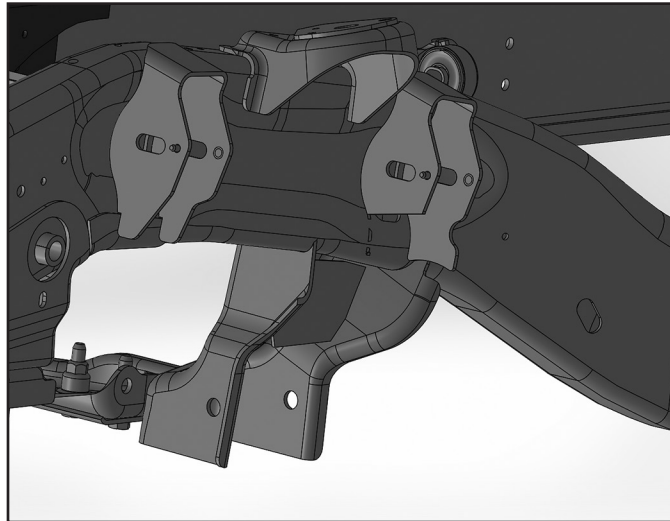

FIGURE 22E

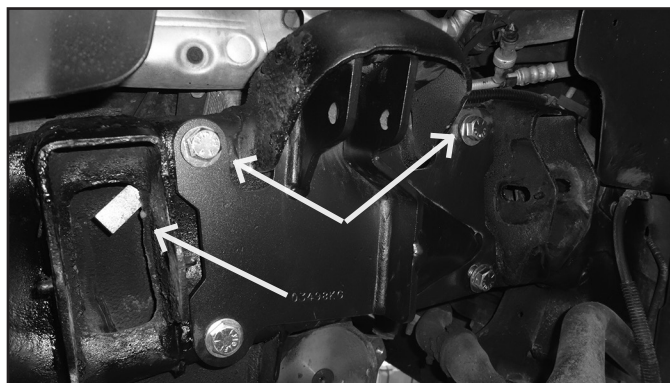

FIGURE 22F



40. Coat frame rail with paint.
41. Place the coilover conversion bracket on the side of the frame rail. Attach to the upper bracket loosely with 5/8" nut. Mark the centers of the holes and remove bracket. Drill holes out to 9/16" (Fig 23)

FIGURE 23



42. Reinstall bracket with 1/2" hardware with nut tabs inside of the frame rail. Attach upper mount with 5/8" serrated edge flanged nut with the reservoir bracket. Tighten 1/2" hardware to 65 ft-lbs, 5/8" nut to 95 ft-lbs.
43. Drill a 5/16" hole on the rear upper control arm bracket as shown. This will get the 'L' bracket and use a clamp to attach the reservoir hose. Now is the easier time to drill the hole. (Fig 24)

FIGURE 24

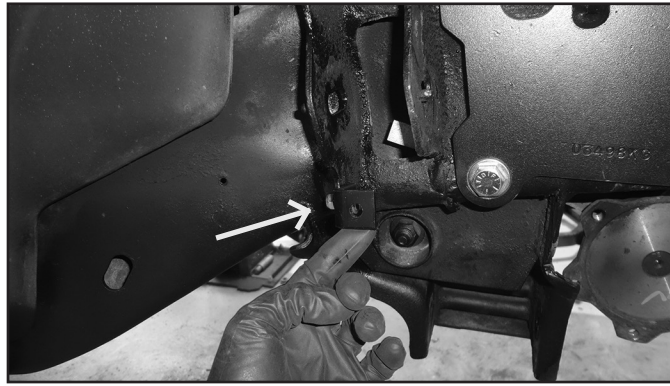

CROSSMEMBER / DIFFERENTIAL INSTALLATION

44. Locate the new front crossmember (02190). Install the crossmember in the front lower control arm pockets so that the two longer differential mounting tabs are on the driver's side pointing rearward (Fig 25). Fasten the crossmember with the original lower control arm hardware. Run the bolts from front to rear. Leave hardware loose.

FIGURE 25

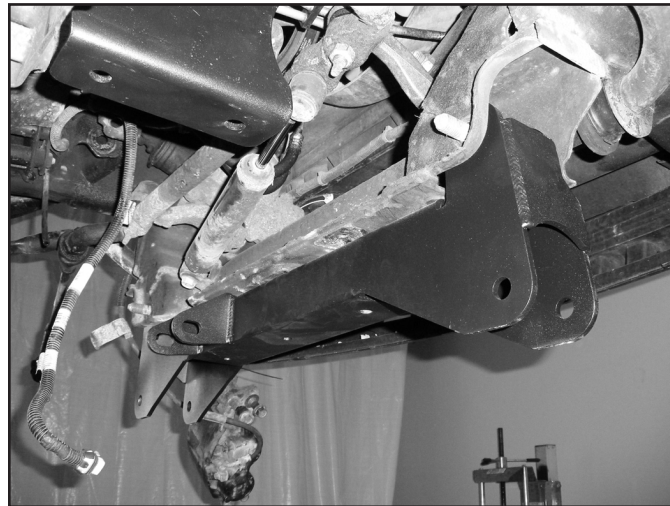

45. Using an appropriate jack, raise the differential up into the vehicle. Align the new driver's side differential bracket in the front crossmember mounting tabs. Align the passenger's side mounting holes to the new bracket (Fig 26). Fasten the driver's side mount with a 9/16" x 4-1/2" bolt, nut and 9/16" SAE washers. Fasten the passenger's side with 9/16" x 1-1/2" bolts, nuts and 9/16" SAE washers (BP 539). Leave the driver's side bolt loose. Tighten the passenger's side bolts just enough to make the two mounting surfaces set flush.

FIGURE 26



46. Install the rear crossmember in the rear lower control arm pockets so that the differential mount lines up with the differential (Fig 27) Fasten the crossmember with the original lower control arm hardware. Run the bolts from front to rear. Leave hardware loose.

FIGURE 27



47. Fasten the differential to the new mount in the rear crossmember with the original rear differential bolt/nut. Run the bolt from the outside in.

LOWER CONTROL ARM COILOVER BRACKETS:

48. Remove the factory shock bracket from the lower control arm. Note: Use caution, because it is easy to snap the bolts with an impact gun.
49. Place the aluminum spacer tube where the OEM torsion bar mounted and place the lower coilover conversion bracket on the arm. Note: The 'flashing / parting line' will need to be ground to get the bracket to line up with the old shock mounts. Use a flap wheel grinder to allow the bracket to fit properly. Aftermarket - Non GM arms may require a lot of modifications to make this happen. (Fig 28a, 28b)

FIGURE 28A

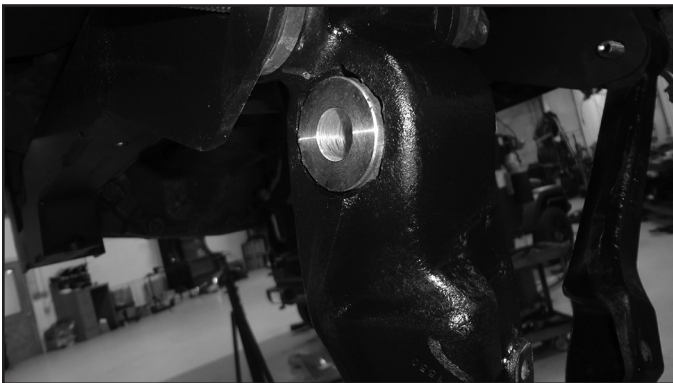

FIGURE 28B



50. Attach bracket to lower arm with 3/4" hardware and OEM 10mm bolts threaded into the OE shock holes. Tighten the two 10mm OE bolts to 35 ft-lbs and the 3/4" provided hardware to 165 ft-lbs.
51. Install the factory lower control arms into the new crossmembers. Fasten the control arms with 5/8" x 5" bolts (front), 5/8" x 6" bolts (rear), nuts and 5/8" SAE washers (BP 539). Run the bolts from the front to rear (Fig 29). Leave hardware loose.

FIGURE 29



52. Go back and torque the four differential bolts to 90 ft-lbs. Torque the factory control arm pocket bolts to 125 ft-lbs. DO NOT tighten the new control arm bolts at this time. This will be done at the end of the installation.

DIFFERENTIAL SKID PLATE INSTALLATION

53. Locate the new differential skid plate (02194). Position the skid plate so that it aligns to holes with the welded nuts on the bottom driver's side of the rear crossmember (Fig 30). Fasten the skid plate with 1/2" x 1-1/2" button head bolts and stainless steel washers (BP973). Snug hardware so the front of the skid plate sets up near the bottom of the front crossmember.
54. Locate the new crossmember support tube (02193). The tube is formed to clear the differential when installed. Position the support tube so it set properly against the bottom of the front and rear crossmembers and aligned to the mounting holes. Fasten the tube to the rear crossmember with a 1/2" x 1-1/2" bolt and washer (BP 973). Again, snug hardware so the tube sets up near the bottom of the front crossmember (Fig 30).

FIGURE 30



55. Locate the new front "BDS" skid plate/splash guard (02319). Loosely attach the skid plate to the original splash guard mounting holes on the upper frame crossmember using the original splash guard bolts. Position the skid plate up to the bottom of the front crossmember "sandwiching" the support tube and differential skid plate. Fasten the front skid plate, differential skid plate and support tube to the front crossmember with 1/2" x 1-1/2" button head bolts and stainless steel washers (BP 571) in the welded nuts in the crossmember (Fig 31). Apply thread locker to the bolt threads and torque to 55 ft-lbs.

FIGURE 31

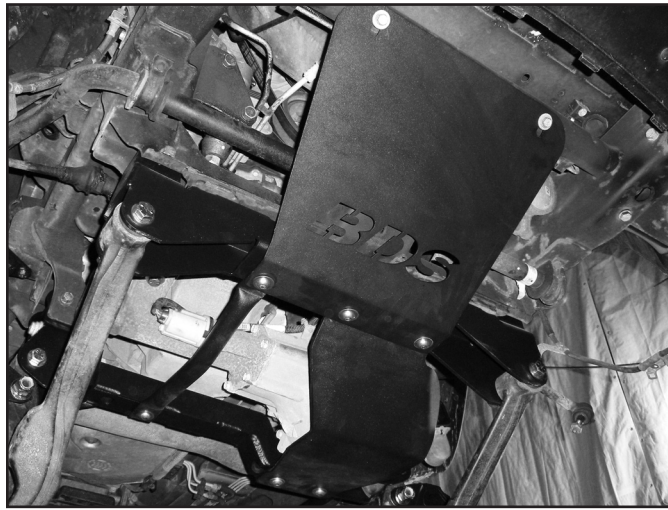

COILOVER INSTALLATION:

- 56. Install coilovers side specific as indicated with sticker. The hose will run towards the REAR of the vehicle. Attach with shorter 1/2" bolts with center lock nut at the top, longer at the lower mount. It will be necessary to squeeze the mounting locations with pliers to get them to fit into the mating brackets. Torque 1/2" hardware to 80 ft-lbs.
- 57. Attach the hose to the 'L' bracket with 7/8" ID Rubber coated clamp with 1/4" hardware. (Fig 32a,32b)

FIGURE 32A

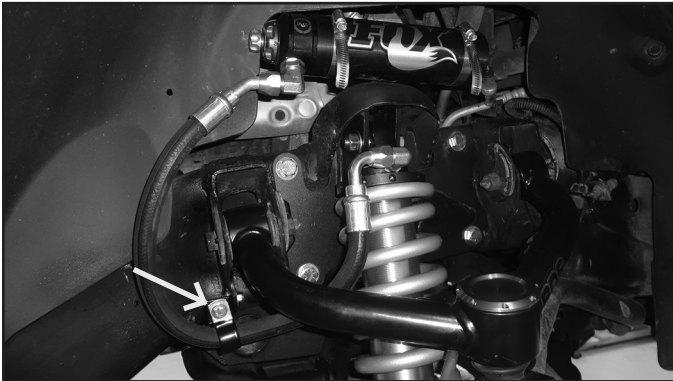

FIGURE 32B



- 58. Attach the reservoir to the reservoir bracket with the hose clamps included in the kit.

UPPER CONTROL ARM INSTALLATION:

- 59. Install upper control arms with factory cam bolts. Run the front bolt from front-rear and the rear bolt from rear-front. Note this is NOT the same as the OE setup. Center the cams and tighten snugly.
- 60. Before attaching arm to the steering knuckle. Thread the 1/4" self threading bolt into the hole on the bottom side of the control arm. It will be difficult to do this later. Remove the bolt for reinstallation later. (Fig 33)

FIGURE 33



61. Ensure the brake line is below the upper control arm, and above the sway bar.
62. Do NOT install the upper ball joint caps at this time!

KNUCKLE ASSEMBLY:

63. With the front hardware tight, remove the rear button head bolts one at a time and apply thread locker to the threads. Reinstall and torque to 55 ft-lbs. Torque the front factory splash guard bolts to 25 ft-lbs.
64. Remove the hub bearing and brake dust shield from the factory steering knuckles (Fig 34). Be sure to note which hub goes on which side of the vehicle. Locate the hub o-ring inside the knuckle hub bore. Using a small flat head screw driver remove the o-ring for use in the new knuckle (Fig 35). Save mounting bolts, o-ring, dust shield and hub, discard the knuckle.

FIGURE 34



FIGURE 35



65. Locate the new steering knuckles and identify the driver's and passenger's side. Install the appropriate knuckle on the lower control arm and fasten with the original lower ball joint nut. Swing the knuckle up and attach to the upper ball joint with the new nut with 1/4" thick spacer washer.
66. Install the factory hub o-ring into the new knuckle hub bore. Install the hub on the appropriate new knuckle so that the ABS line runs out under the steering arm (front - Fig 36A). Fasten the hub with the factory bolts. Apply thread locker to the bolt threads and torque to 133

ft-lbs.



Tip *The original brake dust shield will not be used.*

FIGURE 36A



FIGURE 36B

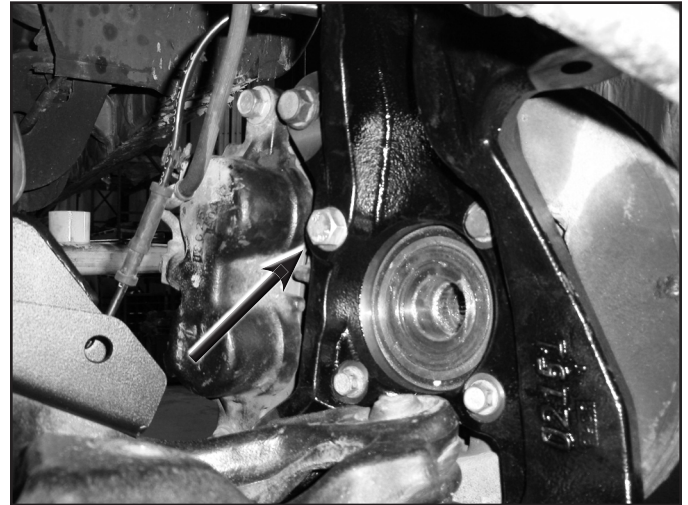

67. Locate the provided "L" shaped weld-on steering stop. Position the stop on the factory steering stop on the front of the lower control arm. The new stop should set flush to the top and square stop surface on the side of the arm. Turn the knuckle so it hits the stop. It should hit square on the new extension. Once the correct position is found, remove the paint on the top surface of the control arm to be welded. Tack weld the stop in place (Fig 37). Double check position by turn the knuckle to hit the stop and then weld the stop in place along the top surface of the control arm.

FIGURE 37



68. Install the brake rotor on the hub. Install the brake calipers on the knuckles with the original bolts. Apply thread locker to the bolt threads and torque the bolts to 125 ft-lbs. Be sure the brake hose is running under the upper control arm and behind the steering knuckle.
69. Install the appropriate CV axle shaft through the hub. Install the original CV axle nut and washer and torque to 155 ft-lbs. Reinstall the hub dust cap.
70. Position the provided CV spacer (02328 - Standard) between the CV shaft and the differential mounting flange (Fig 39). Fasten the CV and spacer to the differential flange with 10mm x 70mm socket head cap screws for standard track systems. Use thread locker on the bolt threads and torque to 45 ft-lbs using a crossing pattern.

FIGURE 39



BRAKE LINE / ABS WIRE ROUTING

71. Factory brakeline metal brackets must be removed from the brake lines (2 plc / line). Use a cut off wheel and a lot of caution and pliers to remove them without damaging the brakelines.
72. Install the offset brakeline bracket at the frame to shift the mounting point 'rearward' on the vehicle. Reattach with OE hardware to frame, and use 1/4" nut on the oem stud. (Fig 40a)

FIGURE 40A



FIGURE 40B



73. Attach the brakeline to the upper arm with 1/4" hardware and rubber coated clamp at the welded on bracket. Attach with 1/4" self threading bolt to the boxed gusset near the upper ball joint. Attach to the steering knuckle with 1/4" self threading bolt. Ensure that the brake line does not rub anything and that there will be adequate slack through wheel travel. (Fig 40b)
74. Attach ABS wire to the backside of the knuckle, use zip ties to keep the ABS wire from rubbing any components.

DRIVESHAFT BOOT EXTENSION INSTALLATION:

75. Remove the factory clamp and boot from the front driveshaft. Locate the driveshaft boot extension and o-rings. Install the o-rings into the appropriately sized grooves in the extension. Apply grease to the o-rings and slide the extension over the driveshaft with the large diameter first until o-ring snaps over the factory boot lip. (Fig 42)



Tip *It is a tight fit over the splines. Re-install the boot on the extension with the factory clamp.*

FIGURE 42



76. Slide the driveshaft into the transfer case and reattach it to the differential with the original clamps/bolts. Torque bolts to 19 ft-lbs.
77. Reconnect the differential actuator wire to the actuator and fasten the wire to the differential in the original plastic clips.
78. Pull the necessary slack down for the differential breather hose to reconnect to the breather on the driver's side of the differential.
79. Install the provided offset sway bar link u-bracket (02102) on the lower control arm in the original sway bar link hole with a 5/8" x 1-3/4" bolt, nut and washers (BP 569). Position the bracket so that it offsets in toward the center of the vehicle (Fig 43a). In some cases it may be necessary to slightly clearance to hole for the 5/8" hardware.

FIGURE 43A



80. Locate the new front sway bar links (911115), small hourglass bushings (SB35BK) and 0.750" OD x 1.575" long sleeves (54587). Install the bushings and sleeves into the eyes of the links. Install the links into the new brackets on the lower control arms with 9/16" x 2-3/4" bolts,

nuts and washers (BP 569). Run the bolts from front to rear and leave hardware loose (Fig 43b).

FIGURE 43B

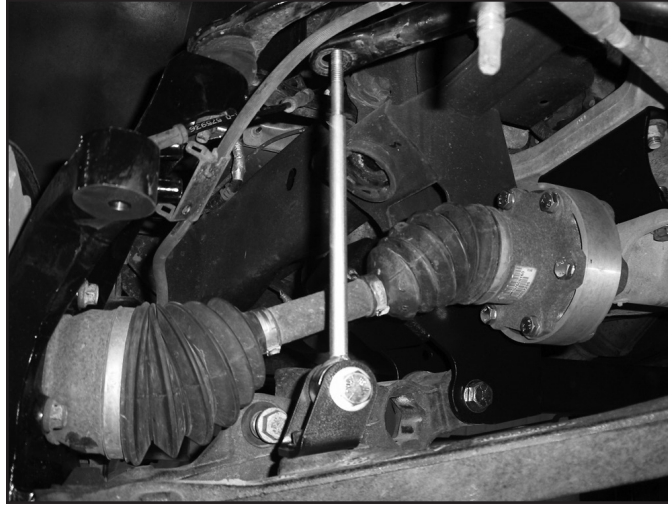

81. Install a provided stem washer (S100776) followed by a stem bushing (SB26BK) on each sway bar link. Install both links into the sway bar and install a second stem bushing followed by a second washer. Fasten the sway bar link upper assemblies with 3/8" nylock nuts (BP 569). Leave nuts loose (Fig 44).

FIGURE 44



82. Attach the tie rod ends to the knuckles. Fasten with the original nuts and torque to 37 ft-lbs.
83. Grease the new upper ball joints at this time.
84. Use provided grease packet to grease the o-ring and install onto the ball joint cap. Grease upper control arm lightly to allow the cap to pop in, press firmly and squarely to get it to seat. (Fig 45)

FIGURE 45

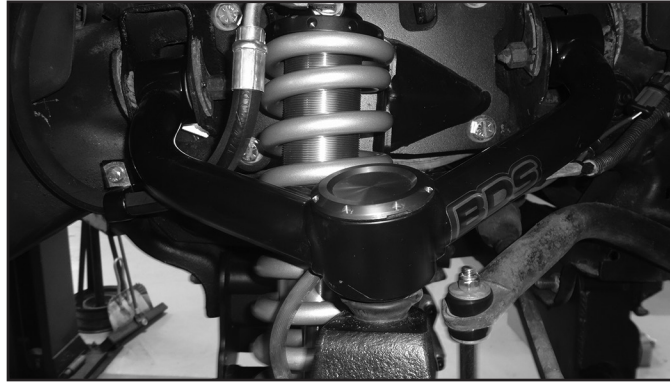

85. Install the front wheels. Torque the lug nuts to 140 ft-lbs. Lower the vehicle to the ground.
86. Bounce the front end to settle the suspension.
87. Tighten the upper sway bar link stem nuts until the bushings begin to swell. Torque the lower sway bar link bolt to 90 ft-lbs.
88. Torque the lower control arm bolts (4) to 125 ft-lbs.
89. Center the upper cams and tighten the upper control arm cam bolts to 65 ft-lbs.
90. Check all front hardware for proper torque.
91. Check all brake lines for proper clearances, cycle steering at full droop. Adjust as necessary.
92. Check tire/wheel clearance with the fenders/bumper as well as with the steering knuckle. It is not uncommon to trim the lower plastic valance of the bumper slightly to add proper tire clearance while turning.
93. Check brake line for proper clearance again at ride height, cycle steering and make any necessary adjustments to keep the brake line from rubbing / touching any components.

REAR INSTALLATION

1. Block the front wheels for safety. Raise the rear of the vehicle and support with jack stands under the frame rails, just ahead of the front leaf spring hangers.
2. Remove the wheels.
3. Disconnect the parking brake cable brackets (2) from the driver's side frame rail (Fig 46) Save all hardware.

FIGURE 46



4. Disconnect the factory brake line bracket attached driver's side frame rail. The nut is accessed on the outside of the frame (Fig 47).

FIGURE 47



5. Support the center of the axle with a hydraulic jack. Remove the factory shocks from the axle and frame. Save hardware and discard shocks.

LIFT BLOCK INSTALLATION

6. With the axle still well support remove the passenger's side u-bolts. The u-bolts will not be reused. Slowly lower the axle and remove the factory block from the axle. The factory block will not be reused.
7. Lower the axle just enough to install the new provided 5" lift block between the axle and the spring. Align the pin in the block with the hole in the axle and the hole in the block with the leaf spring pin. It may be necessary to loosen the driver's side u-bolts slightly to allow the axle to lower far enough to install the block.
8. Using the support jack, raise the axle so that the axle, spring and block are all touching. Install the new provided u-bolts, nuts and washers allow with the factory u-bolt plate (Fig 48). Snug u-bolts but do not tighten.

FIGURE 48

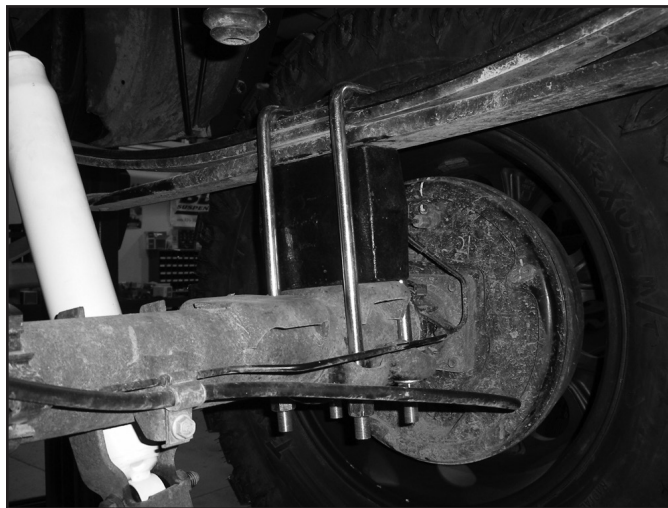

9. Repeat the installation on the driver's side of the vehicle. Pay special attention to all of the brake lines and wires. Do not allow them to get over-extended.

SPRING INSTALLATION

10. Lower the axle from the spring. Remove the front spring hanger bolt and rear spring shackle-to-frame bolt. Remove the spring from the vehicle.
11. Lightly grease and install the provided bushings and sleeves in the new BDS leaf springs.
12. Remove the shackle from the factory springs and loosely install it on the corresponding end of the BDS spring.
13. Install the new spring in the vehicle with the factory hardware. Leave hardware loose.
14. Using the support jack, raise the axle so that the axle and spring are touching and align the spring center pin in the hole in the axle. Install the new provided u-bolts, nuts and washers allow with the factory u-bolt plate. Snug u-bolts but do not tighten.
15. Repeat the installation on the driver's side of the vehicle. Pay special attention to all of the brake lines and wires. Do not allow them to get over-extended.

SPRING AND BLOCK INSTALLATION

16. Locate the brake line clamp bolt on the driver's side axle shock mount. This bolt must be trimmed flush with the inside surface of the bracket to avoid contact with the new shock (Fig 49). Trim the bolt with a reciprocating saw or cut-off wheel.
17. Locate the new shocks/bushings/sleeves. Install the provided hourglass bushings and sleeves in the new shocks. Install the shocks in the vehicle with the original hardware. The body of the shock must be mounted to the axle. In some cases the axle shock brackets will need to be bent open slightly to provide clearance for the new, wider shocks. This can be easily done by putting an adjustable wrench on side of bracket that needs to be formed and bending out just enough to clear the shock body. Torque shock bolts to 70 ft-lbs.
18. Reattach the parking brake cable brackets to the driver's side frame rail. It may be necessary to remove the driver's side cable from the rear most bracket to allow for enough slack. Torque bracket bolts to 20 ft-lbs.
19. Locate and remove the factory bump stops from the driver's and passenger's frame rails (Fig 47). Save hardware.
20. Install the factory bump stops on the new provided bump stop spacer (01196B) with the factory hardware. The bump stop will mount to the spacer on the face with 3 holes. Tighten hardware securely.

FIGURE 49



21. Install the extended bump stops to the original holes on the frame with the 3/8" hardware in bolt pack 422. Install the bump stops so the open face of the extension is toward the inside of the vehicle (Fig 50). Torque bolts to 25 ft-lbs.
22. On the driver's side, attach the factory brake line bracket to the hole in the new bump stop extension with the original hardware (Fig 51). Torque nut to 25 ft-lbs.

FIGURE 50



FIGURE 51

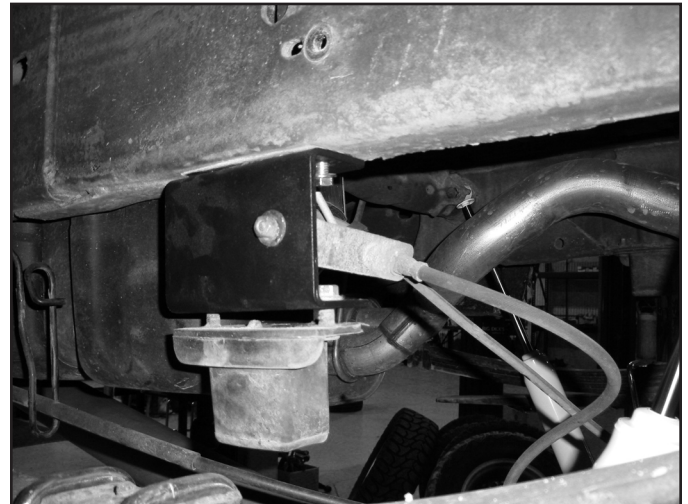

23. Install the wheels. Torque lug nuts to 140 ft-lbs. Lower the vehicle to the ground.
24. Bounce the rear of the vehicle to settle the suspension.
25. Torque the u-bolts to 90-100 ft-lbs.
26. Check all rear hardware for proper torque.

POST-INSTALLATION

1. Check all hardware for proper torque.
2. Reconnect the positive and negative battery cables.

FINAL CHECK

3. The vehicle will need a complete front end alignment.
4. Check all hardware after 500 miles.
5. Grease the ball joint at regular service intervals.
6. Adjust headlights.



WE WANT TO SEE YOUR RIDE!

Grab photos of your BDS-equipped truck in action and send them in for a chance to be featured. Send it in to our Bad Ass Rides customer gallery at bds-suspension.com/bar and post them on the BDS Fan Page on Facebook at facebook.com/BDSSuspensions. Don't forget about your BDS swag! BDS offers t-shirts, hoodies, decals and more available on the BDS website or through your local BDS distributor.

TIME TO HAVE SOME FUN

Thank you for choosing BDS Suspension.

For questions, technical support and warranty issues relating to this BDS Suspension product, please contact your distributor/installer before contacting BDS Suspension directly.