

Installation Instructions

I - Sheet Number HUSKYASK02 Rev.D



Aeroskin II™

**For proper installation and best possible fit, please read all instructions BEFORE you begin.
For technical assistance or to obtain missing parts, please call Customer Relations at 1-800-344-8759.**

Important Safety Information



- CAUTION - Before driving, ensure that the Aeroskin is properly secured to vehicle.
- Do not use automatic "brush-style" car washes.
- Do not use cleaning solvents of any kind.
- Periodically check all components for tightness.

Contents

NOTE: Actual product may vary from illustration.

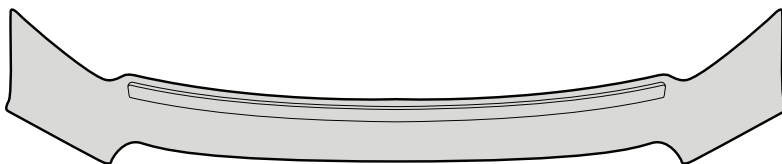

Aeroskin II



Alcohol Pad x2

Tools Required



Car Wash Supplies



Clean Towel

Preparation Before Painting / Installation

- A trial fit is recommended to ensure proper positioning and fit.
- Check fit of parts before painting as we will not accept the return of modified or painted parts.
- Wash and dry your vehicle to remove any debris and/or dirt from the installation area.

NOTE: Ensure vehicle surface and part are between 60°F and 80°F (15°C and 27°C) prior to installation.

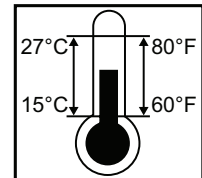

Do not drive vehicle for 24 hours after installation.



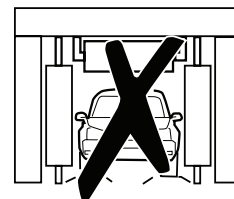

Do not wash vehicle for 72 hours after installation.



Installation Steps

NOTE: Actual application may vary slightly from illustrations.

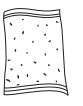
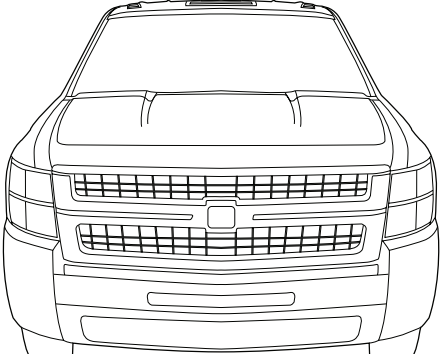
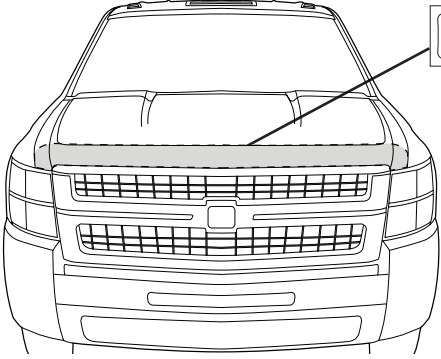
	<p>Prior to installation, wash the hood of vehicle and dry with a clean cloth.</p>		<p>Use the alcohol pads to clean the entire LEADING EDGE of the hood.</p>
			
<p>1</p>		<p>2</p>	

Expose 2" (5 cm) of tape liner from each section of Aeroskin. Ensure you can access the free ends of tape liner.
NOTE: Inspect part thoroughly to confirm all sections of tape liner are exposed.

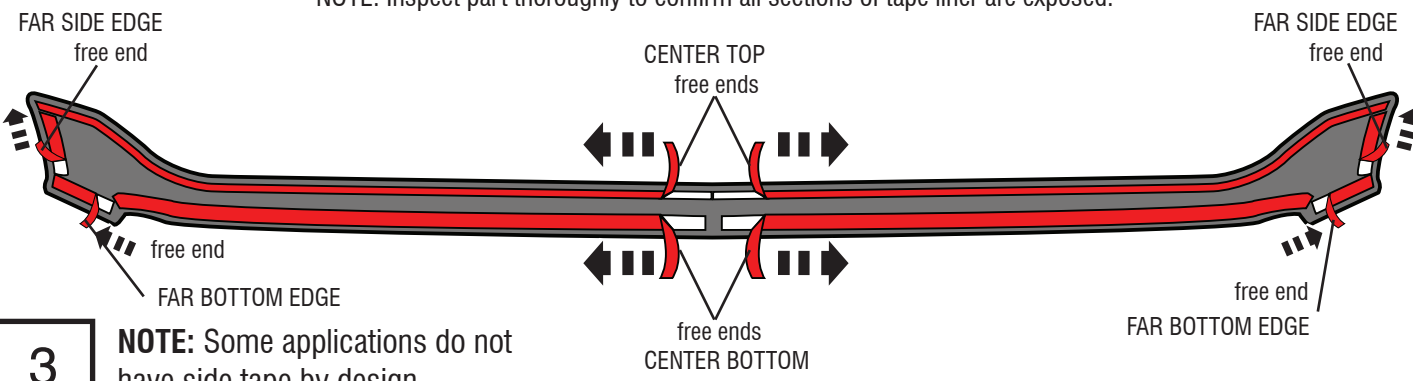

3 **NOTE:** Some applications do not have side tape by design.

Center the Aeroskin on the hood. Part should be positioned about 1/16" (1.5mm) from hood edge on all sides.

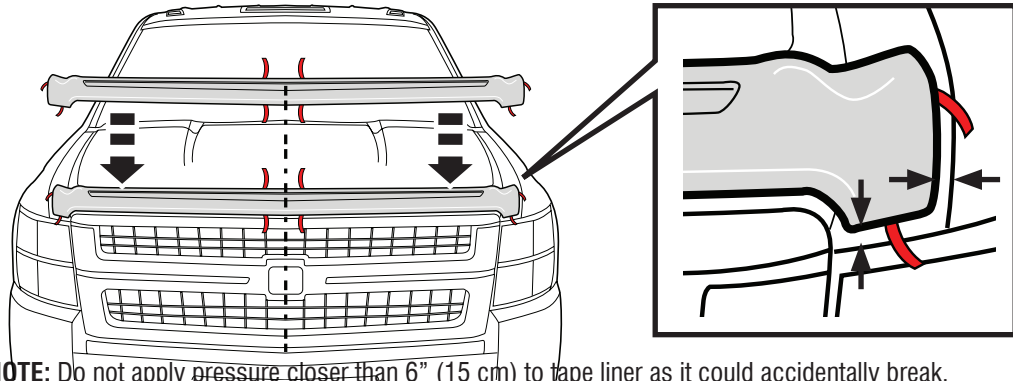

4 **NOTE:** Do not apply pressure closer than 6" (15 cm) to tape liner as it could accidentally break.

Begin removing remaining tape liner, beginning with the drivers side CENTER TOP. Grasping the free end, pull tape gently in 6" (15 cm) sections, while applying even pressure with hand to Aeroskin. Repeat process for passenger side.

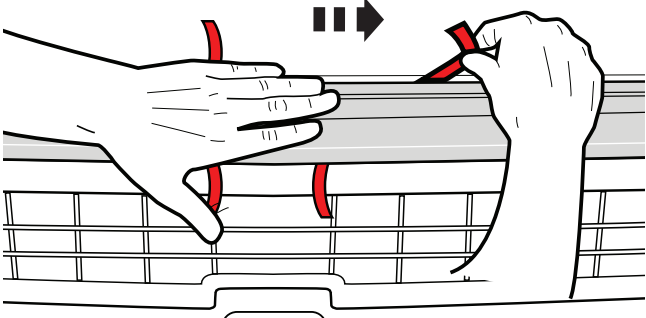

5 **CAUTION:** You must apply even pressure **from center section out** to each end of part, in order for proper adhesion to hood.

Installation Steps

NOTE: Actual application may vary slightly from illustrations.

Using the same process, remove tape liner from the driver side CENTER BOTTOM of hood skin. Repeat for passenger side.

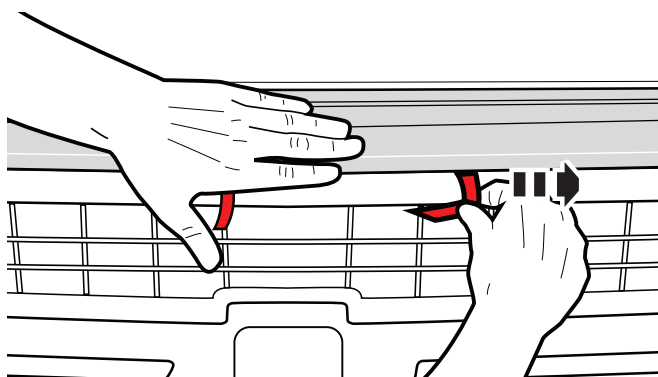

CAUTION: You must apply even pressure **from center section out** to each end of part, in order for proper adhesion to hood.

6

Again using the same process, remove tape liner from the driver side FAR SIDE EDGE of Aeroskin. Repeat for passenger side.

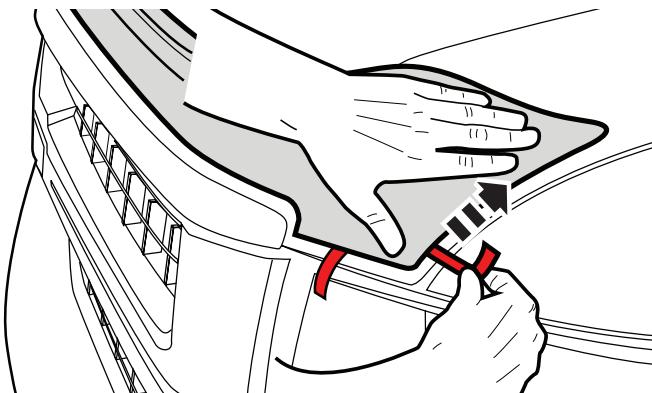

NOTE: Some applications do not have side tape by design.

7

Again using the same process, remove tape liner from the driver side FAR BOTTOM EDGE of hood skin. Repeat for passenger side.

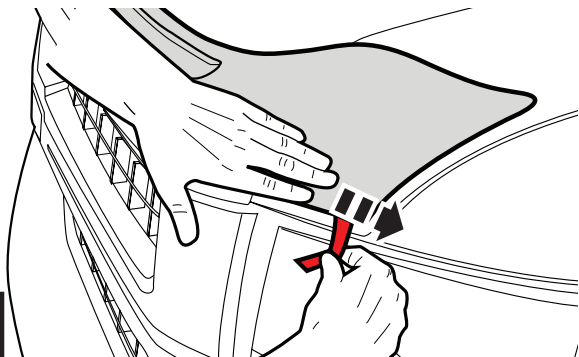

8

Press firmly along all edges of Aeroskin to ensure adhesion of tape to hood surface.

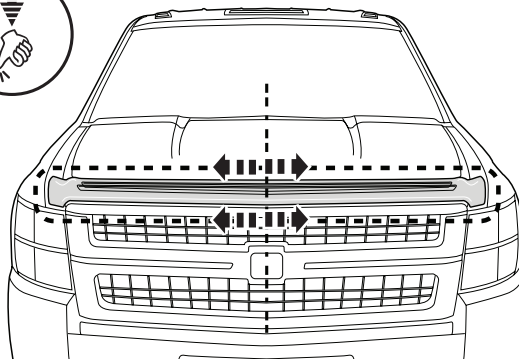

9

Care and Cleaning

- Wash only with mild soap & dry with a clean cloth.



The material that your product is made from can be recycled. Please also consider recycling the packaging that your product came in.



Congratulations!

You have purchased one of the many quality Husky® branded products. We take the utmost pride in our products and want you to enjoy years of satisfaction from your investment. We have made every effort to ensure that your product is top quality in terms of fit, durability, finish and ease of installation.



1-800-344-8759 • Visit us at huskyliners.com

© 2023 Husky Liners, Inc. All rights reserved.

Husky® and the Husky® logo are trademarks of Husky Liners, Inc.