



FITTING INSTRUCTIONS

Part Number: **3421530 / 3421540**
Fitting kit No: **6174125/6174126**
Product **ARB WINCH BULL BAR**
Description:
Suited to **TOYOTA 4 RUNNER YEAR MODELS 03 ON**
vehicle/s:

WARNING

REGARDING VEHICLES EQUIPPED WITH SRS AIRBAG:

When installed in accordance with these instructions, the front protection bar does not affect operation of the SRS airbag.

ALSO, NOTE THE FOLLOWING:

- ◆ This product must be installed exactly as per these instructions using only the hardware supplied.
- ◆ In the event of damage to any bull bar component, contact your nearest authorised ARB stockist. Repairs or modifications to the impact absorption system must not be attempted.
- ◆ Do not use this product for any vehicle make or model, other than those specified by ARB.
- ◆ Do not remove labels from this bull bar.
- ◆ This product or its fixing must not be modified in any way.
- ◆ The installation of this product may require the use of specialized tools and/or techniques
- ◆ It is recommended that this product is only installed by trained personnel
- ◆ These instructions are correct as at the publication date. ARB Corporation Ltd. cannot be held responsible for the impact of any changes subsequently made by the vehicle manufacturer
- ◆ During installation, it is the duty of the installer to check correct operation/clearances of all components
- ◆ Work safely at all times
- ◆ Unless otherwise instructed, tighten fasteners to specified torque

ARB 4x4 ACCESSORIES

Corporate Head Office

42-44 Garden St
Kilsyth, Victoria
AUSTRALIA 3137

Tel: +61 (3) 9761 6622
Fax: +61 (3) 9761 6807

Australian enquiries
North & South American enquiries
Other international enquiries

sales@arb.com.au
sales@arbusa.com
exports@arb.com.au

www.arb.com.au

GENERAL CARE AND MAINTENANCE

By choosing an ARB Bar, you have bought a product that is one of the most sought after 4WD products in the world. Your bar is a properly engineered, reliable, quality accessory that represents excellent value. To keep your bar in original condition it is important to care and maintain it following these recommendations:



- Prior to exposure to the weather your bar should be treated to a Carnauba based polish on all exposed surfaces. It is recommended that this is performed on a six monthly basis or following exposure to salt, mud, sand or other contaminants.
- As part of any Pre Trip Preparation, or on an annual basis, it is recommended that a thorough visual inspection of the bar is carried out, making sure that all bolts and other components are torqued to the correct specification. Also check that all wiring sheaths, connectors, and fittings are free of damage. Replace any components as necessary. This service can be performed by your local authorised ARB stockist.

FITTING REQUIREMENTS

REQUIRED TOOLS FOR FITMENT OF PRODUCT:

Metric socket and spanner sets 8-25mm range	External Circlip pliers
Screwdrivers Philips and Flat blade	Cold chisel
Hammer	
Power Drill 13mm capacity	10mm and 13mm drill bits

HAVE AVAILABLE THESE SAFETY ITEMS WHEN FITTING PRODUCT:

Protective eyewear		Hearing protection	
--------------------	---	--------------------	---

NOTE: 'WARNING' notes in the fitting procedure relate to OHS situations, where to avoid a potentially hazardous situation it is suggested that protective safety gear be worn or a safe work procedure be employed. If these notes and warnings are not heeded, injury may result.

FASTENER TORQUE SETTINGS:

SIZE	Torque Nm	Torque lbft
M6	9Nm	4lbft
M8	22Nm	16lbft
M10	44Nm	32lbft
M12	77Nm	57lbft

OPTIONAL LIGHT SETS TO SUIT THIS PRODUCT:

- ◆ ARB 6821201 FOG LAMP SUIT 3163015
- ◆ Up to IPF 900 SERIES FOG OR DRIVING LIGHT SETS

PARTS LISTING

APPLICATION.	PART NO.	QTY	DESCRIPTION
Mount Assembly To Chassis	3756893	1	Bracket Mount Assembly
	3756851R	1	Bracket Mount Brace RHS
	3756851L	1	Bracket Mount Brace LHS
	3193741	2	Captive Nut Plate
	6151306	2	Nut Cage M12 x 1.75
	6151255	8	Bolt M12 x 1.75 x 40mm
	6151189	6	Nut M12 x 1.75
	6151094	2	Bolt M12 x 1.25 x 30mm
	4581049	18	Washer Flat M12
	4581050	10	Washer Spring M12
5846401	4	Spacer 8mm	
Bull Bar To Mount Bracket Assy	6151357	10	SEMS Bolt M10 x 1.5 x 30mm
	4581040	10	Washer Flat M10 x 2mm
	6151026	10	Nut M10 x 1.5
Stone Tray to Bull Bar	6542091	1	Stone Tray
	6151300	4	Nut Cage 6mm
	6151213	4	Bolt M6 x 20mm
	4581084	4	Washer Flat M6
	4581287	4	Washer Spring M6
Indicators To Bull Bar	3163015	1	Combination Light Surround Kit
	6821152	2	Turn signal / clearance light loom
	180701	6	Scotch lock
	6821192	2	Bulb 12V 10W BA15S
	6821151R	1	Turn Signal / Clearance Light
	6821151L	1	Turn Signal / Clearance Light
Winch To Bull Bar	EG50	1	Rubber Grommet
	3756499	1	Bracket Control Box
	6151021	2	Bolt M8 x 20mm
	4581044	2	Washer Flat M8
	6151132	2	Nut Flange M8
	BLB560	2	Cable Black 560mm
	4581040	4	Washer Flat M10 x 2
	6151074	2	Bolt 1 3/4" x 3/8" UNC
Buffers to Bull Bar	3162470R	1	Buffer
	3162470L	1	Buffer
	6151128	12	Nut M6 Flanged
Number Plate To Bull Bar	6821189	2	Grommet Nylon Nut
	6151384	2	Screw
	6781408	1	Tape Double sided
Wing Under Panel Kit (3421540 only)	6151132	10	Nut Flange M8x1.25P
	6151234	10	Bolt M8x1.25x25 BZ
	4581045	10	Washer Flat M8x17x1.2 BZ
	6522670R	1	Panel Washer Bottle Guard RH
	6522670L	1	Panel Washer Bottle Guard LH
Miscellaneous	6821132	2	Rubber Grommet 3/8" ID
	180302	8	Cable Ties
	3162152	2	Plastic Plug 16mm DIA

FITTING PROCEDURE



1. Undo bumper light electrical connections and then remove front bumper cover from vehicle

NOTE: For 03-05 Models only, follow steps 2 to 4 and 42 to 44 regarding plastic trim support.

2. Remove plastic support from inside OE bumper cover.



3. With trim piece fitted to OE bumper cover as shown, mark out and draw a line 25mm (1") from the leading edge of the lower grille trim approx. 864mm (34") long



4. Remove trim and then cut out plastic panel along marked line from OE bumper fascia, set this piece aside for fitting later.



5. Remove trim piece and support bracket
6. With trim piece removed, mask the area around the headlight and the front guard and paint the lower section under the front guard black.

FITTING PROCEDURE



7. Remove front bumper reinforcing bar.
NOTE: Retain the 8 x flange nuts removed for fitment of the bull bar chassis mount.



8. Remove front fasteners only from stone tray. Retain fasteners for reuse.



9. Using the 13mm drill bit and power drill, drill out the M8 captive nut located at the outboard side of the chassis as shown, on both sides of the vehicle.



Warning: Drilling operations can result in flying metal debris, safety glasses should be worn.



10. Check that the nut body is completely removed, if it is not cleared, using a cold chisel and hammer chisel the remainder off.



Warning: Hammering and chiselling operations can result in flying metal debris, safety glasses should be worn.

FITTING PROCEDURE



11. Fit an M12 cage nut to each of the captive nut plates 3193741.

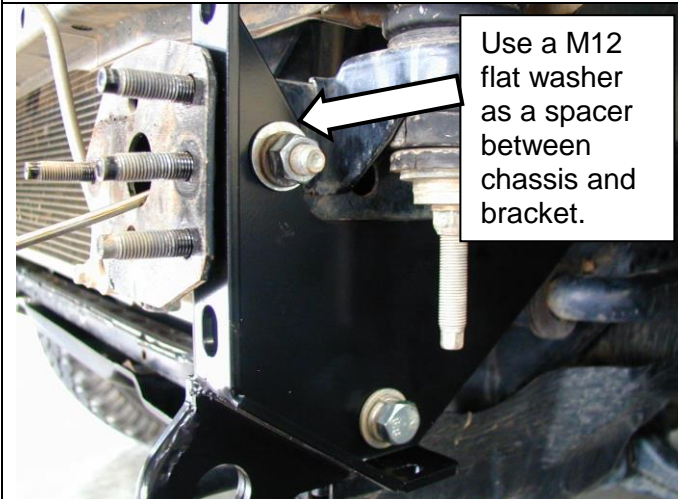

12. Fit the chassis mount braces to the vehicle using the M12 x 30mm fine pitched bolt, M12 spring and flat washers supplied in the lower hole. Use an M12 flat washer as a spacer between the brace and the chassis at the upper hole and fix with an M12 x 40mm bolt M12 spring and flat washers and M12 x 1.75 nut. Do not tighten the bolts.



13. Insert the captive nut assembly through the front of the chassis and line it up with the hole at the end of the mount brace. Fix in place with the M12 x 1.75 x 40mm bolt, M12 flat and spring washers. Break off the end of the captive nut plate. Do not tighten yet.

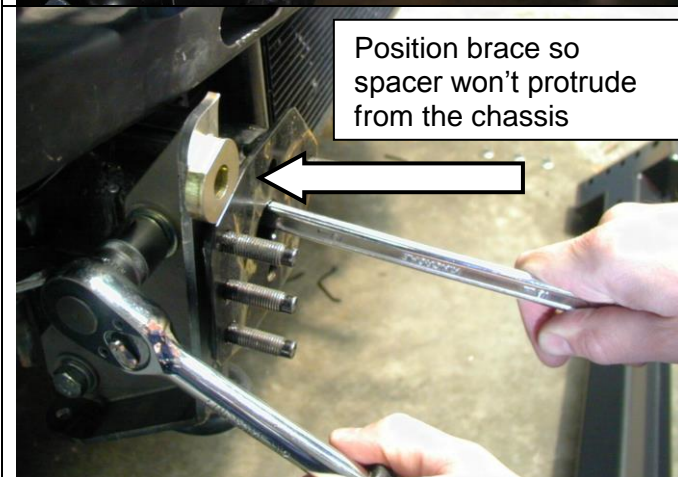

14. Hold the 8mm spacer against the chassis mount brace forward facing surface and position the brace so that the spacers sit just below the surface of the chassis front face. Tighten the bolts.

FITTING PROCEDURE



15. Fit the chassis mount bracket to the chassis using the original flange nuts removed with the bumper reinforcing bar. Centre the chassis mount bracket and tighten.

CAUTION: When fitting the Chassis mounting bracket carefully bend the air-conditioning pipe out of the way.



16. If required, carefully bend piping clear of mount bracket assembly.

CAUTION: Piping must not rub on sharp edges, secure with cable tie and protective sheath if required.

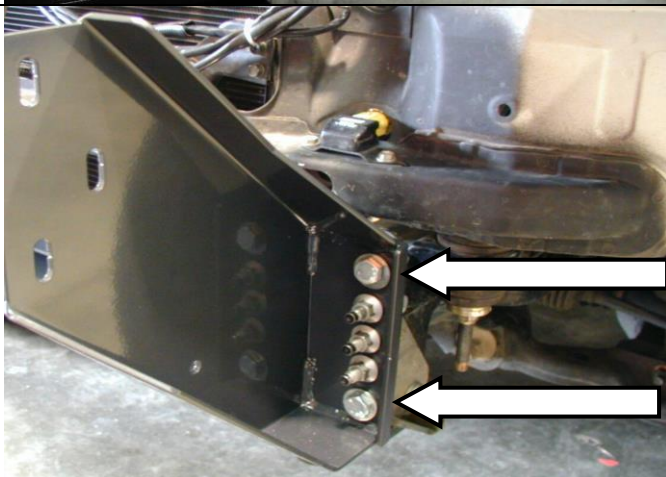

17. Fix the chassis mount bracket to the chassis mount brace using M12 x 40mm bolts, M12 spring and flat washers, the 8mm spacers and M12 x 1.75 nuts. Tighten bolts

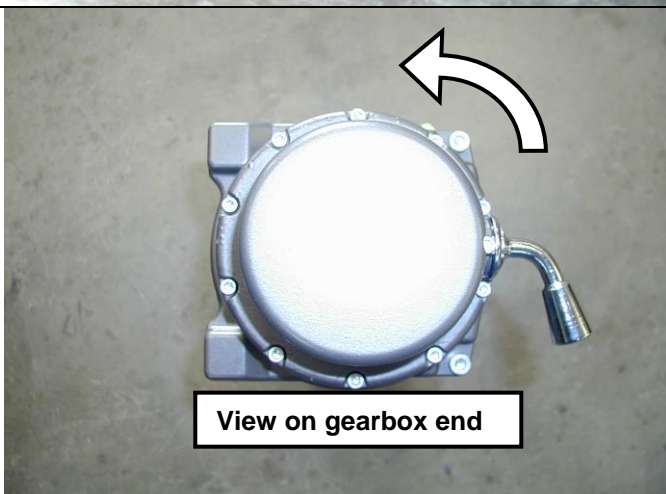

NOTE: If fitting winch continue through step 18, if not skip to step 30

18. For ease of access the winch gearbox handle needs to be rotated. To do this undo all the cap screws, carefully lift the gearbox clear of the winch body so as not to damage the gasket. (Do not lift the gearbox more than a couple of millimetres) Rotate the gearbox anti-clockwise three hole spaces. Re-fit the caps-crews.

FITTING PROCEDURE

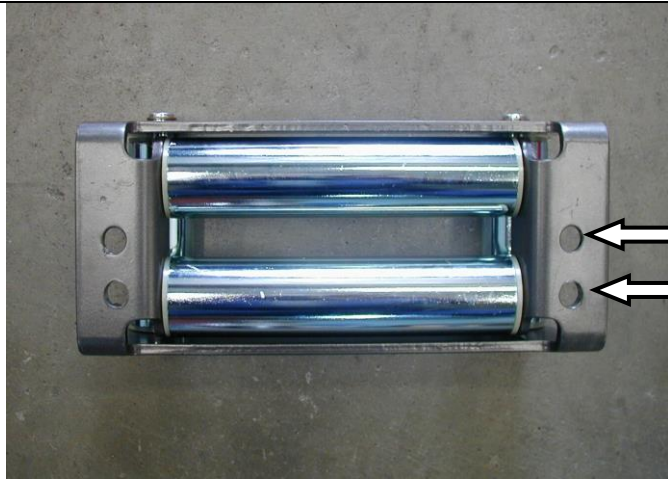

19. Using a 12mm drill bit, drill two new holes in the roller fairlead 25mm below the original holes.

Original hole.

New hole 25mm lower.



Warning: Drilling operations can result in flying metal debris, safety glasses should be worn.

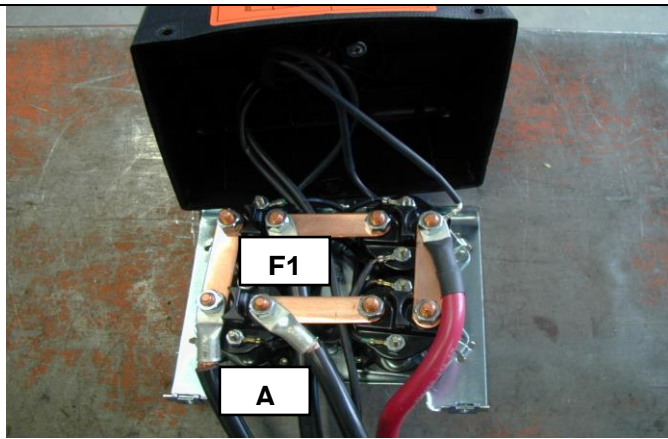

20. Remove the three screws from the control box and remove the cover.
21. Replace the two cables marked "A" and "F1" and replace them with the two cables (BLB560) supplied with the fitting kit. Label the cables the same as the original to assist in the wiring of the winch.



22. Place the winch on a table with the feet facing up and using an assistant; carefully lift the bull bar on top of the winch.
23. Attach the winch to the bull bar using two 1 1/2" x 3/8" bolts from the winch fitting kit, 3/8" spring washer and 3/8" flat washers in the top holes.
24. Fit the 4 x M6 cage nuts from inside of the lower flange on the pan, where the stone tray will bolt up.

NOTE: Access to this area for cage nut fitment will be restricted once the RFL is fitted so it is important to insert these now.



25. Position the roller fairlead, and remove the circlips from the lower of the vertical rollers and push the pins up to give access to the lower bolts.
26. Fix the roller fairlead to the bar using the 1 3/4" x 3/8" bolts, spring and flat washers

FITTING PROCEDURE



27. Fit the control box bracket to the bull bar using two M8 x 20mm bolts, M8 flat washers and M8 flange nuts.



28. Fit the control box to the control box bracket and connect the power cables to the winch as per the winch instructions.
29. Connect the ground wire to the tension bar of the winch.

CAUTION: Cable-tie all cables together and keep all cables clear of sharp edges and all moving parts.



30. Insert square grommets into holes in front of bar for number plate fixing. Place the double-sided tape along the top edge of the number plate. Using supplied black screws, attach the number plate to the bull bar.

NOTE: If winch is not fitted, number plate can be located lower on bar front to cover RFL opening.



31. Fit the buffers to either side of the bull bar using 6 x M6 flange nuts. Do not over tighten.

FITTING PROCEDURE



32. With the help of an assistant position the bull bar on the chassis bracket and fix with six M10 x 30mm bolts, M10 spring and flat washers.

CAUTION: Nip up bolts, but do not tighten them yet.



33. Position the bull bar so that there is an even gap of approximately 20-25mm from the top face of the bar to the underside of the body edge. Then tighten all the bolts.



34. With the bull bar in position drill Dia10mm pinning holes, one though pilot hole in mount bracket and one through hole in upright for both sides of mounts.



Warning: Drilling operations can result in flying metal debris, safety glasses should be worn.

35. Fix in place using two M10 x 30mm SEMS bolts, M10 Flat washers and M10 x 1.5 nuts per side.



36. Fit the bull bar stone tray by sliding the tray under the front of the vehicles original stone tray and fixing in place with the original bolts from the vehicles stone tray.

37. Fit the front of the stone tray to the bull bar with four M6 x 20mm bolts, M6 large panel washers and M6 spring washers.

FITTING PROCEDURE

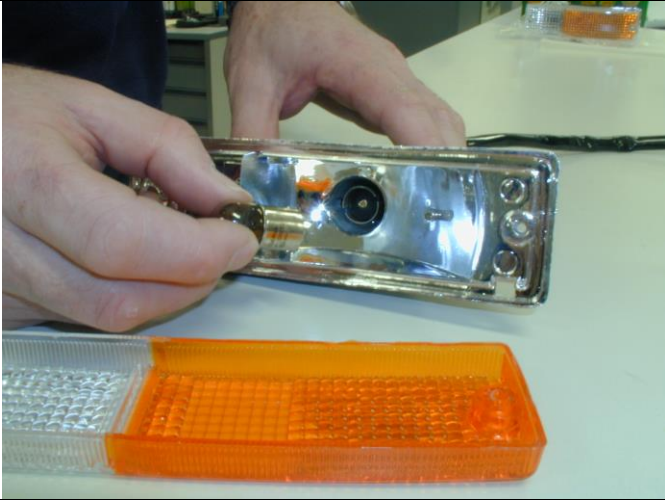

38. Replace 21W light bulbs for indicator (yellow reflector side) in supplied indicator/run lamp assemblies with 10W bulbs from fitting kit.

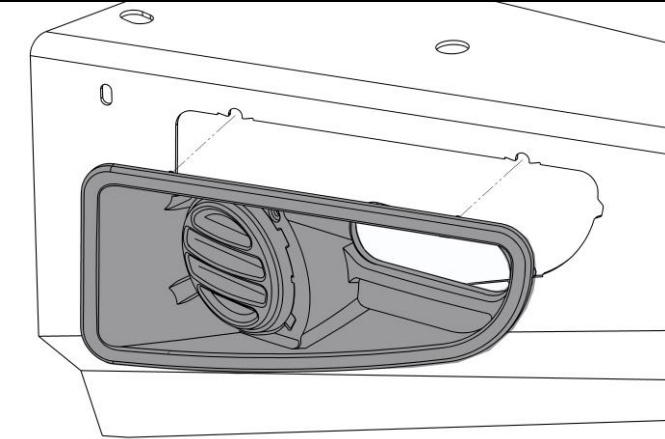

39. Assemble and install combination light surrounds (p/n 3163015) as per instructions no. 3786421 supplied with surround kit. Note: Optional fog lamps can be installed at this point as per fitting instruction no. 3783315 supplied with fog lamp kit 6821201



40. Wire up indicator and run lights using loom extensions supplied in fitting kit.
- NOTE: The 4 Runner has a two wire circuit for indicators. The bull bar indicator and run lamps each side are to be wired to operate in parallel. ARB supplied wiring loom has Red and Green for power to indicator and run lamps – join these wires together. Other wiring detail supplied with accessories.**

Toyota 4 Runner wiring colors:

RH White w/Black Stripe – Ground
Red w/Yellow stripe - Power

LH White w/Black Stripe – Ground
Red w/Green stripe - Power

FITTING PROCEDURE

3421540 ONLY

41. Fit wing underpanels using panels and M8 fasteners supplied

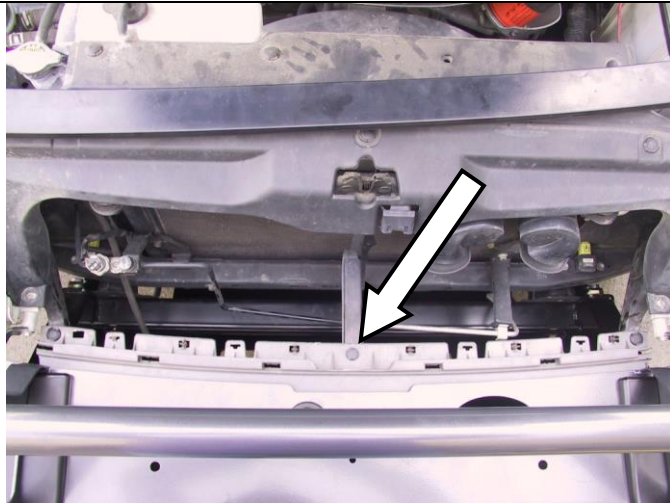

42. Take cut out trim from OE bumper (Step 4) and tuck leading edge of plastic trim under back edge of bumper and use OE retaining clips in the OE holes to hold bumper piece into place



43. Snap lower grille trim into place onto bumper piece.



44. Finished install of trim piece.

- ***When finished make sure all bolts are tightened and that all wiring is clear of hot, sharp and moving parts.***
- ***Also supplied in the kit are two 3/8" rubber grommets and two 16mm plugs. The rubber grommets are for the two holes in the top pan if lights are being fitted. The two plastic plugs are for the holes in the top surface of the wings if no CB aerials are going to be connected.***
- ◆ ***NOTE: Fog lamps shown fitted to bull bar below are optional accessories, ARB P#9249FCK 100mm 55WATT FOG LAMP KIT***

