

ROUGH COUNTRY

SUSPENSION SYSTEMS®

GM 2016-18 1500 Lowering Knuckle 2/4 Kit

Thank you for choosing Rough Country for all your suspension needs.

Rough Country recommends a certified technician install this system. In addition to these instructions, professional knowledge of disassemble/reassembly procedures as well as post installation checks must be known. Attempts to install this system without this knowledge and expertise may jeopardize the integrity and/or operating safety of the vehicle.

Please read instructions before beginning installation. Check the kit hardware against the kit contents list on the back page. Be sure you have all needed parts and know where they go. Also please review tools needed list and make sure you have the tools needed to install the kit.

PRODUCT USE INFORMATION

⚠ WARNING

Generally, braking performance and capability are decreased when larger/heavier tires and wheels are used. Take this into consideration while driving. Do not add, alter, or fabricate any factory or after-market parts to decrease vehicle height over the intended height of the Rough Country product purchased. Mixing component brands is not recommended.

Rough Country makes no claims regarding lowering devices and excludes any and all implied claims. We will not be responsible for any product that is altered.

We will be happy to answer any questions concerning the design, function, and use of our products.

⚠ NOTICE

NOTICE TO DEALER AND VEHICLE OWNER

INSTALLING DEALER / OWNER - It is your responsibility to install the warning decal and forward these installation instructions on to the vehicle owner for review. These instructions should be kept in the vehicle for its service life.



Tools Needed:
 24mm Wrench
 22mm Wrench
 21mm Wrench
 18mm Wrench
 17mm Wrench
 16mm Wrench
 15mm Wrench
 13mm Wrench
 12mm Wrench
 10mm Wrench
 8mm Allen Wrench
 Drill Motor
 Drill Bit 11/32
 Drill Bit 15/32
 Vise Grips
 Die grinder
 Floor Jack
 Jack Stands



FRONT INSTALLATION INSTRUCTIONS

1. Lift the front of the vehicle using a jack and support the vehicle with jack stands, so that the front wheels are off the ground
2. Remove the front tires/wheels., using a 21mm deep well socket
3. Starting on the driver side, remove the ABS sensor bracket from the top of the knuckle using a 10mm socket. **See Photo 1.** Next remove the ABS wire from the plastic clip. Remove the bracket from the control arm using a 10mm wrench. **See Photo 2.**

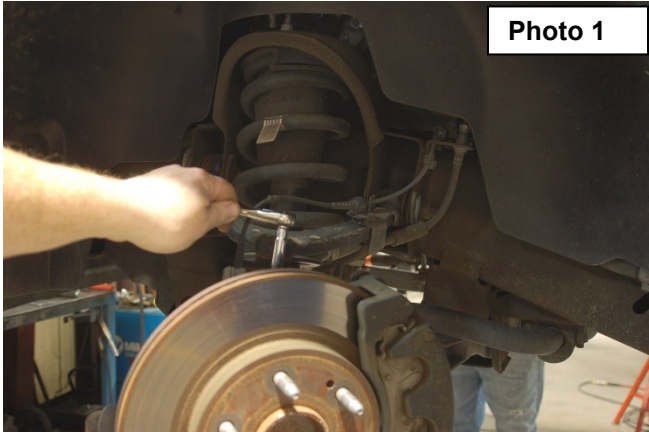

Photo 1

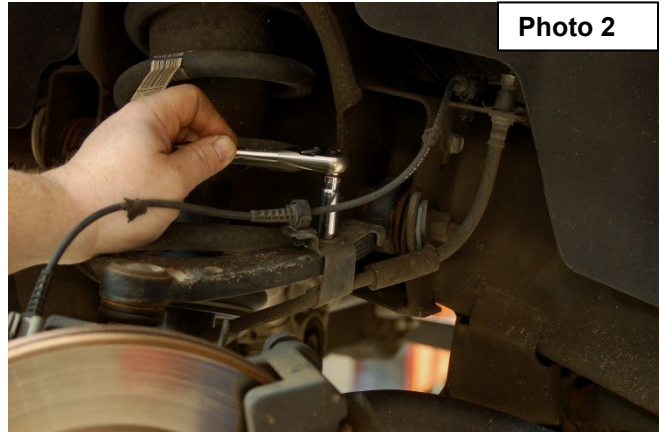

Photo 2

4. Using a 21mm wrench remove the tie-rod nut and strike the side of the mount to dislodge the taper lock on the tie-rod. **See Photo 3.**
5. Remove the brake caliper from the factory knuckle using a 18mm socket. **See Photo 4.** Hang caliper out of the way.

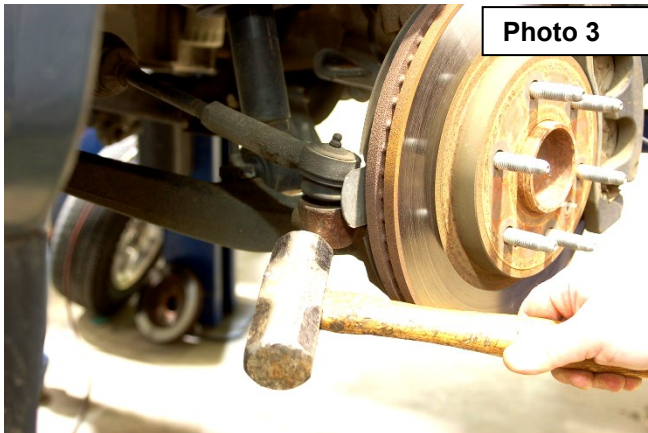

Photo 3

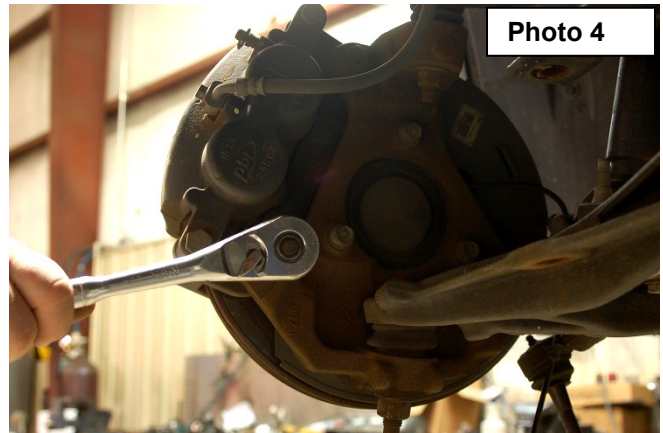

Photo 4

6. Remove the ABS sensor from the bearing assemble using a 8mm allen wrench. **See Photo 5.**
7. Remove the upper ball joint nut using a 18mm wrench, strike the knuckle on the side to dislodge the ball joint. **See Photo 6.**

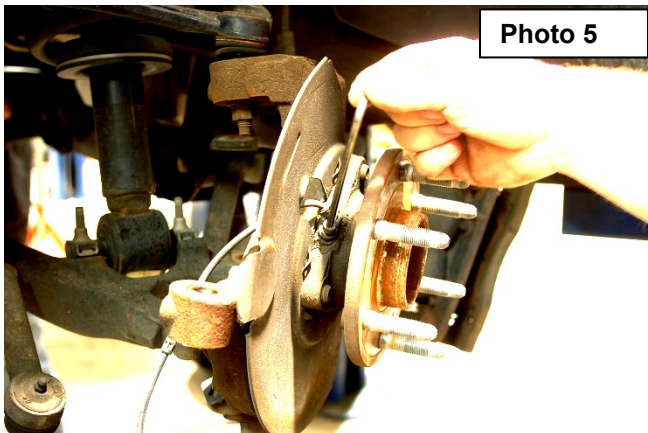

Photo 5

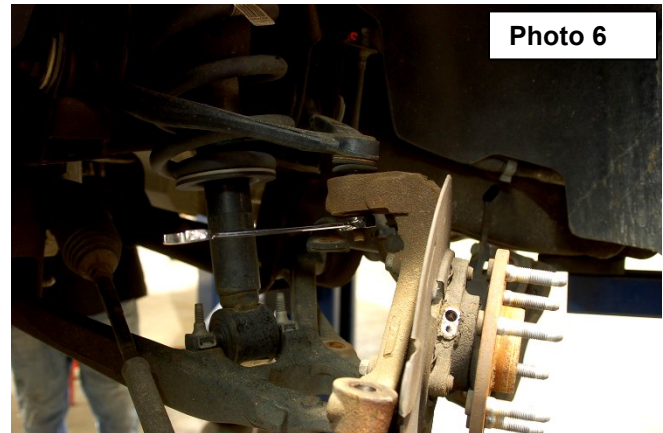

Photo 6

8. Remove the lower ball joint nut using a 24mm wrench, strike the side of the knuckle to dislodge the ball joint. **See Photo 7.** Remove the knuckle from the vehicle.
9. Remove the bearing assemble and dust shield from the stock knuckle using a 15mm socket. **See Photo 8.** Insert bearing assemble and dust shield in the new Rough Country lowering knuckle and tighten.

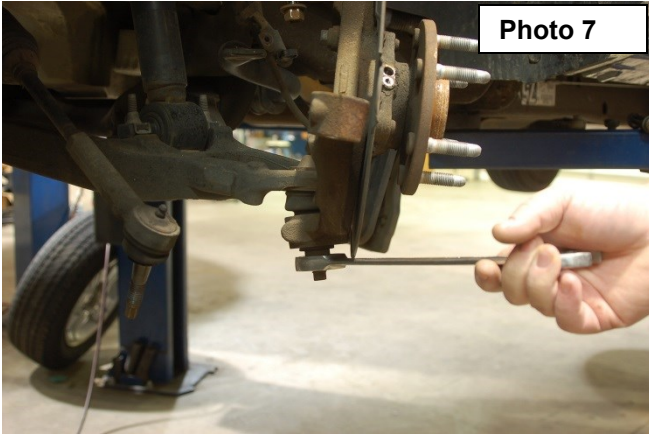

Photo 7

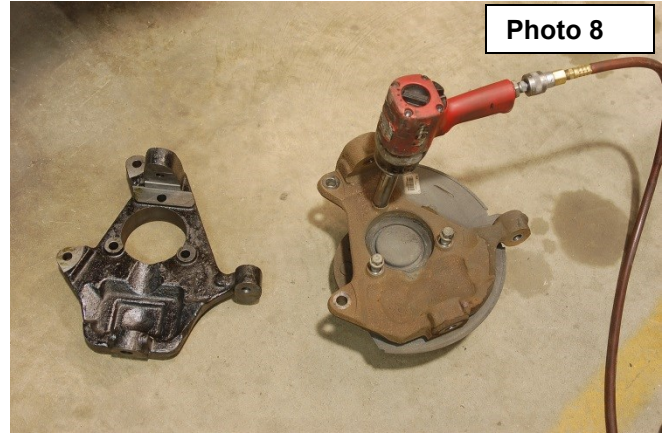

Photo 8

10. Install the knuckle on the lower ball. If using a 20" wheel or bigger use the factory hardware and tighten with a 24mm wrench. **See Photo 9.** Insert the upper ball joint into the knuckle with factory hardware tighten with a 18mm wrench.
11. ****Note**** If you using an 18" wheel with this lowering knuckle you will have to use the supplied 16mm jam nut and internal locking washer. Also the length of the ball stem will have to be cut off. Using a cut off blade cut the threaded stem off 1/8" below the nut. **See Photo 10.**

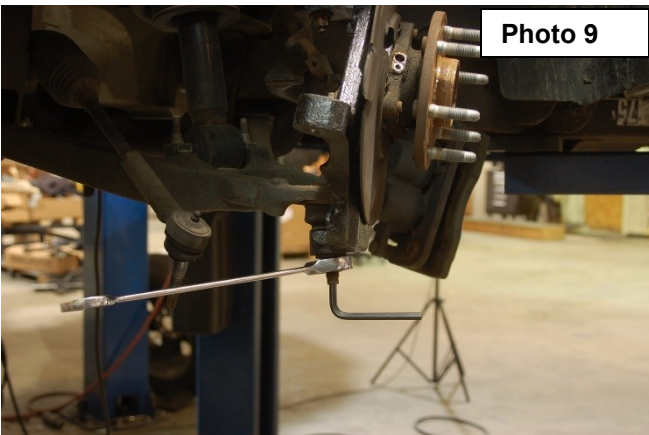

Photo 9

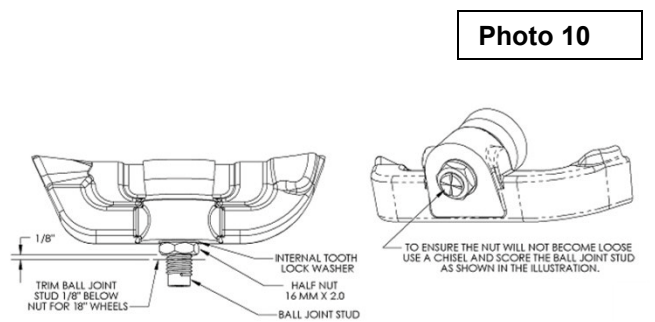

Photo 10

12. Insert the tie-rod end and tighten with a 21mm wrench and install the ABS sensor in the knuckle with a 8mm allen wrench.
13. Install the brake caliper with factory hardware and tighten with a 18mm socket.
14. Place the ABS bracket in a vise and mark a line 1 1/8" from the end of the bracket. Cut the bracket so it fits on top of the new knuckle. **See Photo 11.**
15. Insert the ABS wire back onto the bracket and bolt the bracket to the new knuckle using factory hardware and a 10mm socket. **See Photo 12.** Repeat steps 2-13 on the passenger side.

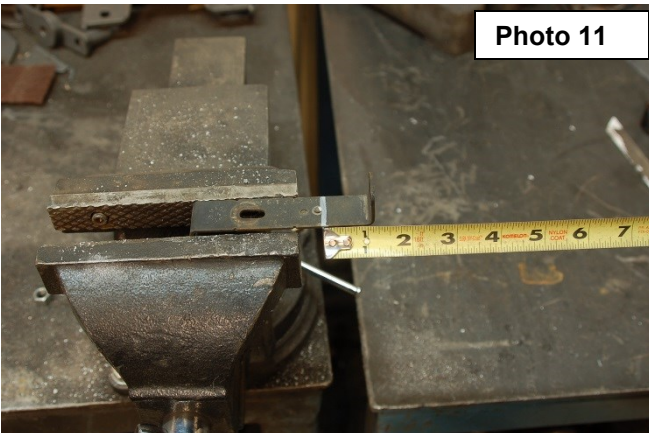

Photo 11

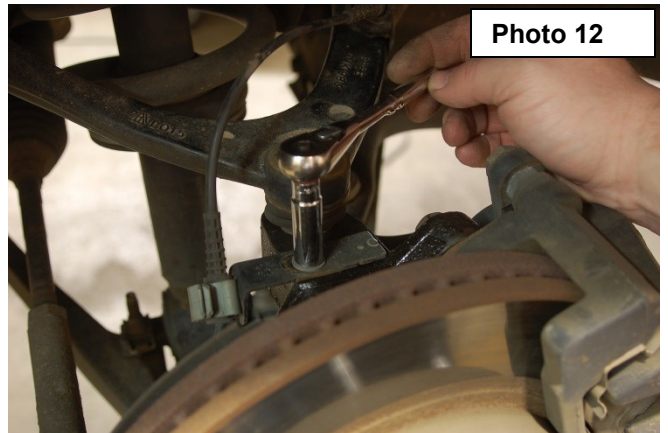

Photo 12

REAR INSTALLATION INSTRUCTIONS

1. Lift the rear of the vehicle using a jack and support the vehicle with jack stands, so that the rear wheels are off the ground.
2. Remove the rear tires/wheels., using a 21mm deep well socket.
3. Remove bump stop. Using a cutoff wheel, cut all 4 sides of the bump stop and remove as shown in **Photo 1**.
4. Using the 2 existing “underneath” welds on frame, measure to center and mark for new bump stop location. **Photo 2**.



5. Drill a 11/32” hole and install the stock bolt along with the factory bump stop.
6. Using a 21mm socket and wrench, remove the shocks. Retain hardware for re-use with new provided RC shock. **Photo 3**.
7. Remove the bolt holding the brake line bracket to the rear-end. **Photo 4**.



8. Supporting rear axle, use a 21mm socket and remove the u-bolts on both driver and passenger side. **Photo 5**.
9. On the passengers side, using a 24mm wrench for nut and a 12mm for bolt on front 21mm for nut and 10mm for bolt on rear, remove the leaf spring bolts and remove from vehicle. **See photo 6** **note* If equipped with tow hitch, this must be removed*

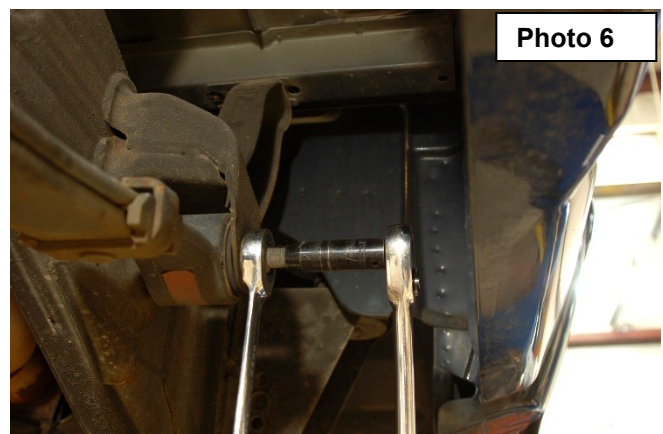
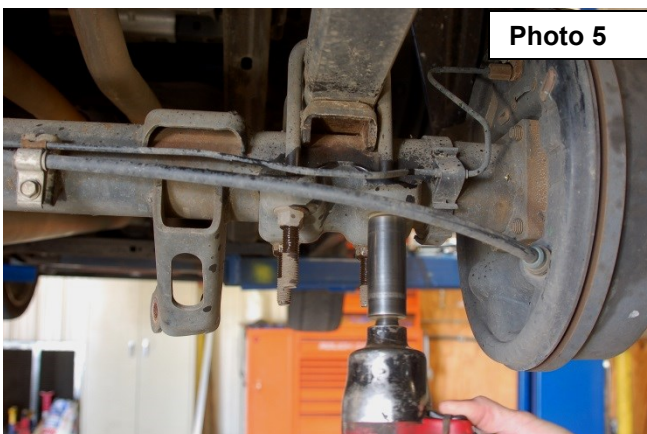

10. Using same wrenches as passenger side leaf, remove the rear bolt in the frame mount and the shackle on the drivers side. Only loosen the front bolt only. Do not remove!
11. Carefully slide the rear end toward the passengers side keeping the axle firmly on the stands for support.
12. Swing the drivers side leaf out and under the axle.
13. As shown in **Photo 7**, using a 15mm wrench and vise grips on the end of the pin, remove the ubolt plate and bolt.
14. After removing plate, flip bolt in insert on the opposite side as shown in **Photo 8**.

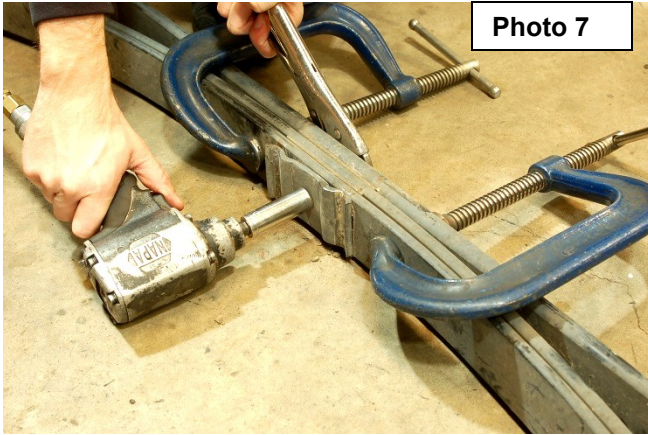

Photo 7

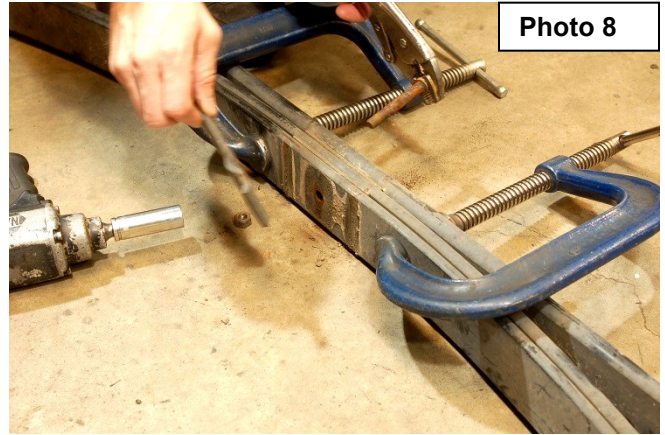

Photo 8

15. Using a 15mm and vise grips, re-tighten pin into the shown position in **Photo 9**.
16. Install Socket Head Bolt and nut into the plate as shown in **Photo 10**. *note direction of plate when placing bolt*

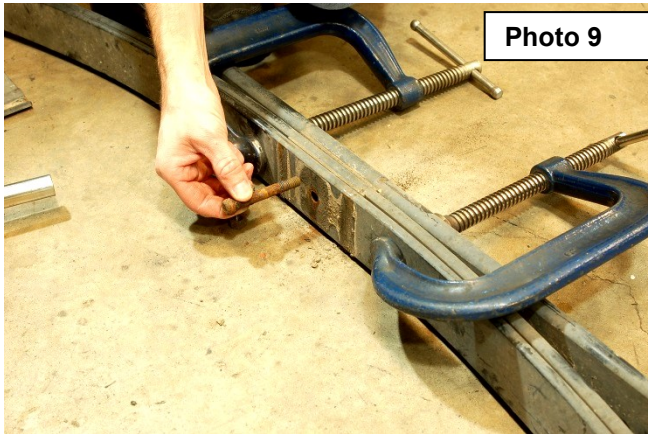

Photo 9



Photo 10

17. Using a 9/16 wrench and 5/16 Allen wrench, tighten bolt in place. **Photo 11**
18. Using 21mm socket and wrench, remove the stock shackle and retain stock hardware. **Photo 12**.

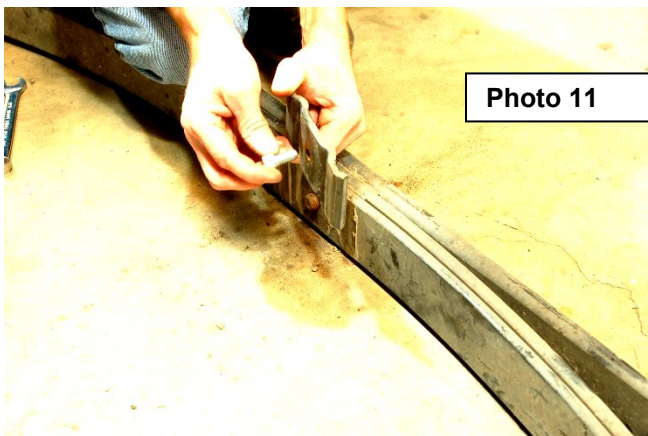

Photo 11



Photo 12

19. Using a die-grinder or air chisel remove the three factory rivets on the hanger bracket. **See Photo 13.**
20. Use a 15mm socket to remove the top rear bolt on the hanger bracket. **See Photo 14.**

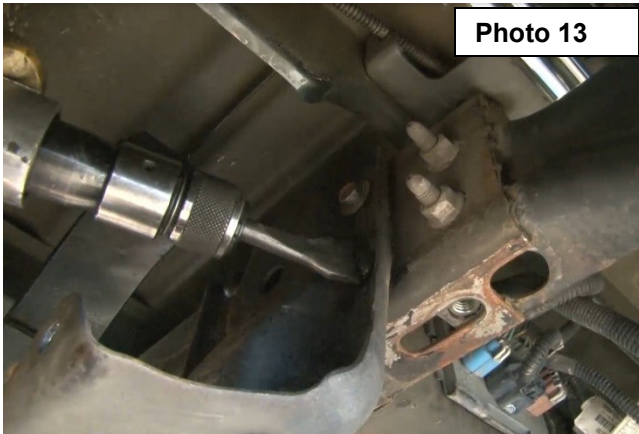

Photo 13



Photo 14

21. Drill out the three rivet holes to 15/32" (clearance for a 7/16" bolt). **See Photo 15.**
NOTE. Some models may need to grind/cut the round frame support flush with frame rail. See Photo 16.

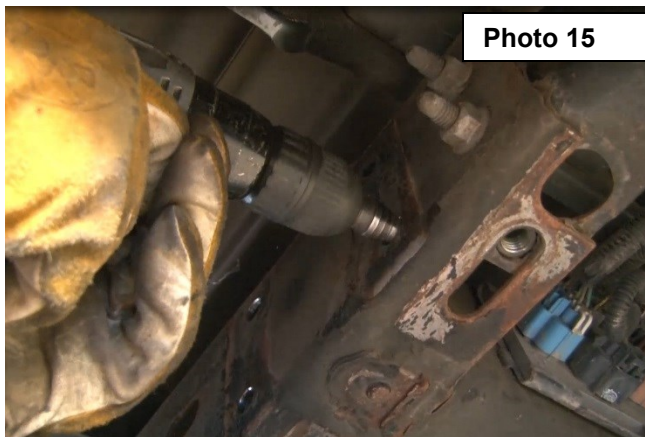

Photo 15



Photo 16

22. Install the new hanger bracket on the frame, insert the factory bolt in the top rear hole and hand tighten. Use the supplied 7/16" x 1 1/4" long bolts, washers, and nuts for the other three holes in the hanger bracket. Tighten 7/16" bolts with a 16mm and 17mm socket and wrench and the stock bolt with a 15mm socket. **See Photo 17.**
23. Reinstall the driver leaf spring using the stock bolts with axle on top side of leaf. You will need the 24mm wrench with the 12mm on end and the 21mm wrench with 10 mm on end. Tighten to correct torque spec.
24. Install the factory shackle in the lower hole of the hanger bracket, using the stock hardware and previous wrenches used. **See Photo 18.** The lower hole is a 4" drop in the rear and the upper hole of the hanger bracket is a 4.5" drop.

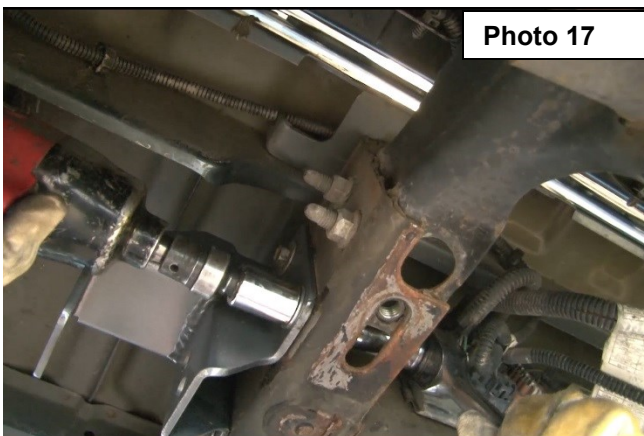

Photo 17



Photo 18

25. On the drivers side frame, remove the e brake cable hanger using a 13mm socket.
26. Install the provided axle saddle with the spring hole positioned to the front of the truck. **See Photo 19.**
27. Place the supplied u-bolts over the axle tube as shown in **Photo 20.**

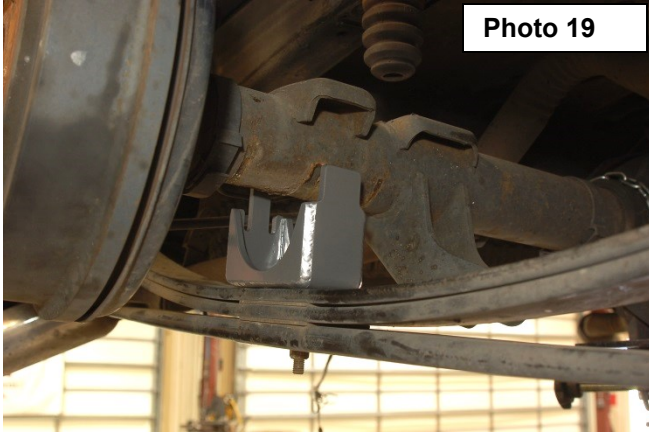

Photo 19

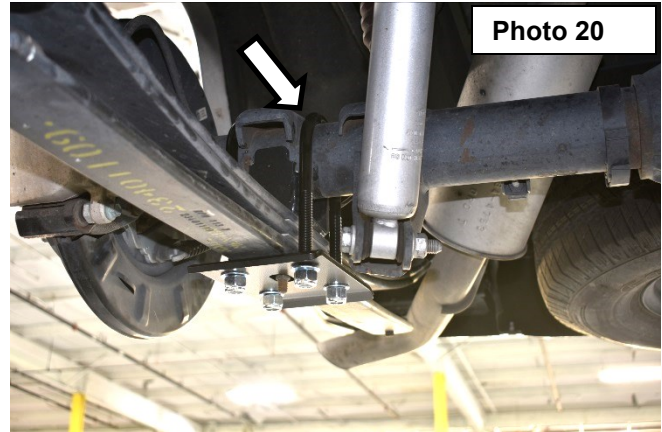

Photo 20

28. Install the provided bottom plate and supplied u-bolt hardware as shown in **Photo 21.**
29. Using a 22 mm socket, tighten the u-bolt nuts. Torque to 90ft-lbs using an X pattern. **See Photo 22.**

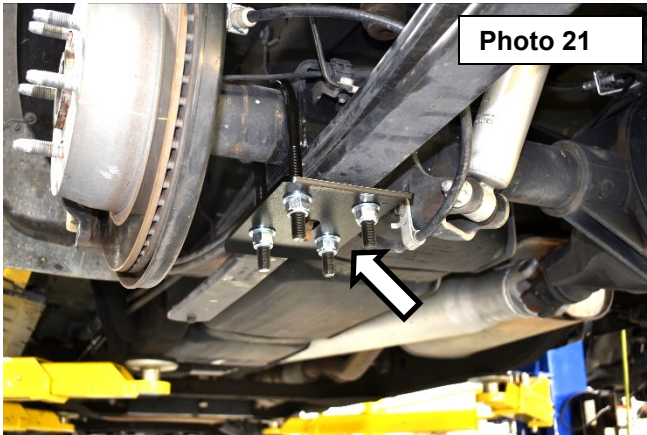

Photo 21

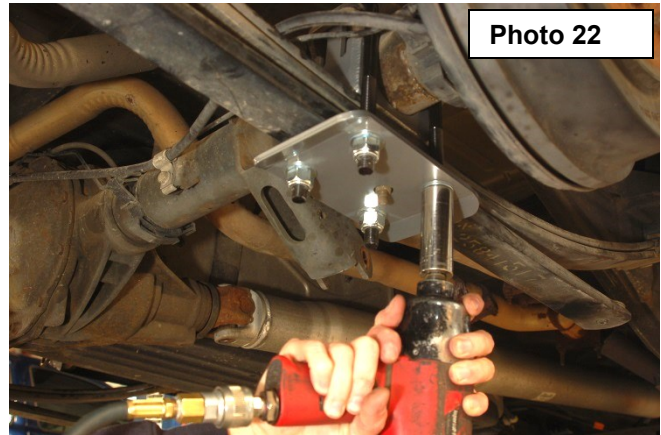

Photo 22

30. Repeat steps 3-25 for passenger side.
31. Reinstall the brake line bracket to the axle using a 13mm wrench.
32. Reinstall the bolt in the e-brake hanger on the drivers side frame using a 13mm wrench.
33. Install the supplied shocks, using existing hardware, with a 21mm wrench and a 21mm socket. **See Photo 23 & 24.**



Photo 23

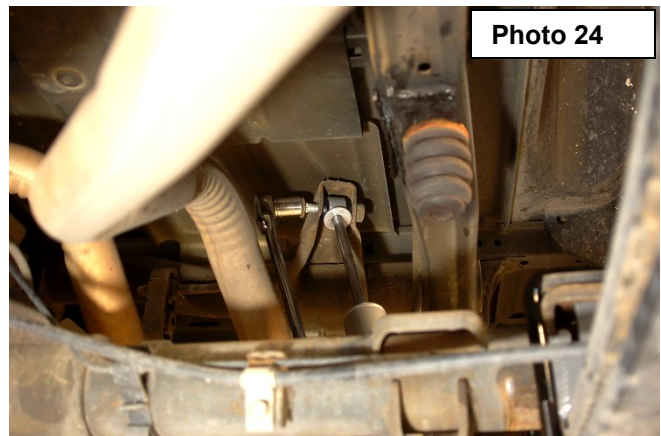

Photo 24

34. If truck was equipped , reinstall the factory hitch.
35. Install the rear tires/wheels., using a 21mm deep well socket.
36. Remove all jack stands.
37. Lower vehicle and follow post installation instructions below.

POST INSTALLATION

1. Check all fasteners for proper torque. Check to ensure there is adequate clearance between all rotating, mobile, fixed and heated members. Check steering for interference and proper working order. Test brake system.
2. Perform steering sweep. The distance between the tire sidewall and the brake hose must be checked closely. Cycle the steering from full turn to full turn to check for clearance.
3. Re torque all fasteners after 500 miles. Visually inspect components and re torque fasteners during routine vehicle service.
4. Readjust headlights to proper settings and take truck in for a front-end alignment to a qualified alignment professional.



Kit Contents

71630BOX1

- 1 - Dr Side Lowering Knuckle
- 1 - Pass Side Lowering Knuckle

71630BOX2

- 1 - 1721BAG1
 - 2 - 3/8"-16x3/4" SHC Bolts
 - 2 - 3/8"-16 Lock Nuts
 - 7 - 7/16"-14x1.25 Bolts
 - 7 - 7/16"-14 Lock Nuts
 - 14 - 7/16" Flat Washers
- 1 - 71630BAG
 - Instruction Sheet
- 1 - 71830BAG1
 - 8 - Ctrl Arm Cam Adj Plates
- 1 - 9/16BAG
 - 8 - 9/16"-18 Lock Nuts
 - 8 - 9/16" Flat Washers
- 4 - U-bolts
- 2 - U-bolt Plates
- 1 - Instruction Sheet
- 2 - Lowering Axle Flip
- 2 - Adj Hanger Relocation Brackets
- 2 - N3 Shocks

SIZE	 SAE GRADE 5		 SAE GRADE 8		 L9
	ASSEMBLY TORQUE DRY	LUBRICATED	ASSEMBLY TORQUE DRY	LUBRICATED	ASSEMBLY TORQUE LUBRICATED
1/4-20	8	75*	12	9	11
1/4-28	10	86*	14	10	13
5/16-18	17	13	20	18	21
5/16-24	19	14	25	20	23
3/8-16	30	23	45	30	33
3/8-24	35	25	50	35	38
7/16-14	50	35	70	55	60
7/16-20	55	40	80	60	65
1/2-13	75	55	110	80	95
1/2-20	90	65	120	90	105
9/16-12	110	80	150	110	140
9/16-18	120	90	170	130	150
5/8-11	150	110	220	170	185
5/8-18	180	130	240	180	205
3/4-10	260	200	380	280	290
3/4-16	300	220	420	320	355

BOLT TORQUE CHART

ITEMS WITH * = INCH POUNDS
ALL OTHERS = FOOT POUNDS

By purchasing any item sold by Rough Country, LLC, the buyer expressly warrants that he/she is in compliance with all applicable, State, and Local laws and regulations regarding the purchase, ownership, and use of the item. It shall be the buyers responsibility to comply with all Federal, State and Local laws governing the sales of any items listed, illustrated or sold. The buyer expressly agrees to indemnify and hold harmless Rough Country, LLC for all claims resulting directly or indirectly from the purchase, ownership, or use of the items.

