

ROUGH COUNTRY

SUSPENSION SYSTEMS®



57730INSTBAG

FORD 2021 F-150 3" Suspension Kit

Thank you for choosing Rough Country for all your suspension needs.

Rough Country recommends a certified technician install this system. In addition to these instructions, professional knowledge of disassembly/reassembly procedures as well as post installation checks must be known. Attempts to install this system without this knowledge and expertise may jeopardize the integrity and/or operating safety of the vehicle.

▲ NOTICE Please read instructions before beginning installation. Check the kit hardware against the parts list on the next page. Be sure you have all needed parts and know where they go. Also, please review tools needed list and make sure you have the needed tools.

PRODUCT USE INFORMATION

▲ WARNING As a general rule, the taller a vehicle is, the easier it will roll. Seat belts and shoulder harnesses should be worn at all times. Avoid situations where a side rollover may occur. Generally, braking performance and capability are decreased when larger/heavier tires and wheels are used. Take this into consideration while driving. Do not add, alter, or fabricate any factory or after-market parts to increase vehicle height over the intended height of the Rough Country product purchased. Mixing component brands is not recommended. Rough Country makes no claims regarding lifting devices and excludes any and all implied claims. We will not be responsible for any product that is altered. If questions exist we will be happy to answer any questions concerning the design, function, and correct use of our products.

This suspension system was developed using a 34" or 295/70R18-295/60R20, tire on 9" wheels with a +12 offset. Factory wheels and tires can be used. If using a larger tire on the factory wheel, wheel spacers are required. **Note** if wider tires are used, offset wheels will be required and trimming will be required.

▲ WARNING This vehicle will require the EPAS (Electronic Power Assist Steering) plugs to be disconnected prior to beginning installation of this kit. See installation instructions. Failure to disconnect these plugs may result in damage to the EPAS module resulting in an error message being displayed, which will require replacement of the EPAS module.

DEALER AND VEHICLE OWNER

▲ NOTICE Any vehicle equipped with any Rough Country product should have a "Warning to Driver" decal installed on the inside of the windshield or on the vehicle's dash. The decal should act as a constant reminder for whoever is operating the vehicle of its unique handling characteristics.

INSTALLING DEALER - it is your responsibility to install the warning decal and forward these installation instructions on to the vehicle owner for review. These instructions should be kept in the vehicle for its service life.

▲ NOTICE Note to installer : Before installation begins we recommend that a test drive be performed. While driving check for uncommon sounds and/or vibrations . What you feel and hear during the test drive will only magnify once lift kit is installed. Advise you to discuss possible issues identified from drive with customer before proceeding to install this kit.



Kit Contents: 57730

57730INSTBAG x1
54531BAG2 x1
569BAG1 x1
N3 Rear Shock (660771) x2
2.5" Rear Block x2
Dr. Upper Control Arm x1
Pass. Upper Control Arm x1
9/16 Bag x1
U-bolts x4
10mm Studbag-2 x1
Strut Spacer Side (A) x1
Strut Spacer Side (B) x1
Preload Spacer x2
RCK6696P2BAG x2

57730INSTBAG:

Instruction Sheet
Vertex Instructions Sheet

54531BAG2: For Upper Ball Joints.

1/2" Flat Washer x2

9/16 Bag: For U-bolts.

9/16 Flat Washers x8
9/16-18 Nylock Nut x8

10mm STUDBAG-2: For upper strut spacers.

1/2-20 Jam Nut x1
10mm-1.25 Hex Nut x1
10mm-1.25 Strut Spacer Stud x6
10mm-1.25 Serrated Flange Nut x6

RCK6696P2BAG

Ball Joint Hardware Bag

Kit Contents: 57731

57730INSTBAG x1
54531BAG2 x1
3" N3 Loaded Strut x2
N3 Rear Shock (660771) x2
2.5" Rear Block x2
Dr. Upper Control Arm x1
Pass. Upper Control Arm x1
9/16 Bag x1
U-bolts x4
RCK6696P2BAG x2

57730INSTBAG:

Instruction Sheet
Vertex Instructions Sheet

54531BAG2: For Upper Ball Joints.

1/2" Flat Washer x2

9/16 Bag: For U-bolts.

9/16 Flat Washers x8
9/16-18 Nylock Nut x8

RCK6696P2BAG

Ball Joint Hardware Bag

Kit Contents: 57750

57730INSTBAG x1
54531BAG2 x1
Dr. Vertex 3" Coilover x1
Pass. Vertex 3" Coilover x1
Rear Vertex 2" Shock x2
2.5" Rear Block x2
Dr. Upper Control Arm x1
Pass. Upper Control Arm x1
9/16 Bag x1
U-bolts x4
RCK6696P2BAG x2

57730INSTBAG:

Instruction Sheet
Vertex Instructions Sheet

54531BAG2: For Upper Ball Joints.

1/2" Flat Washer x2

9/16 Bag: For U-bolts.

9/16 Flat Washers x8
9/16-18 Nylock Nut x8

RCK6696P2BAG

Ball Joint Hardware Bag

Kit Contents: 57757

57730INSTBAG x1
54531BAG2 x1
Dr. Vertex 3" Coilover x1
Pass. Vertex 3" Coilover x1
Rear V2 Monotube Shock x2
2.5" Rear Block x2
Dr. Upper Control Arm x1
Pass. Upper Control Arm x1
9/16 Bag x1
U-bolts x4
RCK6696P2BAG x2

57730INSTBAG:

Instruction Sheet
Vertex Instructions Sheet

54531BAG2: For Upper Ball Joints.

1/2" Flat Washer x2

9/16 Bag: For U-bolts.

9/16 Flat Washers x8
9/16-18 Nylock Nut x8

RCK6696P2BAG

Ball Joint Hardware Bag



Kit Contents: 57770

- 57730INSTBAG x1**
- 54531BAG2 x1**
- 3" N3 Loaded Strut x2**
- Rear V2 Monotube Shock x2**
- 2.5" Rear Block x2**
- Dr. Upper Control Arm x1**
- Pass. Upper Control Arm x1**
- 9/16 Bag x1**
- U-bolts x4**
- RCK6696P2BAG x2**

Tools Needed

- 15mm Wrench
- 15mm Socket
- 29mm Socket
- 1 1/16" Wrench
- 21mm Wrench
- 16 mm Wrench
- 3/8" mm Wrench
- 9/16" Wrench
- 9/16" Socket
- Hammer
- Floor Jack
- Jack Stands
- 18mm Socket

57730INSTBAG:

- Instruction Sheet
- Vertex Instructions Sheet

54531BAG2: For Upper Ball Joints.

- 1/2" Flat Washer x2

9/16 Bag: For U-bolts.

- 9/16 Flat Washers x8
- 9/16-18 Nylock Nut x8

RCK6696P2BAG

- Ball Joint Hardware Bag

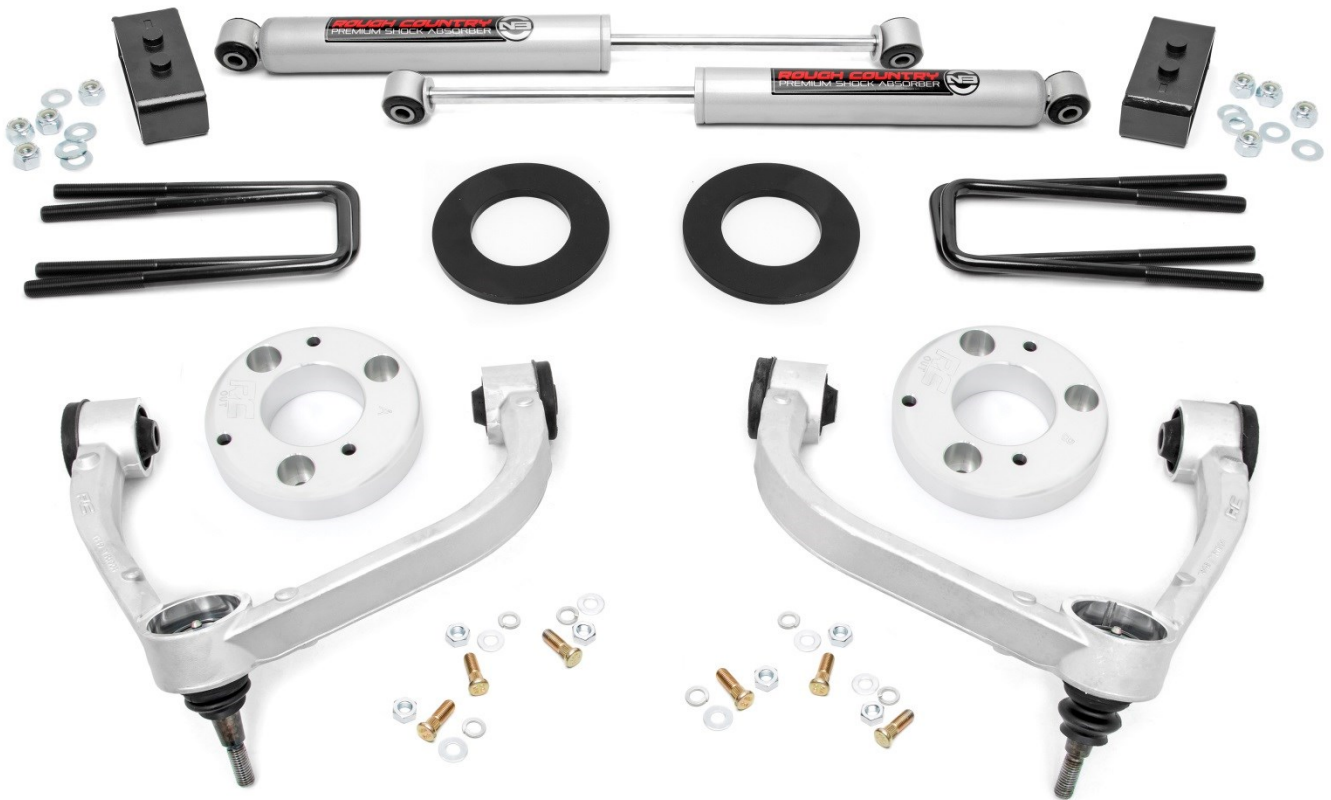

Torque Specs:

Size	Grade 5	Grade 8	Size	Class 8.8	Class 10.9
5/16"	15 ft/lbs	20ft/lbs	6MM	5ft/lbs	9ft/lbs
3/8"	30 ft/lbs	35ft/lbs	8MM	18ft/lbs	23ft/lbs
7/16"	45 ft/lbs	60ft/lbs	10MM	32ft/lbs	45ft/lbs
1/2"	65 ft/lbs	90ft/lbs	12MM	55ft/lbs	75ft/lbs
9/16"	95 ft/lbs	130ft/lbs	14MM	85ft/lbs	120ft/lbs
5/8"	135ft/lbs	175ft/lbs	16MM	130ft/lbs	165ft/lbs
3/4"	185ft/lbs	280ft/lbs	18MM	170ft/lbs	240ft/lbs



INSTALLATION INSTRUCTIONS

1. Jack up the front of the vehicle and support the vehicle with jack stands, so that the front wheels are off the ground. Next, remove the front tires/wheels, using a 21mm deep well socket.
2. Using a 15mm socket remove the front skid, if the truck is equipped with a full front skid.
3. Disconnect the EPAS (Electronic Power Assist Steering) Plugs as shown located on the steering assembly by the front differential. **See Photo 1 & 2. This must be done BEFORE installation is started.**
4. Using a 21mm wrench remove the nut from the tie rod on the knuckle. Using a tie rod/ball joint puller, remove the

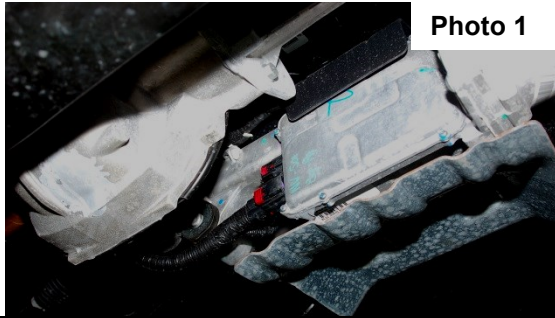

Photo 1

Locate the EPAS plug.

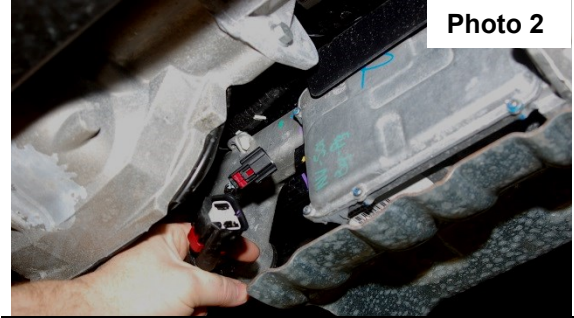

Photo 2

Unplug the EPAS.

tie rod from the knuckle. Push linkage forward to make room for installation. Retain factory hardware. **See Photo 3.**

5. Using a 8mm socket remove the ABS bracket from the knuckle and also remove the brake line bracket with a 10mm socket. **See Photo 4.**
6. Next remove the caliper bolts with a 18mm socket as shown in **Photo 5** and the dust shield bolts with a 8mm

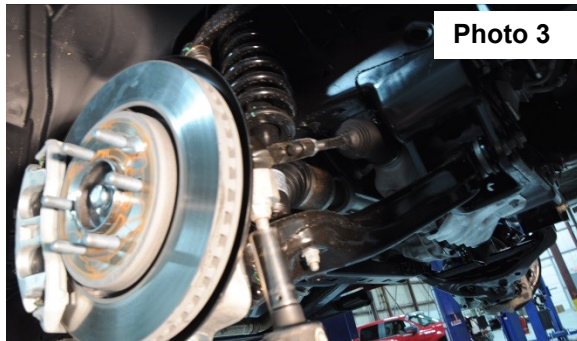

Photo 3

Remove the tie rod end from the knuckle.

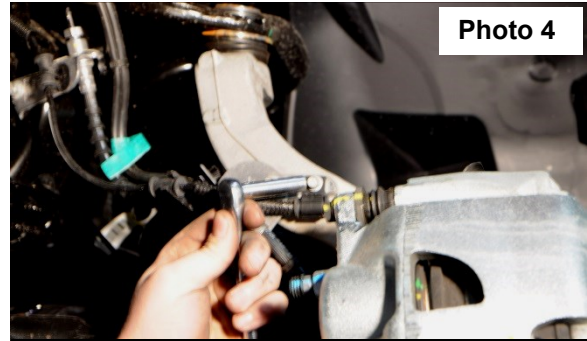

Photo 4

Remove the ABS bracket from the knuckle.

socket. Remove the ABS wire from the knuckle with a 5mm Allen wrench.

7. Use a pair of pliers to pull off the axle dust cap and remove the axle nut with a 15mm socket. **See Photo 6.**
8. Remove the sway bar nut using a 18mm wrench. Retain factory hardware.

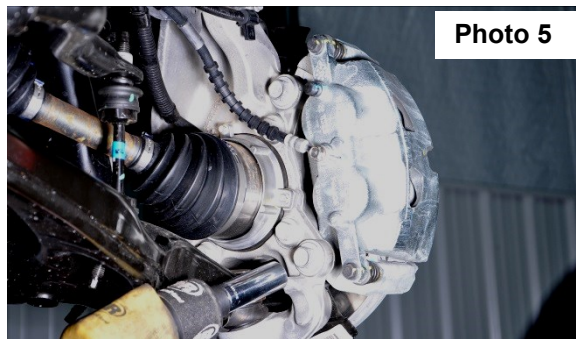

Photo 5

Remove the brake caliper.

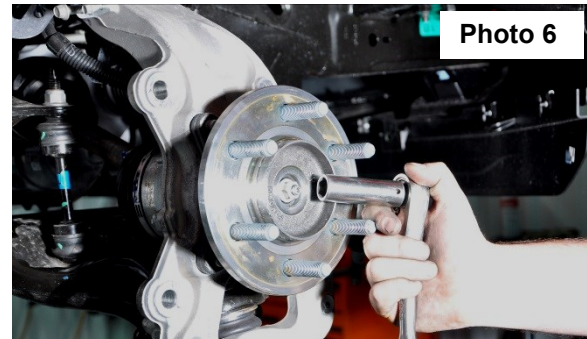

Photo 6

Remove the axle nut.

9. Using a 21mm wrench and a 1 1/16" socket loosen the lower control arm bolts. Do not remove the bolts just loosen them so you can later swing the lower control arm down.
10. Place jack stand under the lower control arm for support. Loosen the upper ball joint nut using a 18mm wrench.

Unseat the upper ball joint taper from the knuckle using a hammer, striking the knuckle. Then remove the upper ball joint nut and remove the upper ball joint from the knuckle.

11. Do not allow the knuckle to pull out far enough that it pulls the shaft out of the differential. **See Photo 7.**
12. Remove the lower strut bolt using a 30mm socket and 27mm wrench for 09-13 models and 18mm socket for 14-20 models. **See Photos 8a&b.** Retain hardware for reuse.

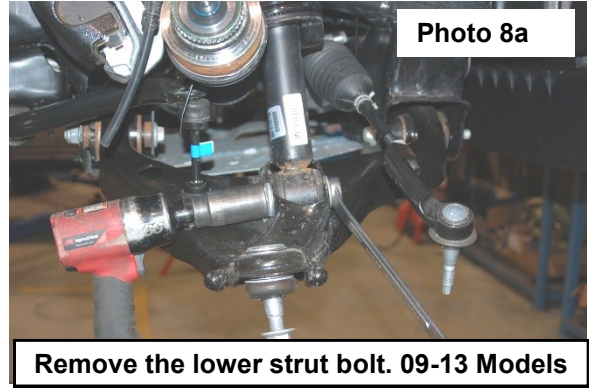
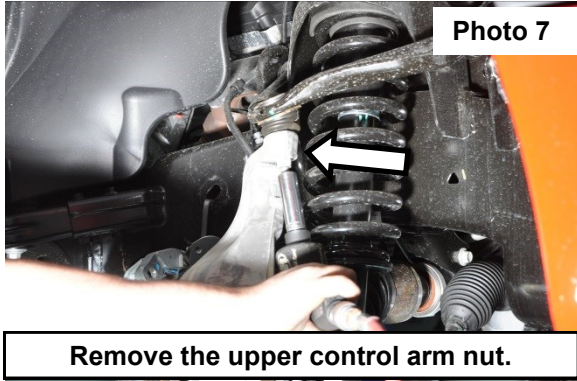

13. Using a 18mm wrench, remove the nuts on the upper strut tower that holds the assembly in place. **See Photo 9.**
14. Lower the jack to let the lower control arm and knuckle swing down so the strut can be removed.

▲ NOTICE We recommend using OE instructions for disassembly and assembly of IWE actuator, the following instructions are for reference only.

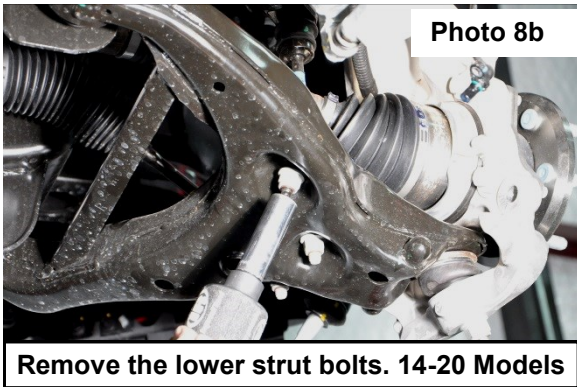

15. Disconnect vacuum tubes from the actuator. **See Photo 10.**
16. Using a 8mm wrench, remove the (3) bolts securing the actuator to the knuckle. **See Photo 11.**
17. Push CV axle inward allowing the knuckle to pivot outward to allow for more clearance to remove the strut.

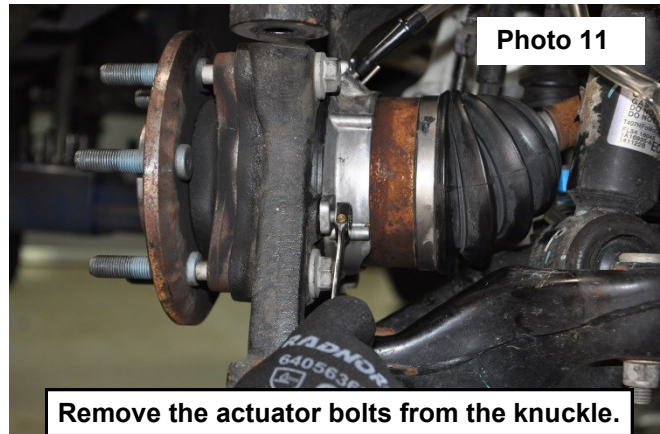
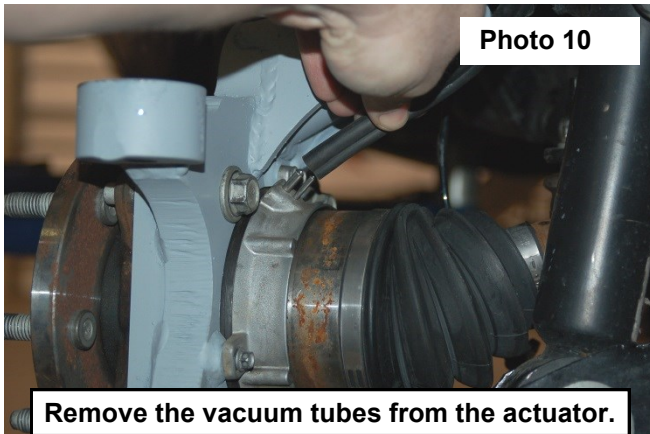

NOTE: If installing N3 Loaded Struts, V2 Monotube Shocks, or Vertex Coilovers, refer to the instructions provided with those kits and skip to step 27.

18. Make an alignment mark on the strut through the top hat, coil spring and the strut. **See Photo 12.**
19. Compress the strut in the strut compressor. Then use a 15mm socket to remove the nut from the top of the strut, remove the strut. **See Photo 13.**

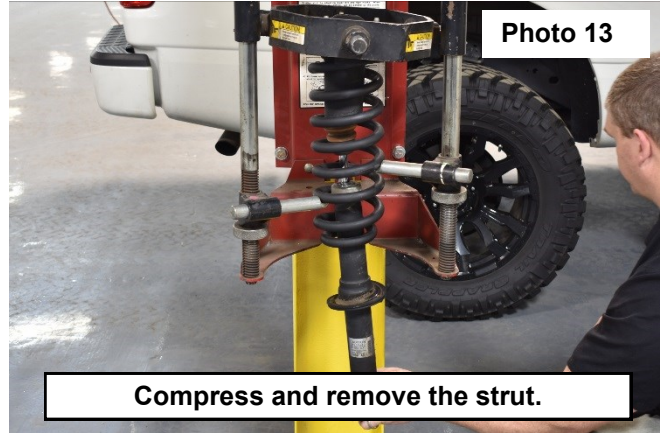
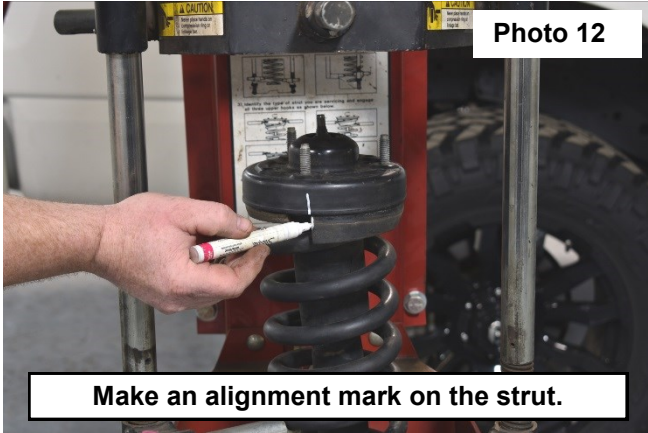

20. Remove the top hat from the rubber isolator leaving the rubber isolator on the coil spring. **See Photo 14.**
21. Place the preload spacer onto the isolator and install the top hat. Line up the marks made on each part. **See Photo 15.**



22. Install the strut lining the marks up and tighten using a 15mm socket. **See Photo 16.**
23. Insert the stud through the back side of the spacer. Use the supplied washers and nut to pull the stud into place. **See Photo 17.**

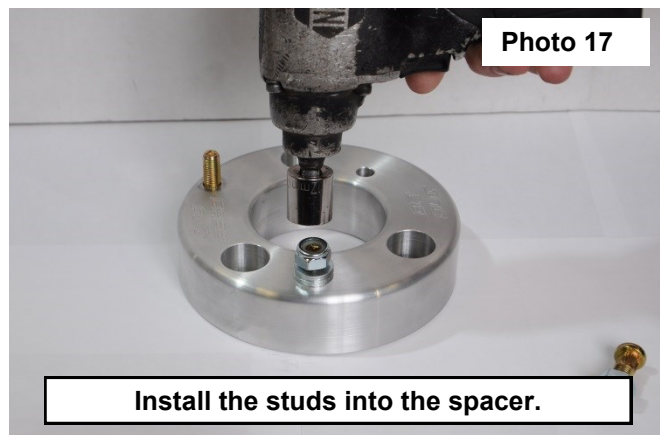

24. For 2021 Looking at the strut spacer make sure you have two (A) spacers as shown below in the CAD drawing. When installing the spacers both sides will have the RC logo to the outside.

2021 F-150 Strut Spacers
Insert studs into both A spacers

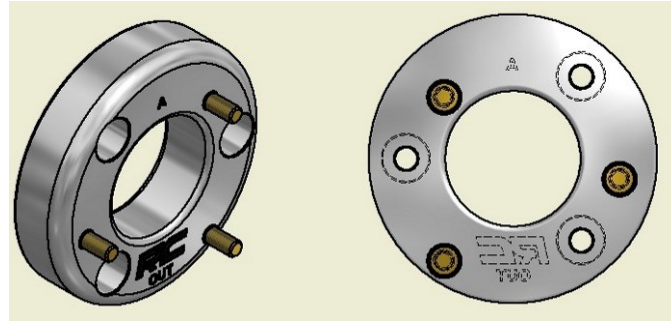

25. Install the new strut spacer on the strut, 2009-14 will use stock hardware and 9/16" socket and 2015-20 will use supplied 10mm nuts and 17mm socket from 569bag1. Torque to 30 ft/lbs. **See Photo 18.**
26. Remove the upper control arm using a 21mm and 22mm wrench. Retain hardware for reuse. **See Photo 19.**

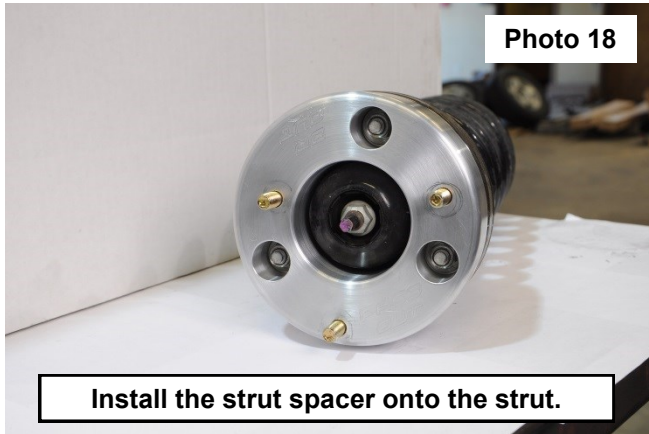

Photo 18

Install the strut spacer onto the strut.

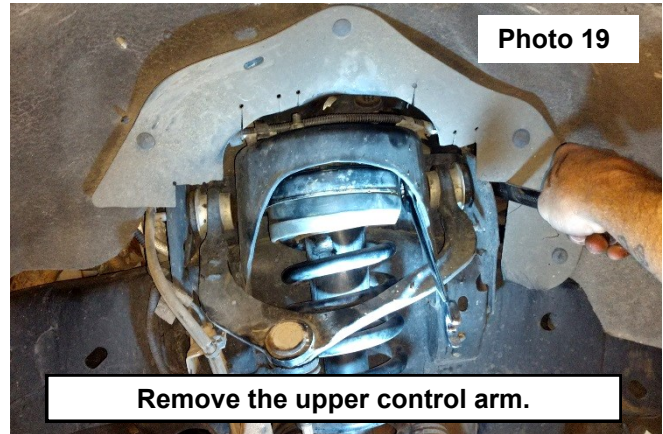

Photo 19

Remove the upper control arm.

27. Install the new upper control arm using the retained hardware. Do not tighten at this time. **See Photo 20.**
28. Install the strut into upper mount using the 10mm nut, lock washer and flat washer from 569bag1. **See Photo 21.**

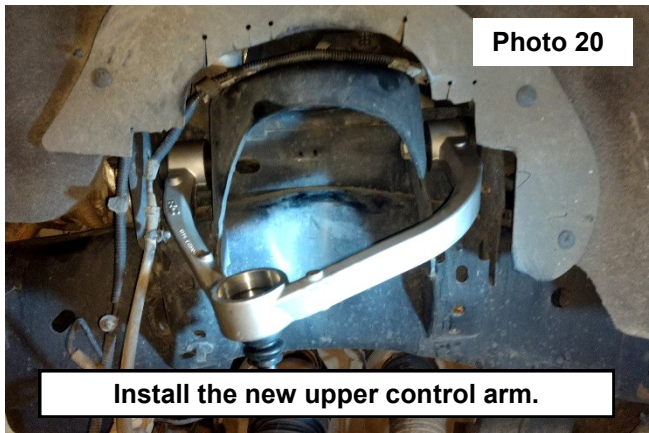

Photo 20

Install the new upper control arm.

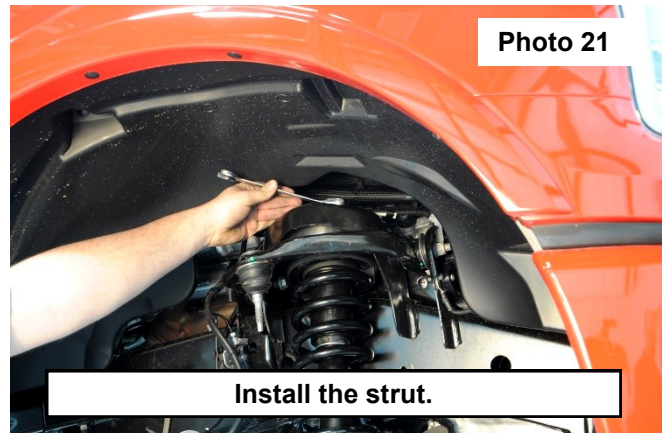
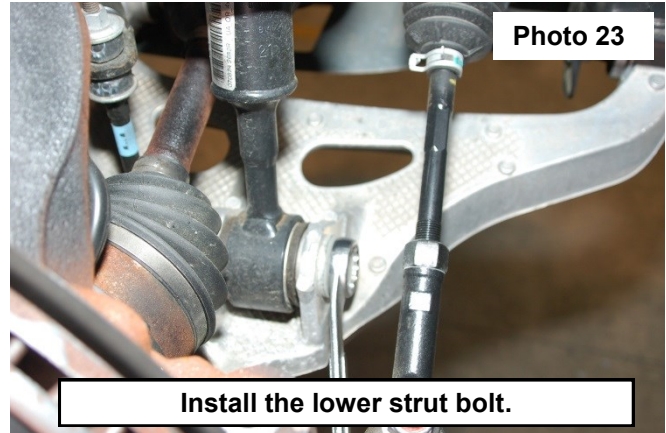
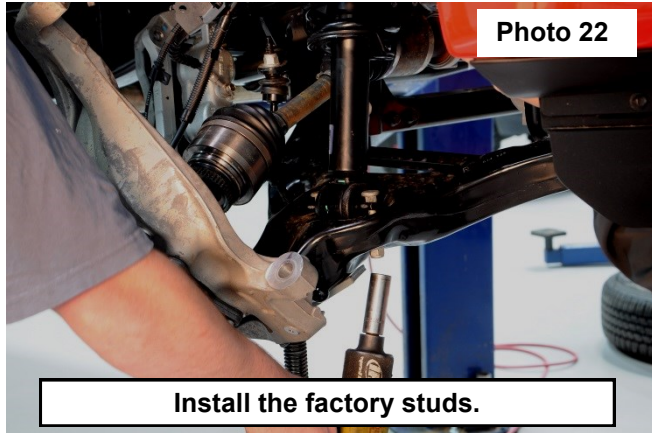

Photo 21

Install the strut.

29. **2014-20 Models.** Spin and align the lower mount of the strut with the lower control arm mount. Install the factory studs back into the barpin on the lower mount of the strut. It may be necessary to hit the top of the strut with a hammer to seat the splines before tightening the factory nuts with a 18mm. **See Photo 22.**
30. **2004-13 models** install the lower strut bolt in the original position that it was removed. Using a 29mm socket, and 1 1/16" wrench, torque to factory specs. **See Photo 23.**



31. **▲ NOTICE** Make sure the actuator splines line up to the splines on the CV shaft. See photo 24.
32. Install CV shaft into the knuckle assembly. See Photo 25.

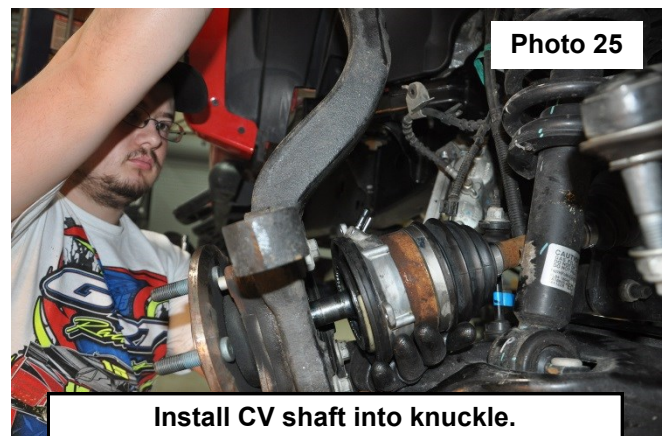
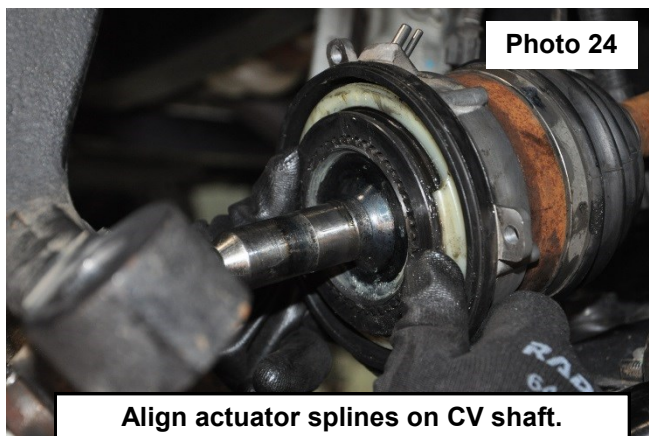

33. Using a floor jack, raise the lower control arm and connect the upper ball joint on the upper control arm to the spindle. Use the supplied 1/2" washer from 54531BAG2, place between knuckle and nut. See Photo 26. Ball joint must be greased before use and checked every 3000 miles.



34. Reinstall the steering linkage nut using a 21mm wrench. Using a hand vacuum pump, apply and hold 24inHG of vacuum to the actuator through the large port. **See Photos 27 and 28.**

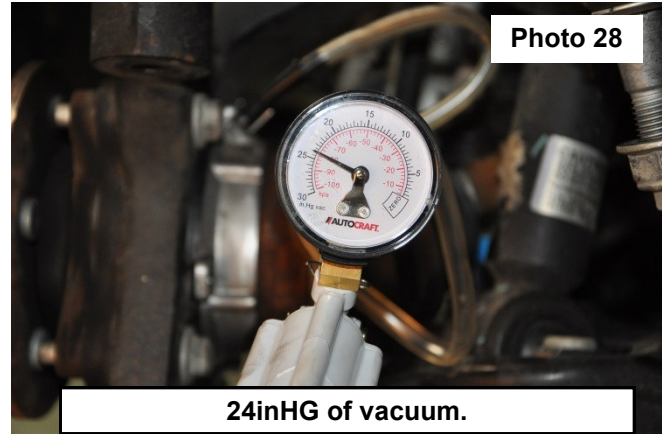
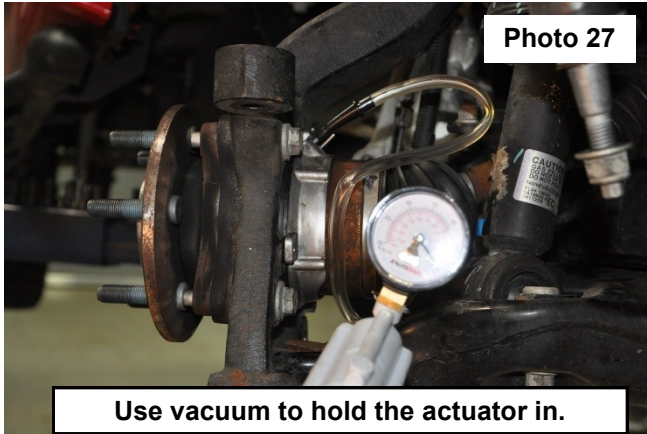

35. Install the (3) bolts securing the actuator to the knuckle and tighten using an 8mm wrench. **See Photo 29.**
36. With vacuum still applied to actuator. Measure the depth of the CV shaft threads protruding through the hub bearing. If **minimum 15.5mm or .61"** is not achieved, rotate the hub to eliminate binding of the splines. **See Photo 30.**

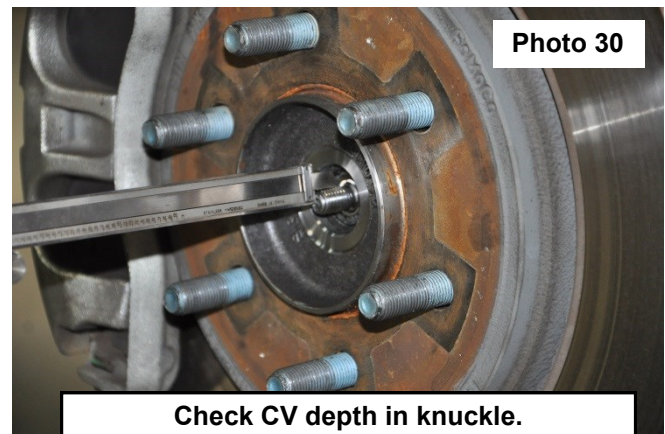
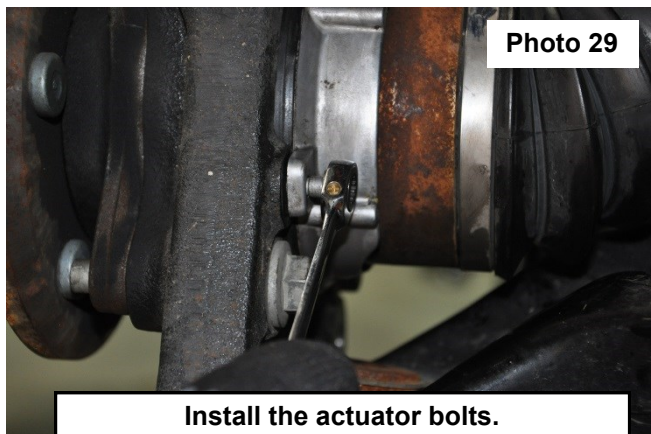

37. Install axle nut and tighten to 30 ft/lbs. **▲ NOTICE Do Not Use an impact**, caution must be taken or damage to shaft may occur.
38. Verify free rotation of the hub with **NO** CV shaft rotation. No clicking or grinding noise should be present
39. Release the vacuum from the actuator and rotate the hub to engage the actuator. You may hear/feel the actuator engage.
40. Verify that the hub and CV rotate together. Reconnect the vacuum lines to the actuator.
41. Next slide on the brake rotor and install the brake caliper with the factory hardware and a 18mm socket.
42. Install the ABS line to the knuckle.
43. Repeat steps 4-43 on opposite side of vehicle.
44. Using a 18mm wrench, reinstall sway bar using factory hardware. Torque to factory specs.
45. Install the wheels / tires, using a 21mm deep well socket.
46. Reconnect the EPAS plugs.
47. Jack up the vehicle and remove the jack stands. Lower the vehicle to the floor and torque all bolts to factory specifications.
48. Tighten the upper control arms using a 21mm and 22mm socket.
49. Vehicle will have to have a front-end alignment.
50. If the rear block kit & shocks were ordered with the kit please proceed to the next section.

REAR INSTALLATION INSTRUCTIONS

1. Chock the front wheels.
2. Jack up the rear of the vehicle and place jack stands underneath the frame rail.
3. Remove the tires and wheels.
4. Remove rear shocks using a 15mm, and 18mm wrench. Save the stock hardware it will be used later.
5. Place the floor jack underneath the axle and remove the stock u-bolts and blocks by lowering the axle. Install the new blocks between the spring and the axle perch. Install the new u-bolts and secure with fasteners provided.
6. Install the supplied rear shocks in the stock position with stock hardware, using a 15mm and 18mm wrench.
Note: N3 shock absorbers are designed to run with the body of the shock absorber on the axle mount and the piston rod on the frame end.

⚠ WARNING For 2015-21 Do not cut or remove factory crash bar if equipped.

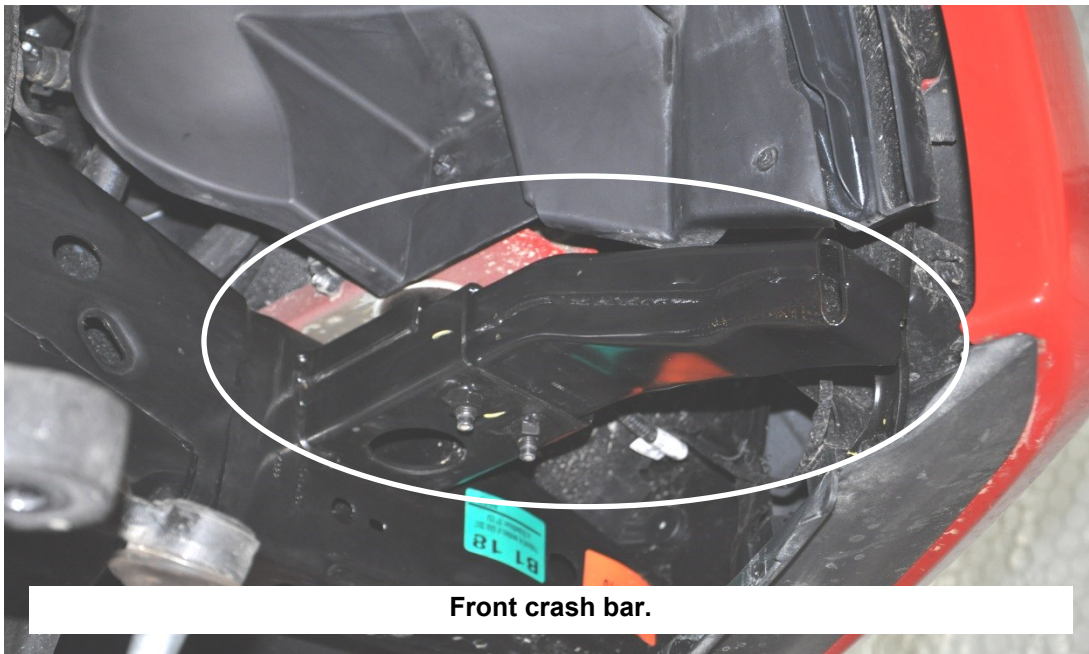

Front crash bar.

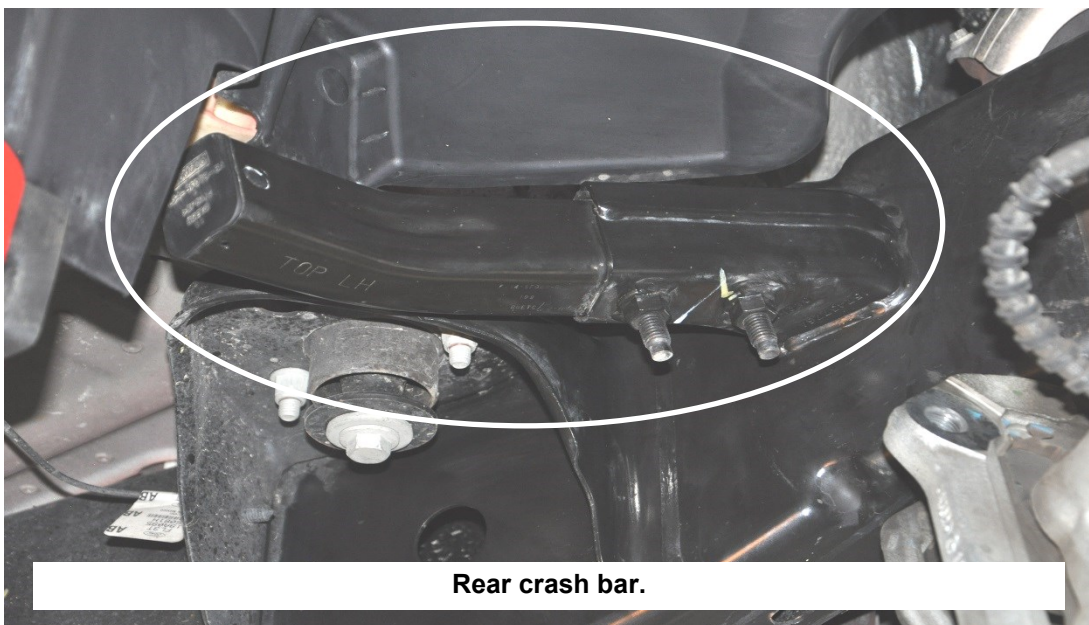

Rear crash bar.

POST INSTALLATION INSTRUCTIONS

1. Check all fasteners for proper torque. Check to ensure there is adequate clearance between all rotating, mobile, fixed and heated components. Check steering for interference and proper working order. Test brake system.
2. Perform steering sweep. The distance between the tire sidewall and the brake hose must be checked closely. Cycle the steering from full turn to full turn to check for clearance. Failure to perform inspections may result in component failure.
3. Re-torque all fasteners after 500 miles. Visually inspect components and re torque fasteners during routine vehicle service.
4. Readjust headlights to proper settings.

MAINTENANCE INFORMATION

It is the ultimate buyers responsibility to have all bolts/nuts checked for tightness after the first 500 miles and then every 1000 miles. Wheel alignment steering system, suspension and driveline systems must be inspected by a qualified professional mechanic at least every 3000 miles

Upper control arm orientation.



Thank you for purchasing a Rough Country Suspension System.

By purchasing any item sold by Rough Country, LLC, the buyer expressly warrants that he/she is in compliance with all applicable Federal, State, and Local laws and regulations regarding the purchase, ownership, and use of the item. It shall be the buyers responsibility to comply with all Federal, State and Local laws governing the sales of any items listed, illustrated or sold. The buyer expressly agrees to indemnify and hold harmless Rough Country, LLC for all claims resulting directly or indirectly from the purchase, ownership, or use of the items.

