

921505000B

ROUGH COUNTRY

SUSPENSION SYSTEMS®



505INSTBAG2

FORD 2019 Ranger 6" Lift Kit

THANK YOU FOR CHOOSING ROUGH COUNTRY FOR YOUR SUSPENSION NEEDS.

Rough Country recommends a certified technician install this system. In addition to these instructions, professional knowledge of disassemble/reassembly procedures as well as post installation checks must be known. Attempts to install this system without this knowledge and expertise may jeopardize the integrity and/or operating safety of the vehicle.

Please read instructions before beginning installation. Check the kit hardware against the parts list. Be sure you have all needed parts and know where they go. Also please review tools needed list and make sure you have needed tools.

PRODUCT USE INFORMATION

▲WARNING The taller a vehicle is, the easier it will roll. We strongly recommend, because of rollover possibility that seat belts and shoulder harnesses should be worn at all times. Avoid situations where a side rollover may occur.

▲WARNING Generally, braking performance and capability are decreased when larger/heavier tires and wheels are used. Take this into consideration while driving. Do not add, alter, or fabricate any factory or after-market parts to increase vehicle height over the intended height of the Rough Country product purchased. Mixing component brands is not recommended.

Rough Country makes no claims regarding lifting devices and excludes any and all implied claims. We will not be responsible for any product that is altered. If questions exist we will be happy to answer them concerning the design, function, and correct use of our products.

This 6" suspension system was developed using a 305/55-R20 tire, on a 20 x 9 +12mm wheel. We recommend after-market wheels to not exceed 6 inches of back spacing. The factory 17 and 18 inch wheels are not applicable with this kit. Due to manufacturing, dimension variances, and inflation, all tire and wheel combinations should be tested prior to installation on all oversized / wider than stock tires.

▲NOTICE Vehicles will require the EPAS (Electronic Power Assist Steering) plugs to be disconnected prior to beginning installation of this kit. See installation instructions. Failure to disconnect these plugs may result in damage to the EPAS module resulting in an error message being displayed, which will require replacement of the EPAS module

▲NOTICE DEALER AND VEHICLE OWNER

Any vehicle equipped with any Rough Country product should have a "Warning to Driver" decal installed on the inside of the windshield or on the vehicle's dash. The decal should act as a constant reminder for whoever is operating the vehicle of its unique handling characteristics.

TOOLS NEEDED:

8mm	Socket and Wrench	Reciprocating Saw
10mm	Socket and Wrench	Hammer
13mm	Socket and Wrench	Brake Caliper Hooks
15mm	Socket and Wrench	Ratchet
17mm	Socket and Wrench	Punch
18mm	Socket and Wrench	Sander
19mm	Socket and Wrench	Paint Pen
21mm	Socket and Wrench	Torque Wrench
22mm	Socket and Wrench	Floor Jack
24mm	Socket and Wrench	Wheel chocks
36mm	Socket and Wrench	Band Clamp Pliers
9/16	Socket and Wrench	Jack Stands
T45 Torx Bit		6mm Allen



Box Kit

505BOX1

Dr Front Diff Drop Bracket-1
Rear Diff Mount-1
Dr Sway Bar Drop Bracket-1
Pass Sway Bar Drop Bracket-1
Cam Block Off Plate-6
Dr Front Brake Line Bracket
Pass Front Brake Line Bracket-1
Front Drive Shaft Spacer-1
Carrier Bearing Bracket-1
Rear Brake Line Bracket-1
U-Bolts-4
Rear Blocks-2
Lower Skid Plate-1
505INSTRBAG2
505BAG1
505BAG2
505BAG3
9/16BAG

505BOX2

Front Crossmember-1
Rear Crossmember-1

505BOX3

Dr Strut Spacer-1
Pass Strut Spacer-1
10MMStud Bag-2

505BOX4

Dr Knuckle
Pass Knuckle

20209-Rear N3 Shock

TBA-N3 Strut

TBA-Rear V2 Shock

TBA-Vertex Coilover

TBA-Rear Vertex Shock

Kit Bags

505INSTRBAG2

Instruction Sheet-1
Warning to Driver Sticker-1

505BAG1-Front Kit Bag

For Rear Differential Drop Bracket:

9/16-12 x 2 Hex Head Bolt-2
9/16 SAE Washer-4
9/16-12 Nylock Nut-2

For Skid Plates:

3/8" Flat Washers-4
3/8" x 1" Bolts-4

For Dr and Pass Sway Bar Drops:

7/16-14 x 1.25 Hex Head Bolt-4
7/16 SAE Flat Washer-8
7/16-14 Nylock Nut-4

For Front Differential:

M16-2.0 x 120mm Bolt-1
5/8 SAE Flat Washer-2
M16-2.0 Nylock Nut-1
3/8-16 x 1 Hex Head Bolt-2
3/8 SAE Flat Washer-2
3/16" Vent Hose-1
3/16" Vent Tube Connector-1

For Front Crossmember:

M16-2.0 x 120mm Hex Head Bolt-2
5/8 SAE Flat washer-4
M16-2.0 Nylock Nut-2

For Rear Crossmember:

M16-2.0 x 120mm Hex Head Bolt-2
5/8 SAE Flat washer-4
M16-2.0 Nylock Nut-2

For Front Brake Line Brackets:

7/16-18 x 1 Hex Head Bolts-2
7/16 SAE Flat Washers-2
7/16-18 Flange Lock Nut-2

Kit Bags

505BAG2-Rear Hardware

For Rear Brake Line Bracket

5/16-18 x 1 Hex Head Bolt-2
5/16 SAE Flat Washer-2
5/16-18 Flange Nut-2

For Rear Shock

1/2" SAE Washer-4

For Carrier Bearing

10mm-1.5 x 60mm Hex Head Bolt-2
3/8 SAE Washers-2
7/16 Lock Washer-2

505BAG3-Cam Bolt assembly

M16 Ranger Cam Bolt assembly Front-2
M16 Ranger Cam Bolt assembly Rear-2

For Rear Block

9/16 x 2 1/2 x 10 1/2 Square

9/16BAG-U-bolt Bag

9/16" Washers-8
9/16" Nuts-8

10MMSTUDBAG-1-Upper Strut Spacer Bag

10mm Stud-6
10mm Flange Nuts-6
10mm Nut-1
1/2" Jam Nut-1

INSTALLATION INSTRUCTONS

1. Chock the rear wheels and jack up the front of the vehicle.
2. Place jack stands under the frame rails and lower onto jack stands.
3. Remove the wheels/tires using a 19mm socket.
4. Remove the 4 bolts from the front skid plate, Set aside the front skid plate and hardware for reuse. Remove the 2 bolts in the rear skid plate, use a 15mm socket. **See Photos 1 and 2.**

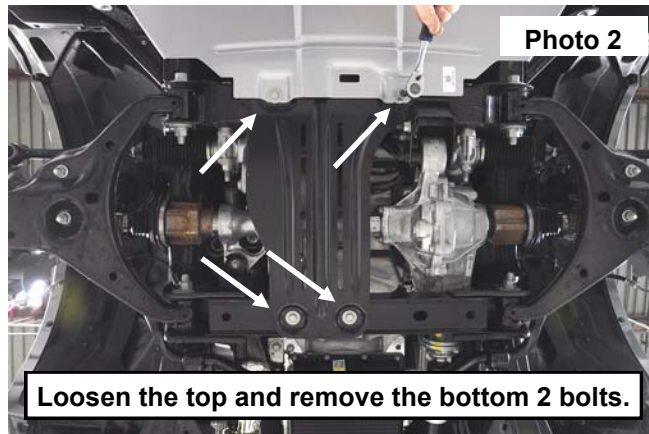

5. Remove the (3) EPAS (Electronic Power Assist Steering) Plugs as shown located on the steering assembly by the front differential. **See Photos 3 and 4.**

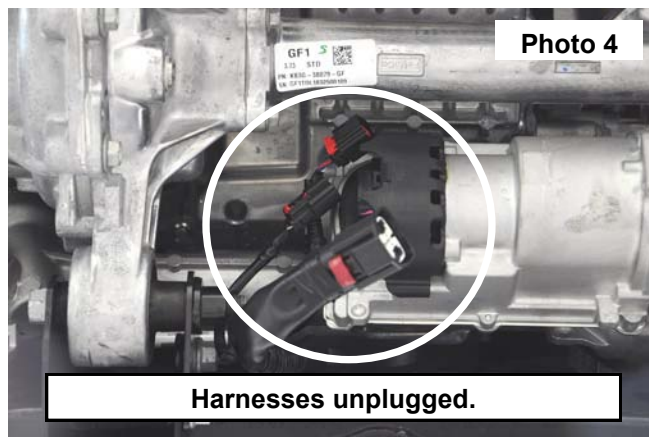
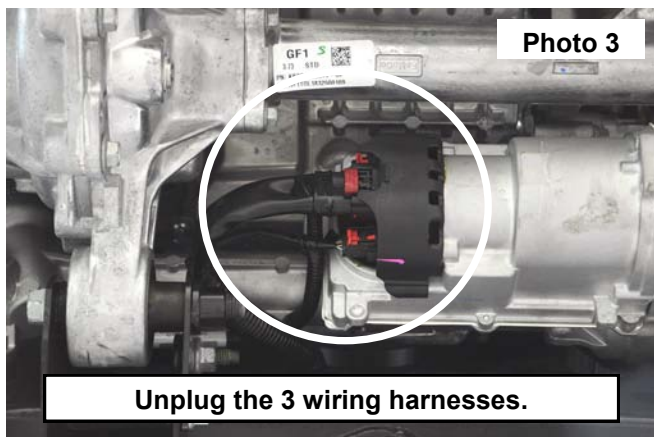

6. Loosen the nut on the tie rod end, using a 15mm socket. Use a hammer to unseat the taper by striking the end of the knuckle, finish removing the nut. **See Photo 5.**
7. Remove the ABS wire bracket from the front side of the knuckle, using an 8mm socket. Retain hardware for reuse. **See Photo 4.**

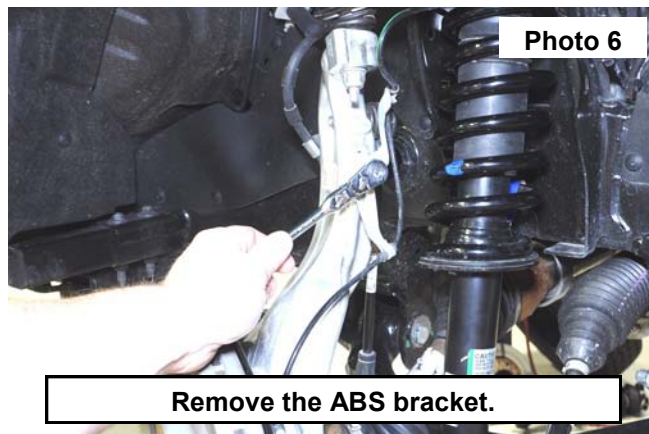
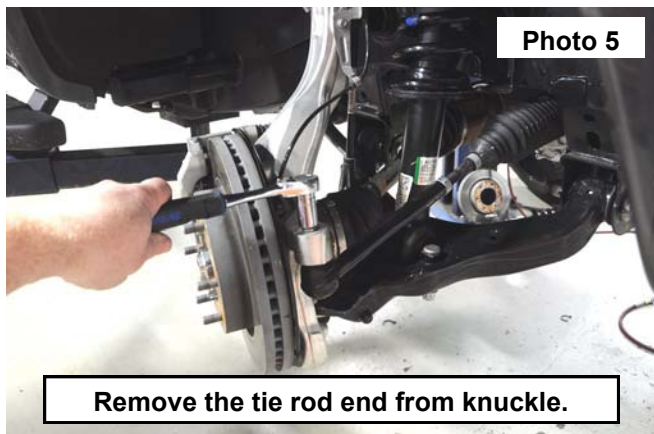

- Remove the bolt attaching the ABS line to the knuckle, use an 8mm socket, then remove the sensor from the knuckle.. **See photo 7.** Retain hardware.
- Remove the bolt attaching the brake line bracket to the knuckle, using a 10mm socket. **See Photo 8.** Retain hardware.

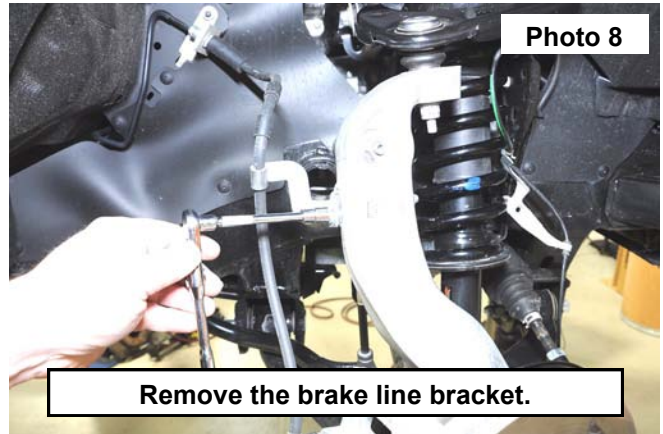
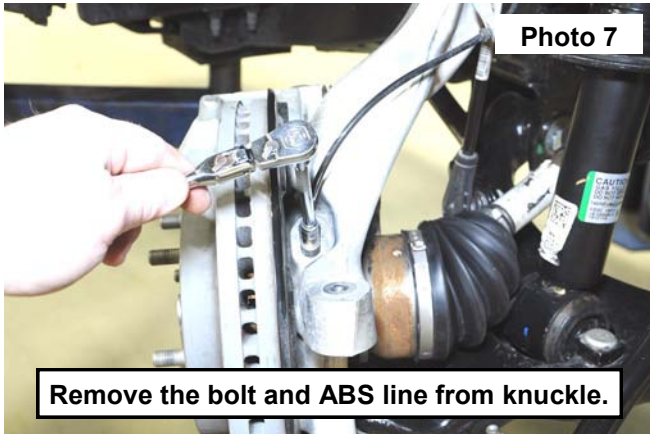

- Remove the sway link nut from the knuckle, using a 18mm socket. Retain hardware. **See Photo 9.** Remove sway link from knuckle.
- Remove the 2 bolts attaching the brake caliper to the knuckle, carefully remove the caliper from the rotor and hang by a steel hook in a safe place. **See Photo 10.** Retain hardware. **Do not hang caliper by the brake line.**

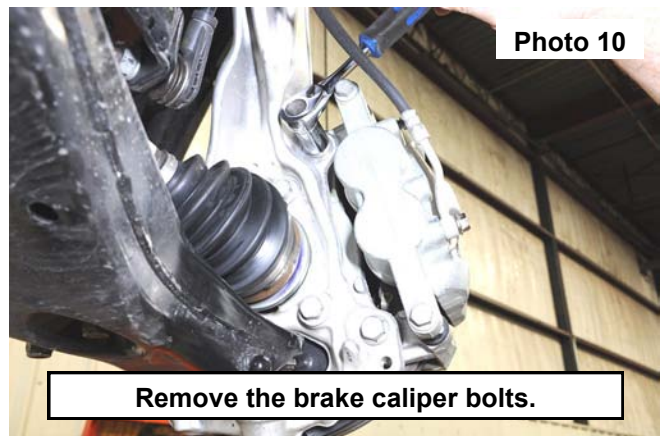

- Remove the rotor from the hub, set aside for reuse. **See Photo 11.**
- Using a 36mm socket, remove the axle nut from the hub. Retain hardware for reuse. **See Photo 12.**

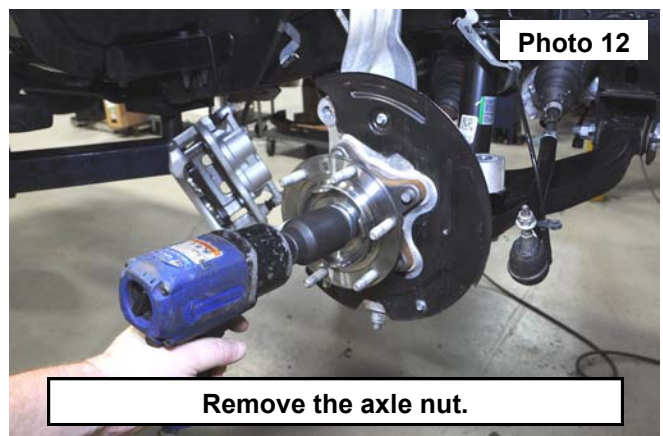
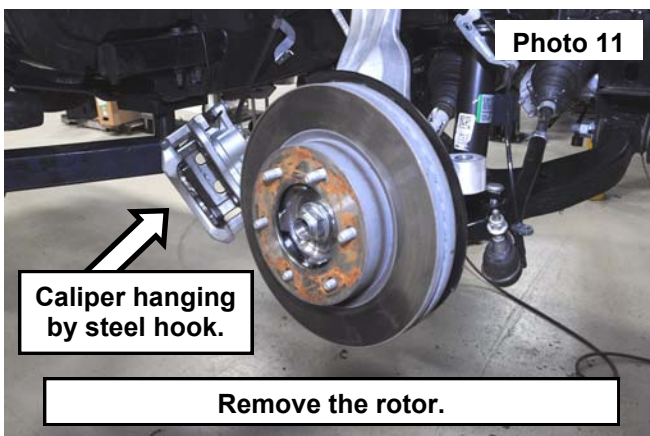

14. Unseat the axle from the hub, using a punch and a hammer. **See Photo 13. Do Not Damage Threads.**
15. Loosen the nut on the upper ball joint, using an 18mm wrench. **See Photo 14.**

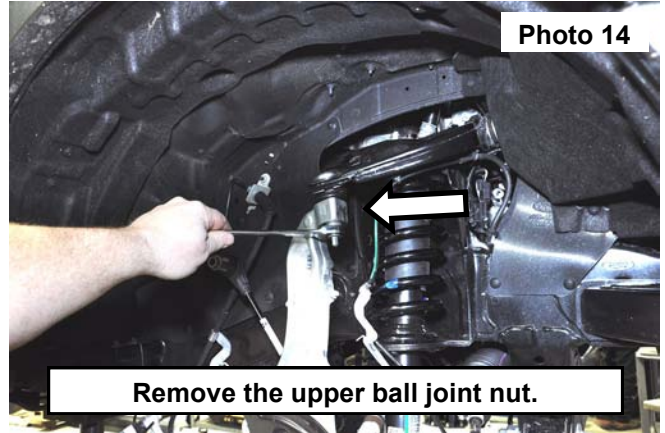

16. Strike the front of the knuckle using a hammer to release the taper, remove the ball joint nut. **See Photo 15.** Retain hardware for reuse.
17. Lean the knuckle outward, removing the axle from the knuckle. **See Photo 16. Do not let the axle over extend or droop down. Damage may occur to the axle and axle boot.**

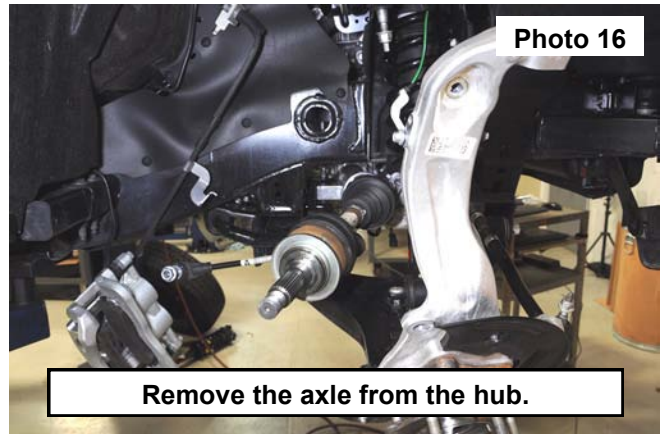
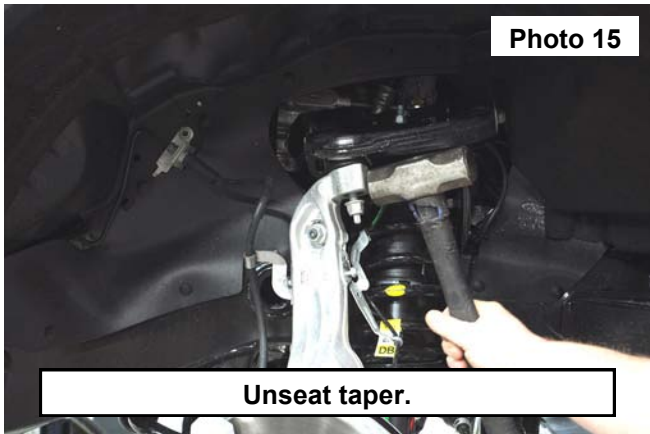

18. Loosen the lower ball joint nut using a 21mm socket, use a hammer to unseat the taper by striking the end of the knuckle, finish removing the nut. **See Photo 17.**
19. Remove the knuckle and hub assembly from the vehicle, set aside for later use.
20. Remove the 2 nuts from the bottom of the strut. Use a 18mm socket. **See Photo 18.** Retain for later use.

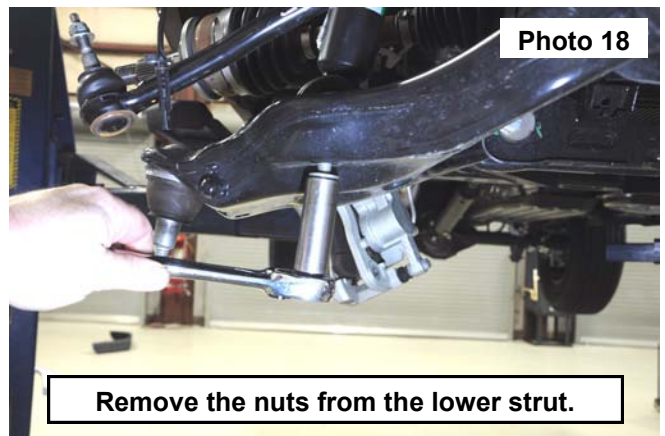

21. Remove the cam bolts in the lower control arm, using a 21mm wrench and a 24mm wrench. **See Photo 19.** Retain hardware for reuse.
22. Remove the lower control arm, set aside for reuse.
23. Using a paint pen, mark the outer stud on the strut.
24. Remove the 3 nuts on the top of the strut, using a 15mm wrench. **See Photo 20.** Retain hardware for reuse.

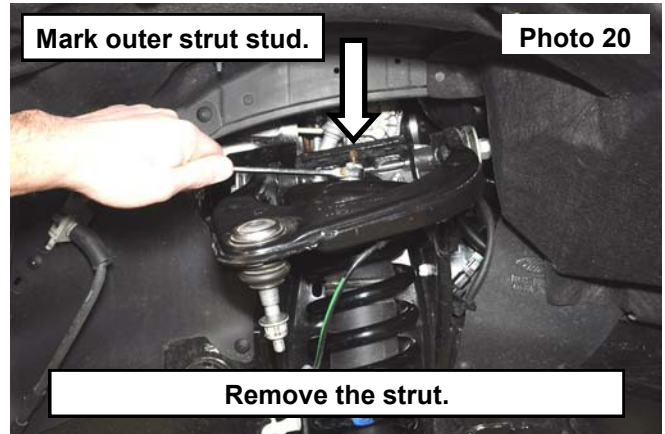
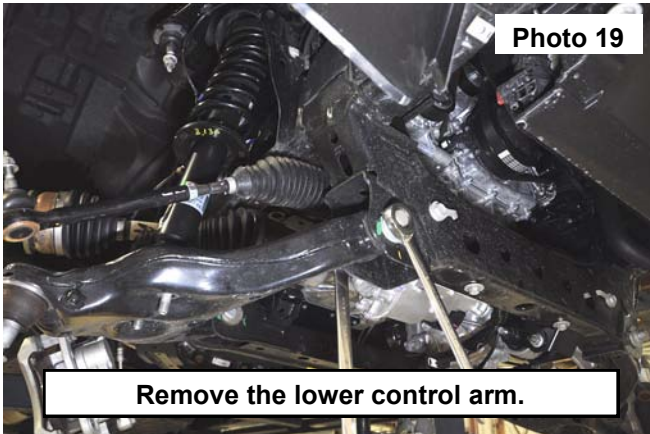

25. Repeat steps 6 — 24 on the opposite side of the vehicle.
26. Using a paint pen, mark a straight line on the drive shaft and the yoke. **See Photo 21.**
27. Using a T45 Torx, remove the 6 bolts from the drive shaft. **See Photo 22.** Retain hardware for reuse.

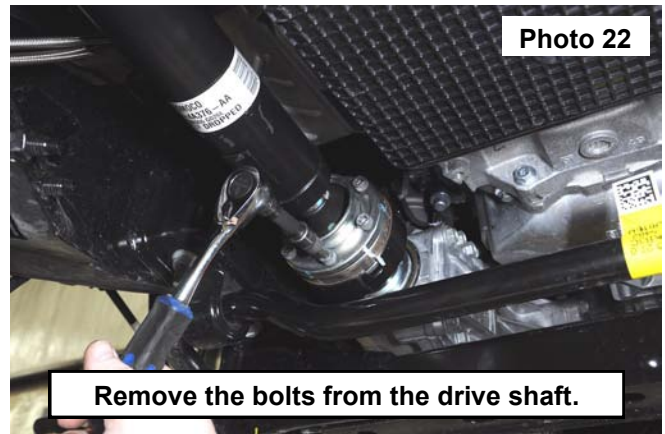

28. Remove the 2 bolts and 2 nuts on each side of the sway bar mount to the frame, using an 18mm socket. **See Photo 23.** Retain sway bar and hardware for reuse.
29. Support the diff. using a jack.
30. Remove the passenger side rear diff bolt, using a 13mm socket. **See Photo 24.** Remove the flag nut as shown in **Photo 24A.**

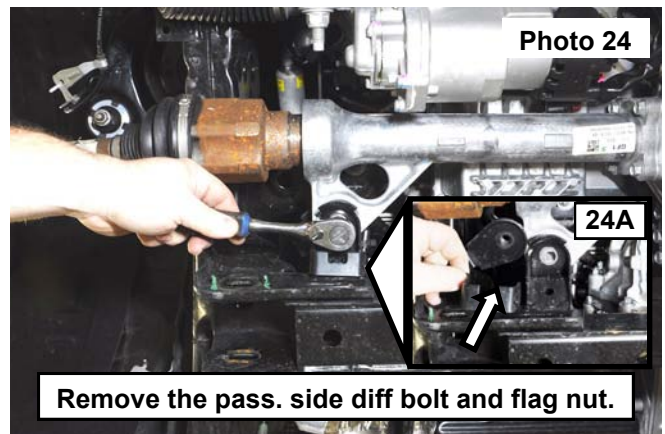
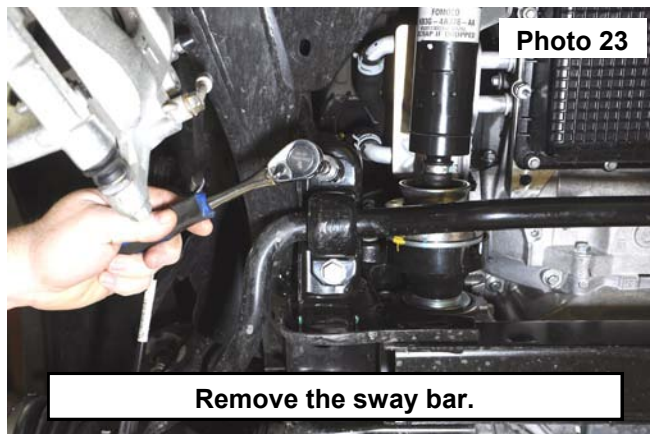

31. Remove the 2 rear driver side diff bolts, located above the yoke. Use a 18mm socket. Retain hardware. **See Photo 25.**
32. Remove the bolt in the front of the diff, using a 21mm socket. **See Photo 26.** Retain hardware for reuse. **NOTE:** The nut is welded into the removeable diff mount plate.

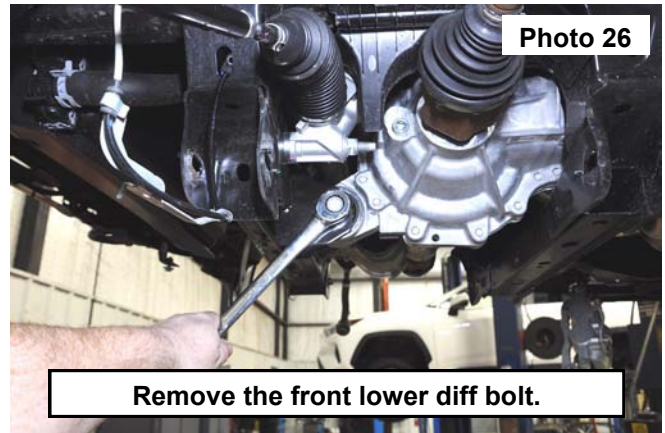
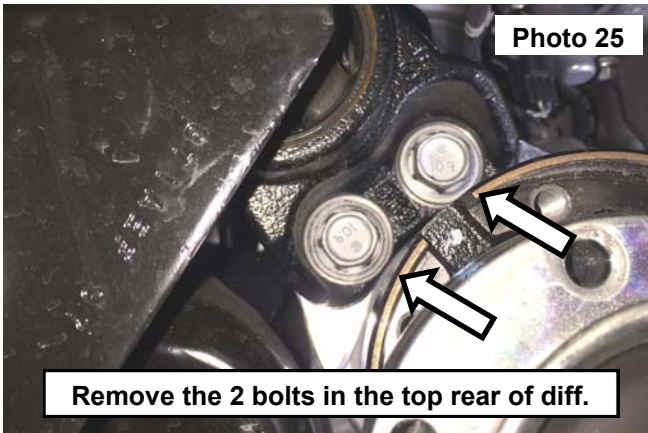

33. Remove the diff mounting plate, using an 18mm socket. **See Photo 27.** Retain hardware for reuse.
34. Remove diff by rotating the pinion up while lowering diff down.
35. Use the supplied template on the rear crossmember. Use a paint pen to mark the cut line on all 4 corners of the cross member. **See Photos 28 and 29.**

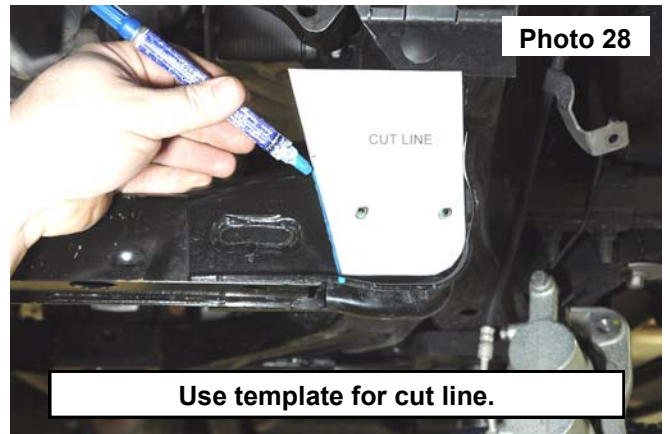
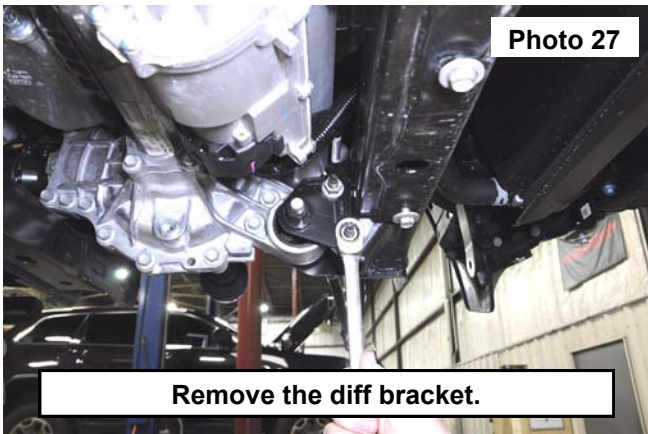

36. Use a reciprocating saw to trim the lines made on the crossmember, remove the center of the rear crossmember. **See Photo 30.**

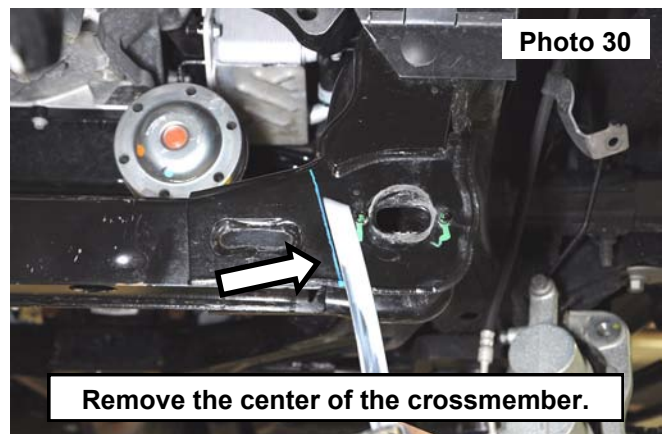
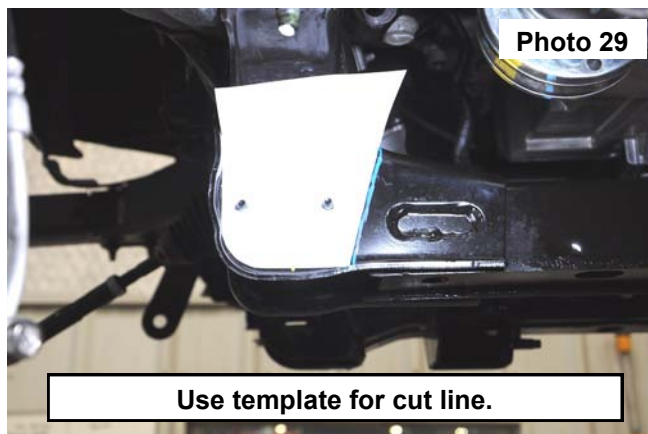

37. Remove the center of the crossmember. **See Photo 31.**
38. Locate the supplied template, fold the dotted lines to fit onto the profile of the control arm mount and trim the holes to fit over the alignment tabs. **See Photo 32.**
39. Use a paint pen, transfer the out side of the template onto the control arm mount.

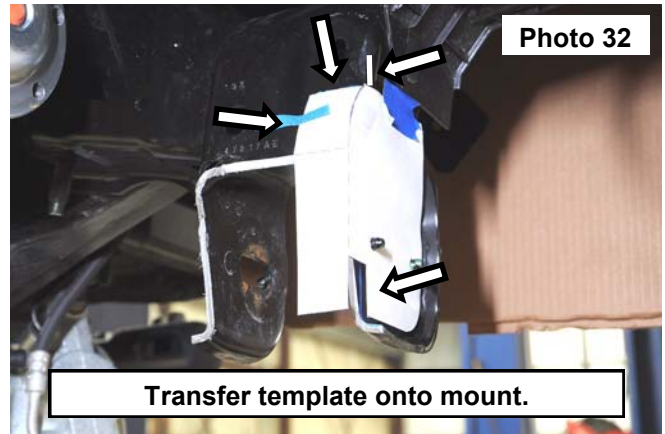
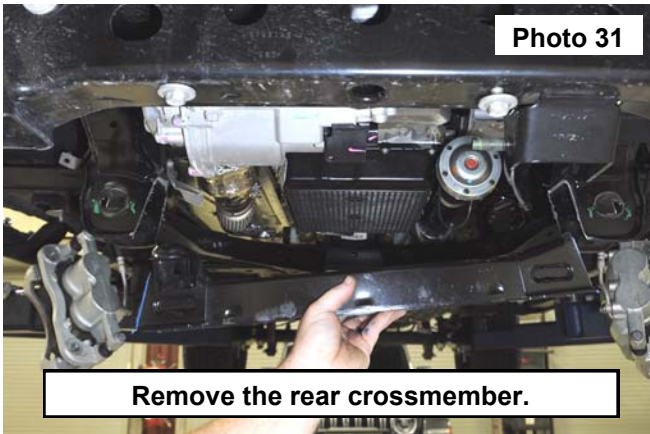

40. Remove the template and connect the front side of the marks using a straight edge. **See Photo 33.**
41. Use a reciprocating saw to trim the lines made on the mount. **See Photo 34.**

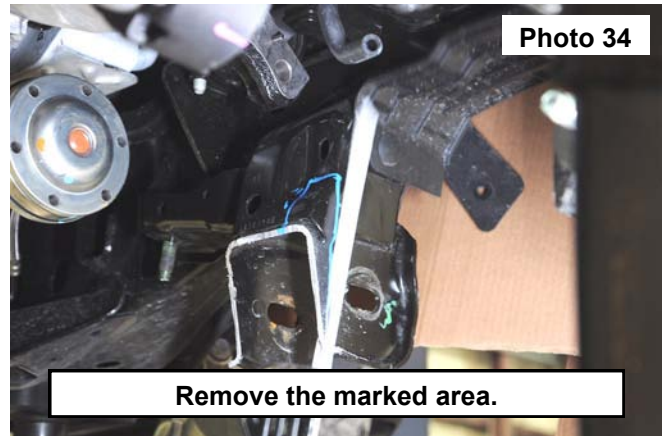
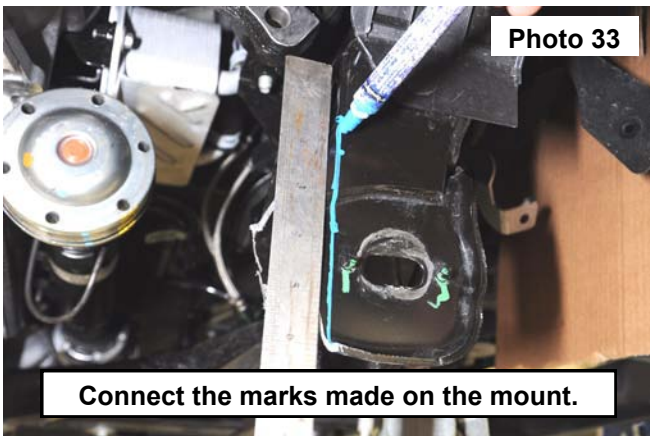

42. Sand and smooth all trimmed areas on both sides of the control arm mounts. Paint these areas to prevent rust. **See Photo 35.**
43. Remove 1/4 inch from the top corner of the front diff mount using a sander. **See Photo 36.** Repaint the area to prevent rust.

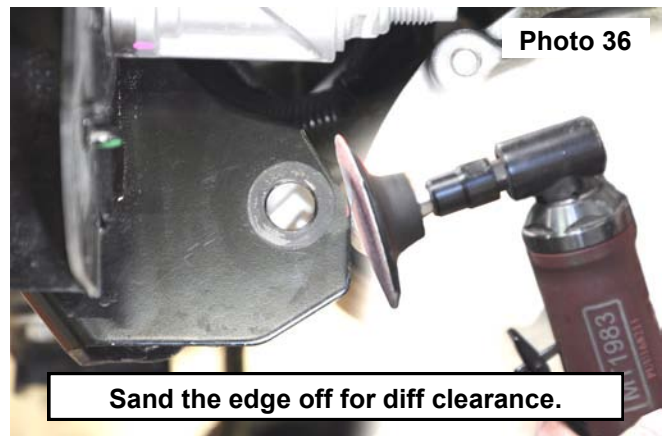
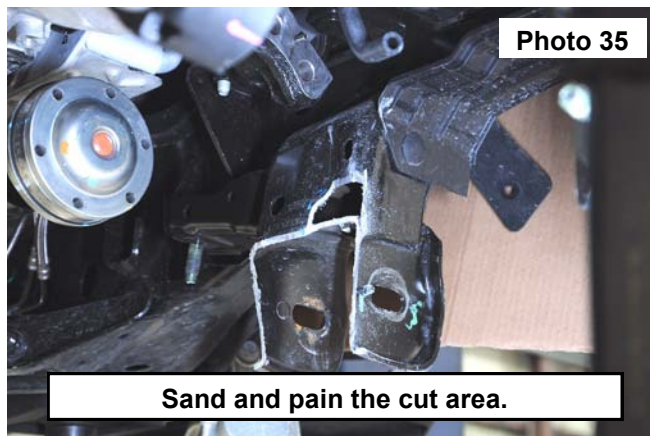

44. Remove 1/4 inch off the corner of the diff casting for clearance using a sander. See Photo 37.
45. Install the (2) 9/16-12 X 2 Hex head bolt (4), 9/16 flat washers, and (2) 9/16-12 nylock nut, in rear diff mount. See **Photos 38 and 39**. Torque to 95 ft-lbs. using a 22mm socket and wrench.

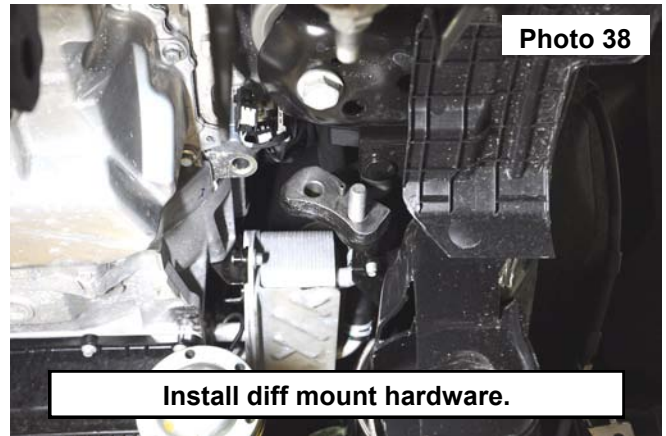
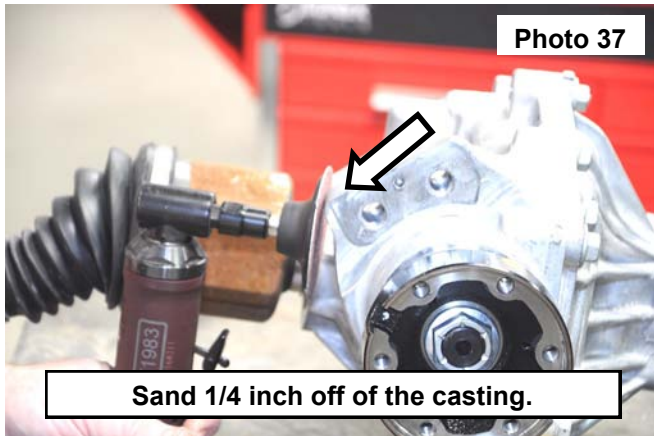

46. Install the OE front diff bracket onto the studs using the retained nuts then tighten using a 18mm wrench. See **Photo 40**.

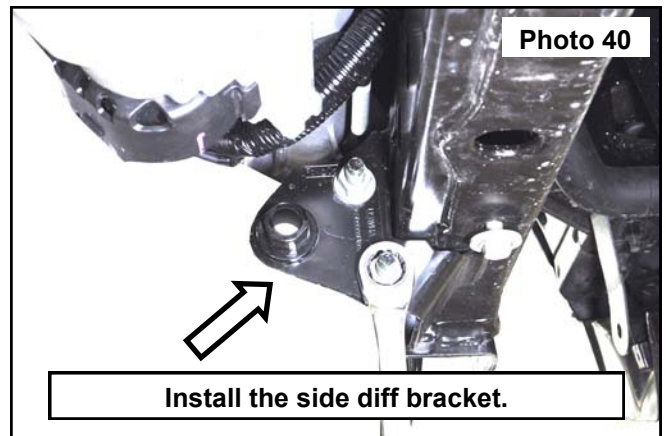
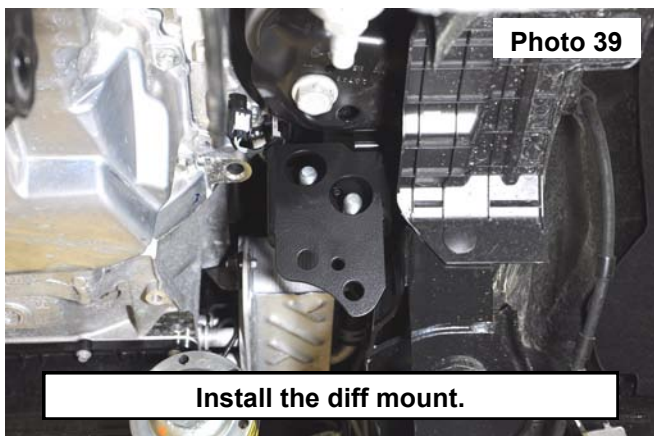

47. Install the new diff mount using the retained OE bolt. Do not tighten at this time. See **Photo 41**.
48. Install the diff into the installed mounts in the front and the rear using the 2 retained OE bolts in the rear diff mount. See **Photo 42**. Do not tighten at this time.

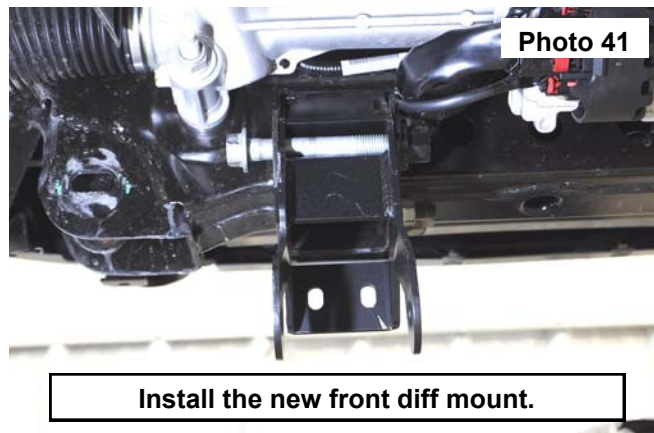

49. Install the bolt in the front diff mount using the supplied (1) 16-2.0mm X 120mm Hex head bolt, (2) flat washers, and (1) 16-2.0mm Nylock nut from. **See Photo 43.** Do not tighten at this time.
50. Install the rear cross member using the supplied cam block off plate on the alignment tabs on the front of the mount. Secure using the supplied (1) 16-2.0mm X 120mm bolt and (1) 16mm flat washer. **See Photo 44 and 45.**

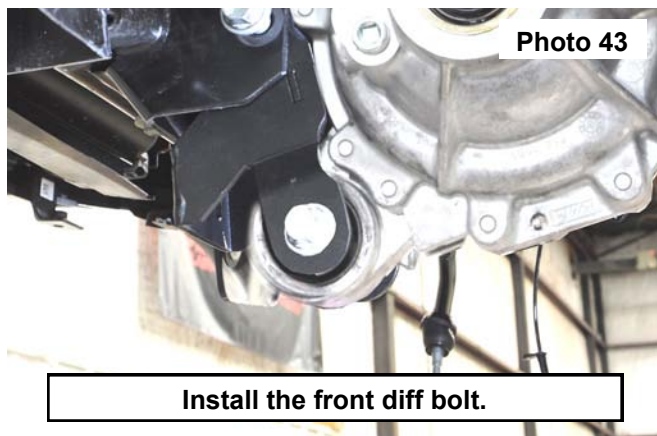

51. Install the retained OE bolt, 10mm washer, and 10-1.5mm nylock nut in the passengers side diff mount on the rear crossmember. **See Photo 46.** Do not tighten at this time.

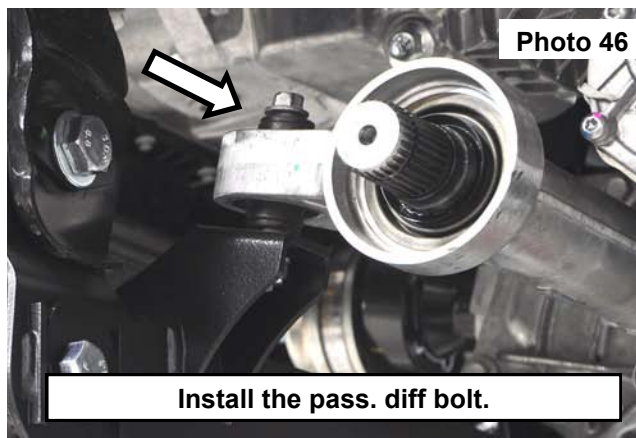
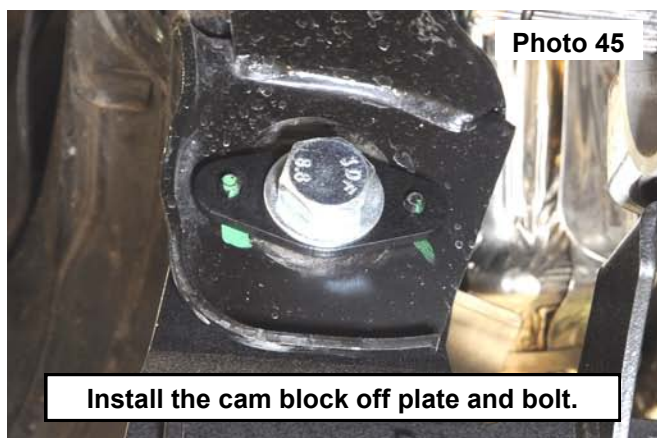

52. Install the sway bar drops for each side of the vehicle onto the crossmember bolt using (1) of the supplied 16mm flat washer and (1) 16mm-2.0mm nylock nuts. Use the retained factory nut and bolt in the top of the sway bar drop mount. **See Photo 47.** Do not tighten at this time.
53. Install the retained skid plate bolts into the factory location, then install the front cross member. **See Photo 48.** Do not tighten skid plate bolts.

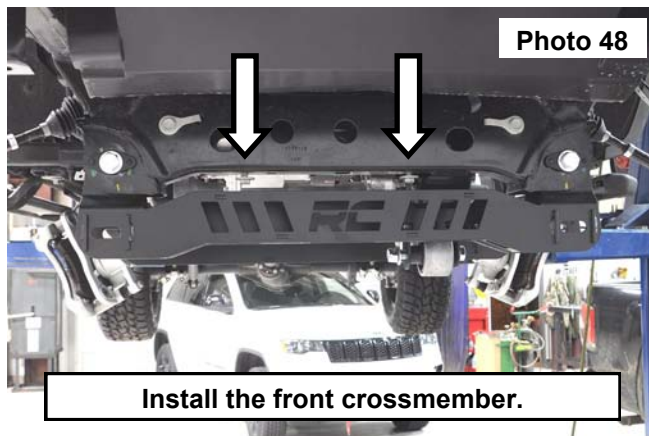

54. Install the front and rear cam block off plates onto the alignment studs. secure the crossmember and cam block off plate on each side using (1) 16-2.0 x 120mm bolt , (2) 16mm flat washers and (2) 16-2.0mm nylock nuts. **See Photos 49 and 50.** Do not tighten at this time.

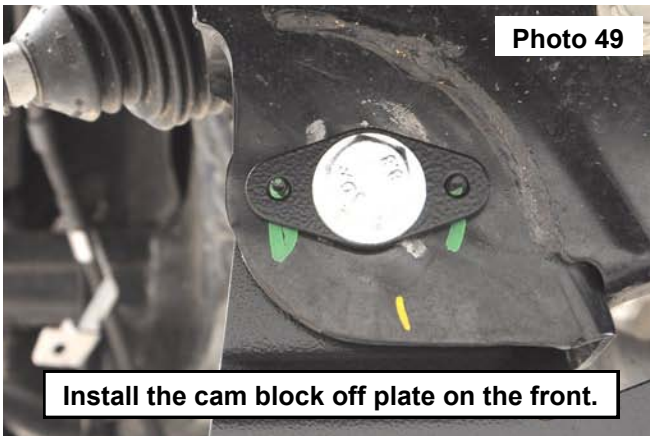

55. Install the lower control arms securing the supplied bolts and cam washers into the new crossmembers. Do not tighten and only snug the nuts and bolts using a 24mm wrench and socket. These will be tightened once the truck is on the ground. **See Photo 51.**
56. Install the front diff mount bracket onto the front crossmember using the (2) supplied 3/8-16 x 1 bolts and (2) 3/8 flat washers. Torque to 35 ft-lbs. using a 9/16 socket. **See Photo 52.**
57. At this time torque all diff hardware. Torque the 2 OE driver rear upper bolts to 100 ft-lbs. using an 18mm socket.

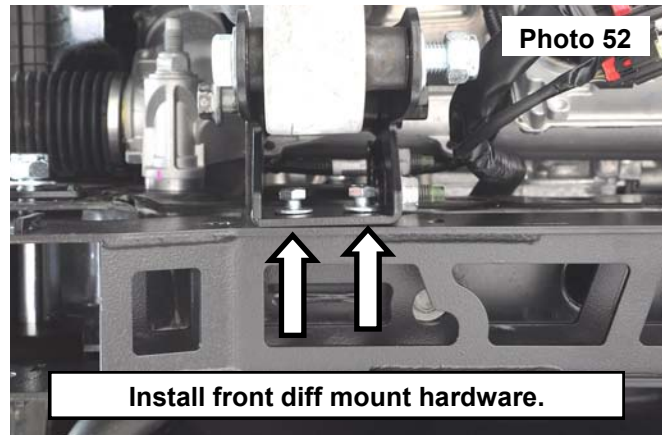
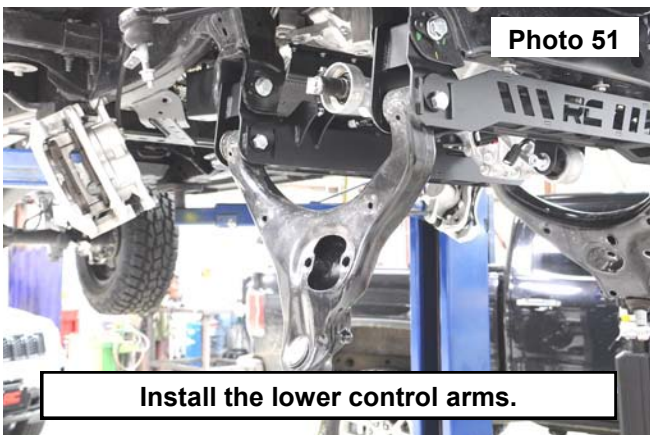

58. Rear passenger OE bolts and 10mm nut. Torque to 45 ft-lbs. using a 13mm and 17mm socket. **See Photo 53.**
59. Torque the 2 front 16mm diff mount bolts to 100 ft-lbs. using an 24mm wrench and socket. **See Photo 54.**

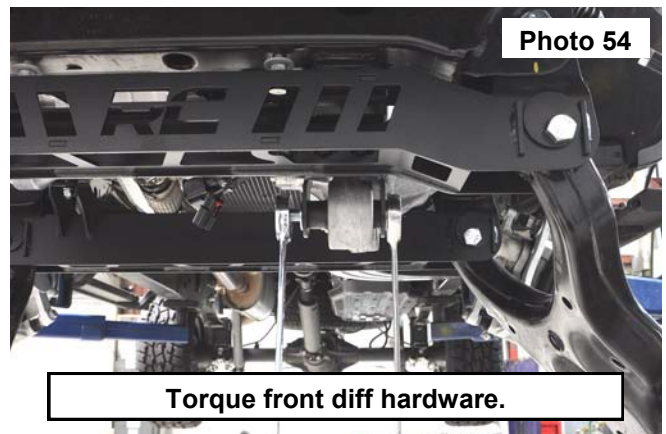

60. Torque the sway bar drop hardware to 55 ft-lbs. on each side using a 18mm socket. **See Photo 55.**
61. Torque the front and rear upper crossmember bolts to 130 ft-lbs. using a 24mm wrench and socket. **See Photo 56.**

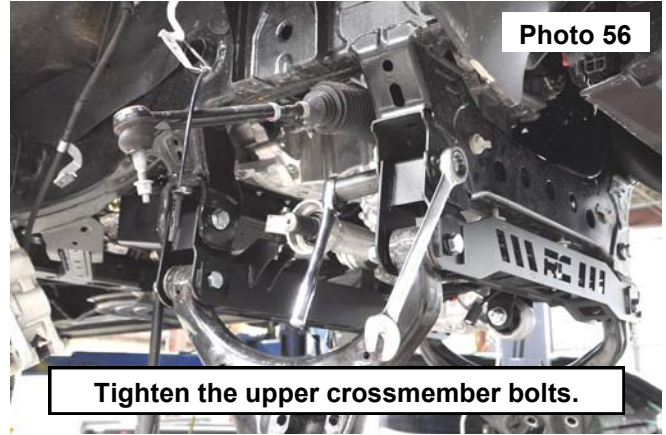
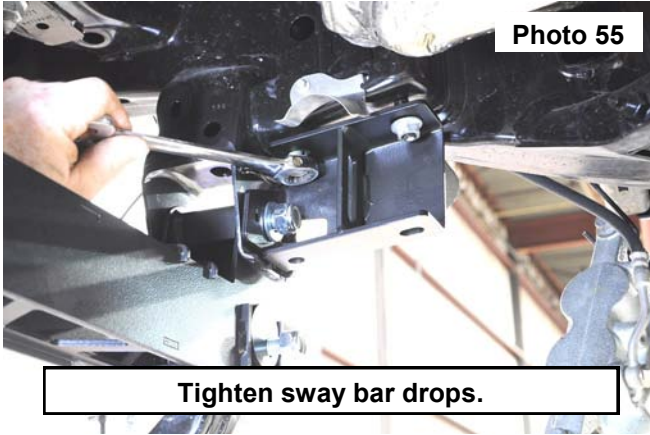

62. Install the drive shaft and drive shaft spacer. Remove the OE bolts from the 2 bolt retainers and use them with the (6) supplied 8 –1.0 x 80mm socket head bolts. Torque to 18 ft-lbs. using a 6mm allen. **See Photo 57.**
63. Install the sway bar onto the sway bar drops using the supplied (2) 7/16-14 x 1.25 hex head bolts, (4) 7/16 flat washers and (2) 7/16 nylock nuts. Torque to 45 ft-lbs. using 5/8 wrench and socket. **See Photo 58.**

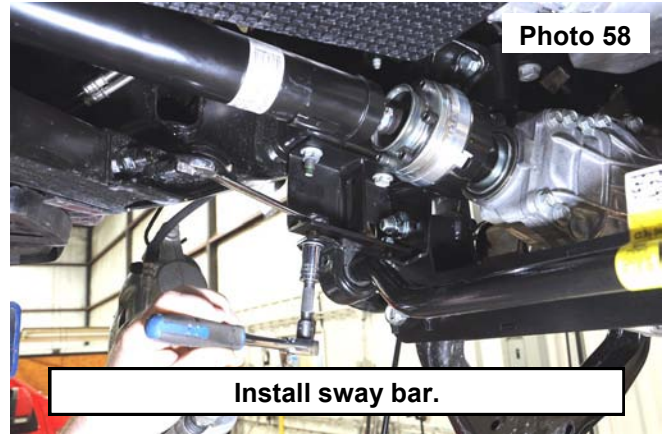
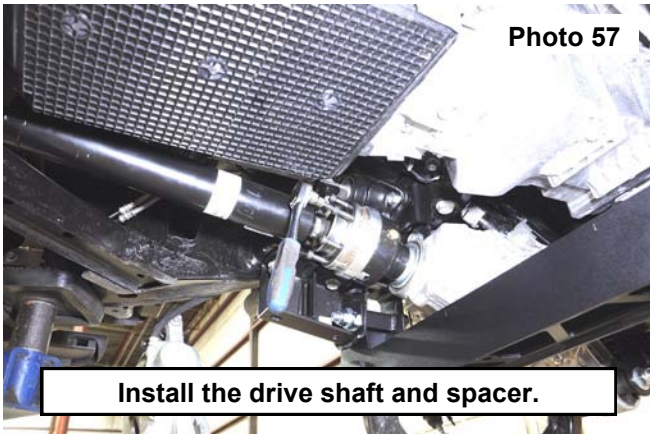

64. Install the skid plate onto the front and rear crossmembers using the (4) supplied 3/8-16 x 1 hex head bolts and (4) 3/8 flat washers. Torque to 30 ft-lbs. using a 9/16 socket. **See Photo 59 and 60.**

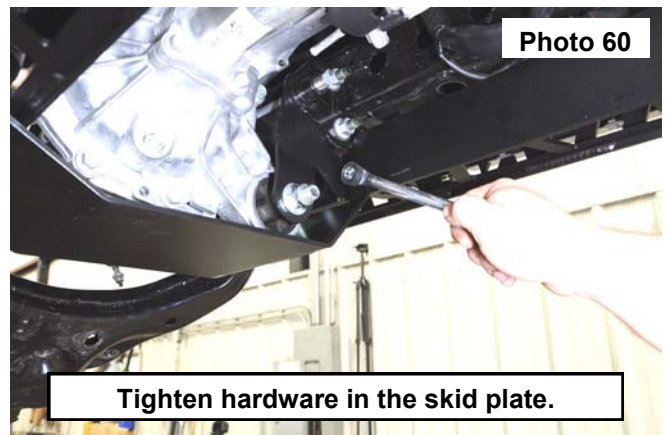
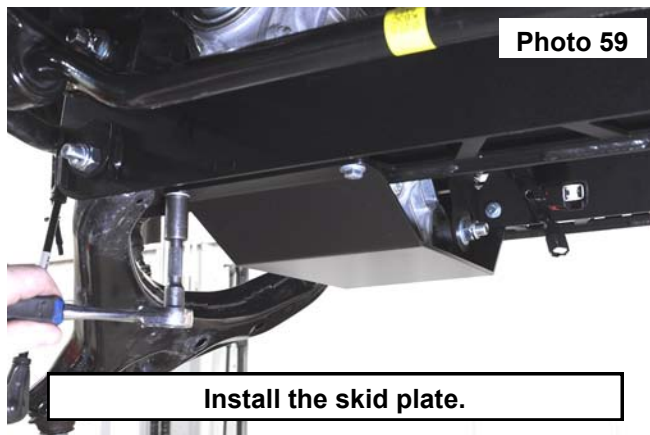

65. Identify the spacers cut into the top of each spacer is a D for the drivers side and a P for the passengers side. **See Photo 61.**
66. Install the (3) studs in the small holes in each spacer. use the supplied 1/2 inch jam nut for a spacer along with the 10mm nut using a 17mm socket to seat the stud in the top of the spacer. **See Photo 62.**

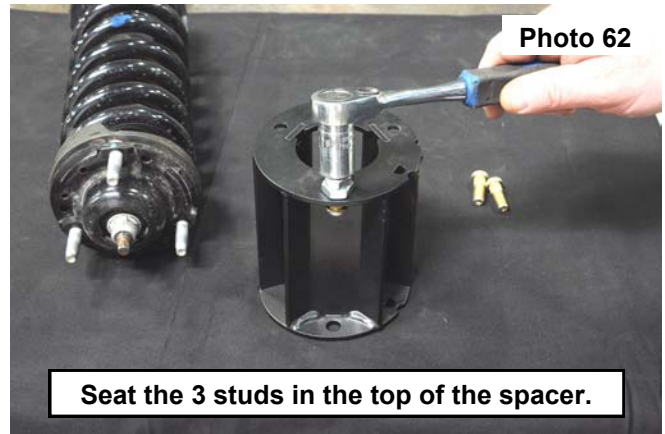
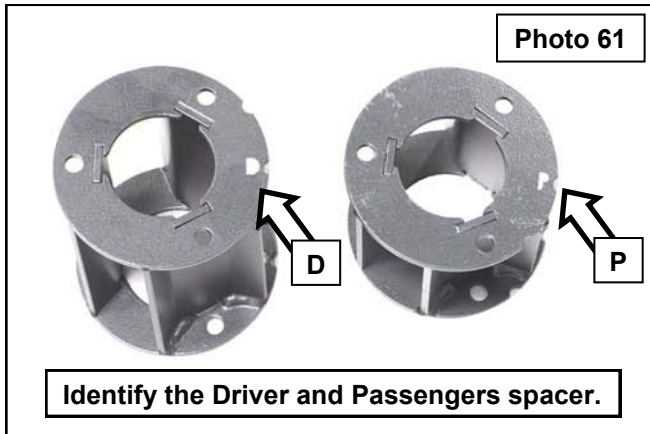

67. Install the spacer onto the top of the strut with the identifying stud, marked in step 23, opposite of the D or P (on the top of the supplied spacer), use the 3 OE nuts. Torque to 35 ft-lbs. use a 15mm socket. **See Photo 63.**
68. Install the strut, secure using the (3) supplied 10mm flange nutss on top of the strut mount. Do not tighten at this time. **See Photo 64. The stud marked in step 23 must be facing out, away from the vehicle, and the D or P on top of the spacer must be facing the frame rail of the vehicle.**

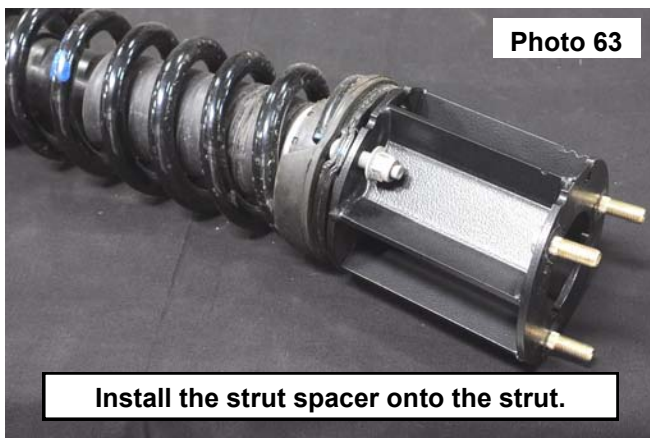

69. Raise the lower control arm up connecting the studs in the strut and secure using the (2) retained nuts. Torque to 45 ft-lbs. using a 18mm socket. **See Photo 65.** Torque strut studs to 35 ft-lbs. using a 17mm socket.
70. Remove the nut from the brake line bracket on the inner structure of the vehicle using a 13mm wrench.
71. Install the supplied brake line bracket onto the brake line using the supplied 5/16-18 x 1 hex head bolt,(2) 5/16 flat washers and a 5/16-18 nut. Torque to 15 ft-lbs. using a 13mm wrench and socket.
72. Install the brake line and bracket onto the stud on the inner structure using the retained nut. Tighten using a 13mm wrench. **See Photo 66 for steps 70-72.**

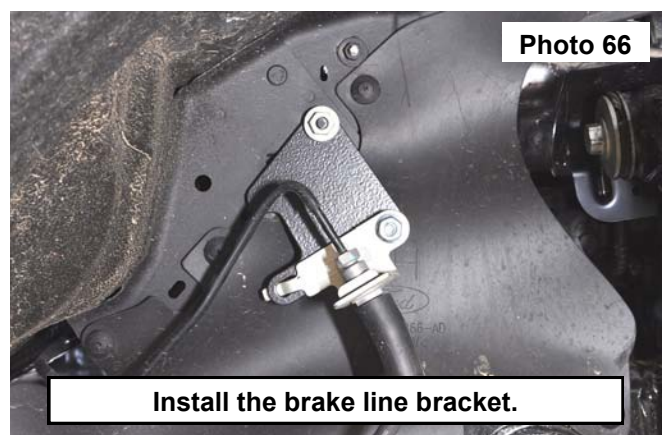
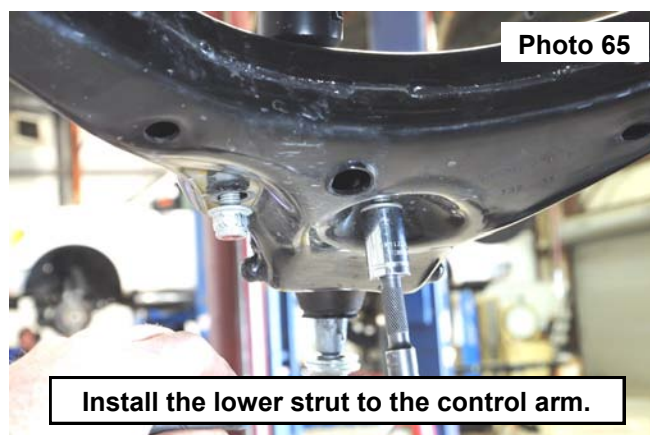

73. Remove the hub bolts in the back side of the OE knuckle using a 18mm socket. Retain bolts and hub for reuse. **See Photo 67.**
74. Remove the dust shield from the OE knuckle using a 8mm socket. Retain the bolts and dust shield for reuse. **See Photo 68.**

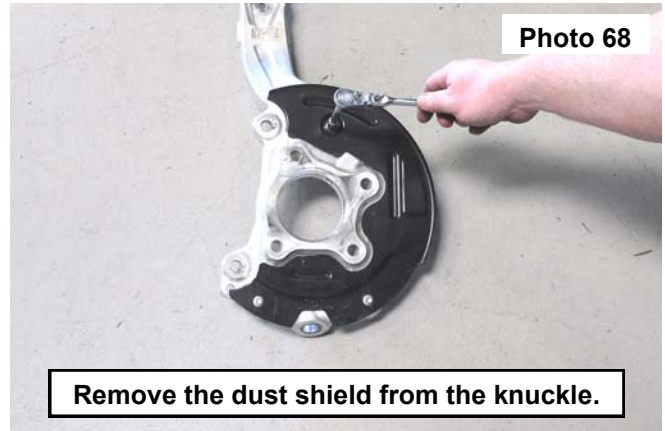
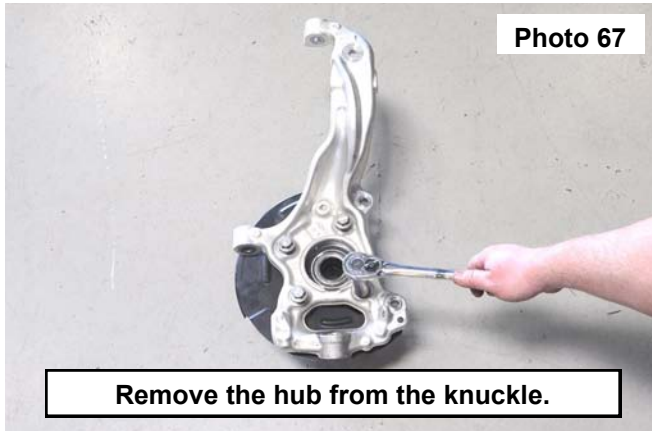

75. Install the dust shield onto the new knuckle and secure using the retained (3) bolts. Torque to 9 ft-lbs. using an 8mm socket. **See Photo 69.**
76. Install the new knuckle onto the OE hub and secure using the (4) retained OE bolts then torque to 100 ft-lbs. using a 18mm socket. **See Photo 70.**

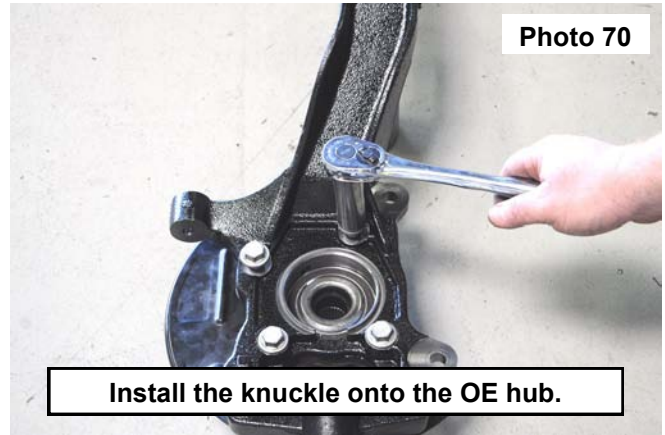

77. Install the axle at this time if it has been removed for kit installation.
78. Install the axle into the hub and the knuckle onto the lower ball joint. torque the lower ball joint nut to 40 ft-lbs. using a 21mm socket. **See Photo 71.**
79. Install the upper ball joint into the knuckle. Torque the upper ball joint nut to 40 ft-lbs. using an 18mm socket. **See Photo 72.**

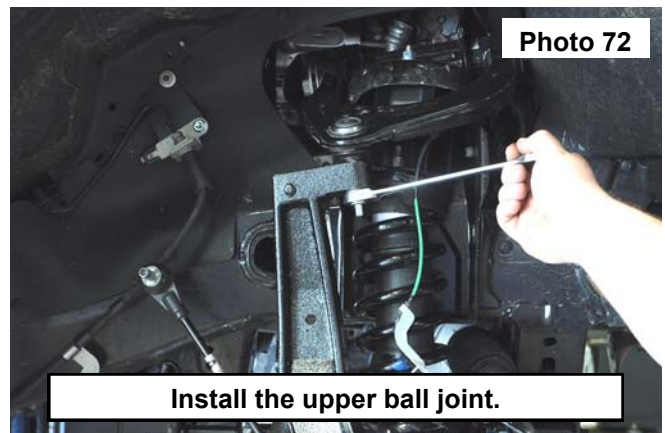
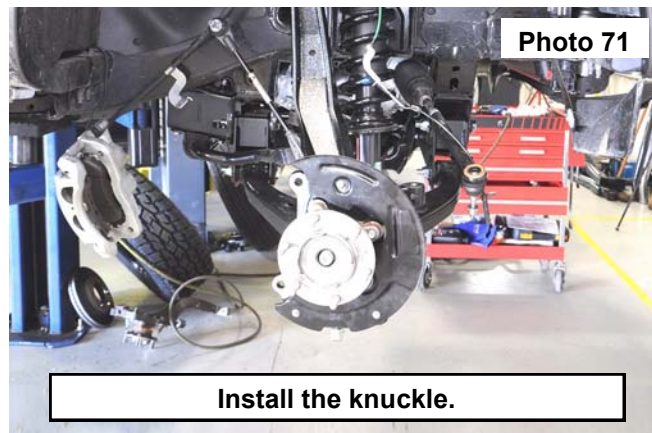

80. Install the axle nut. Apply Anti-Seize Lubricant to the threads to help seat the axle in the hub. Torque to 185 ft-lbs. use a 36mm socket. **See Photo 73.**
81. Install the rotor onto the hub and wheel studs. **See Photo 74.**

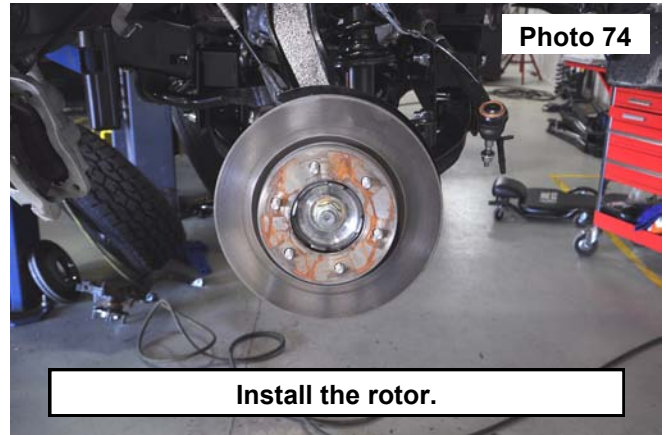
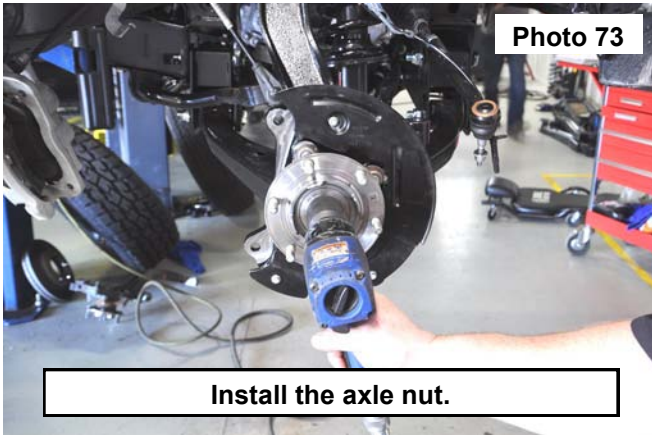

82. Install the caliper onto the rotor and the knuckle. secure using the (2) retained bolts. Torque to 130 ft-lbs. use an 18mm socket. **See Photo 75.**
83. Install the ABS sensor in the knuckle and use the retained bolt. Tighten using an 8mm socket. **See Photo 76.**

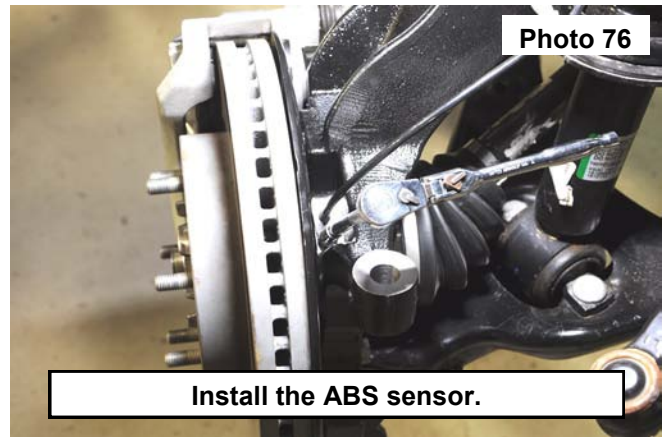
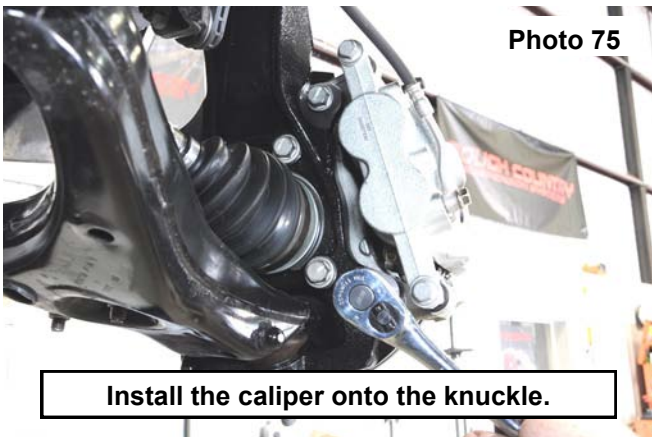

84. Install the ABS line mount onto the front side of the knuckle, secure using the retained bolt. Tighten using a 10mm socket. **See Photo 77.**
85. Install the sway bar link into the center of the knuckle, secure using the retained nut. Torque to 45 ft-lbs. using a 18mm socket. **See Photo 78.**

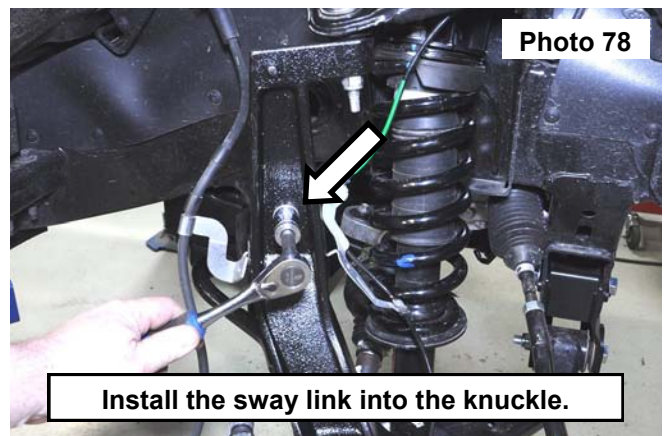
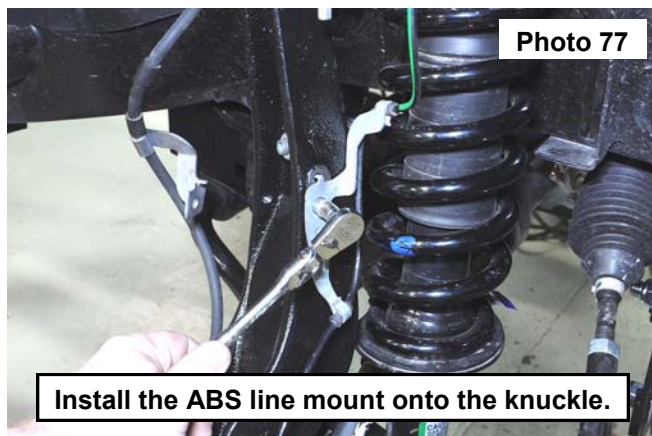

86. Install the brake line bracket onto the back side of the knuckle using the retained bolt. Tighten using a 10mm socket. **See Photo 79.**
87. Install the tie rod end into the knuckle using the retained nut. Torque to 45 ft-lbs. using a 15mm wrench. **See Photo 80.**

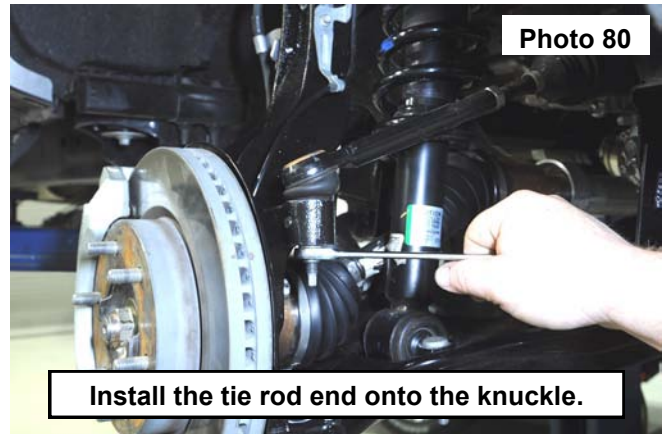
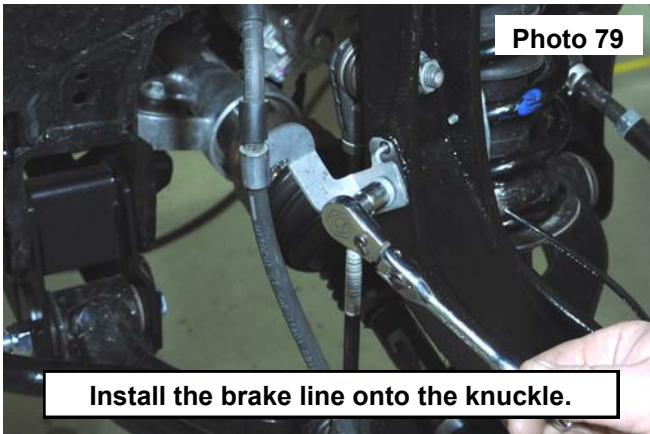

88. Install the front OE skid plate between the frame and the new crossmember, Torque the (4) bolts to 32 ft-lbs. using a 15mm socket. **See Photo 81 and 82.**

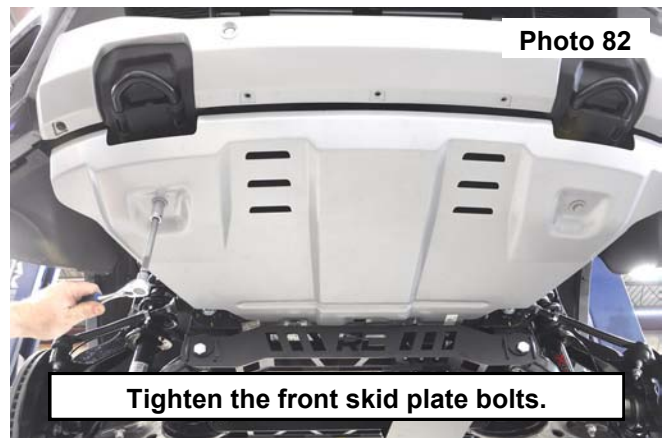
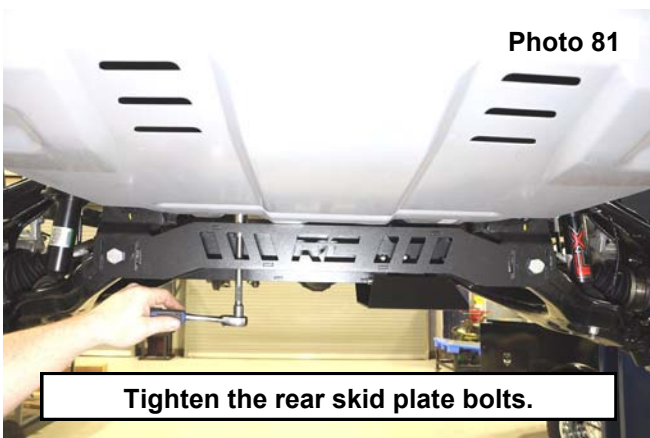

89. Install the diff vent tube extension and coupler. **See Photo 83.**
90. Connect the (3) EPAS (Electronic Power Assist Steering) plugs as shown located on the steering assembly. **See Photo 84.**

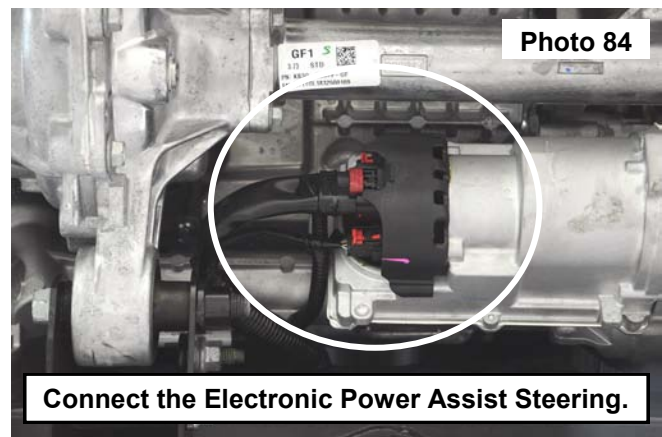
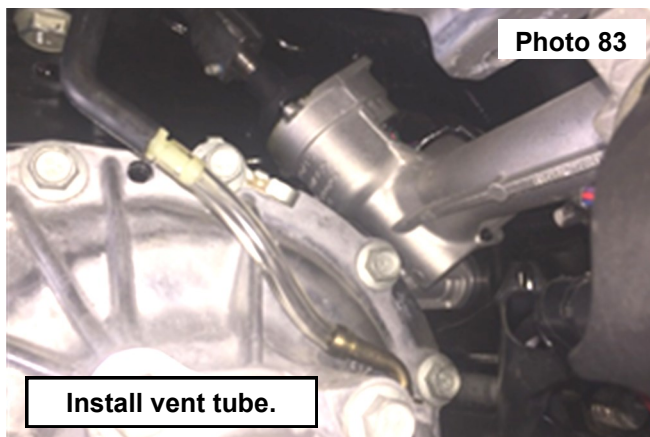

91. Install the wheels and tires onto the vehicle and tighten using a 19mm socket.
92. Using a jack raise up the front of the vehicle and remove the jack stands to lower the vehicle to the ground.
93. This vehicle will require an alignment.
94. Torque the lower control arm to 165 ft-lbs. using a 24mm wrench and socket.
95. Remove the rear wheel chocks.



1. Chock the front wheels and jack up the rear of the vehicle.
2. Place jack stands under the frame rails and lower onto jack stands.
3. Remove the wheels/tires using a 19mm socket.
4. Remove the two bolts holding the brake line bracket on frame using a 10mm socket, retain hardware for reuse. **See Photo 1.**
5. Install the rear brake line drop bracket. use the stock hardware on top and the (2) supplied 5/16-18 X 3/4 hex head bolt (2) 5/16 flat washers and (2) 5/16 nylock nuts. Torque hardware to 15 ft-lbs. using a 13mm wrench and socket. **See Photo 2.**

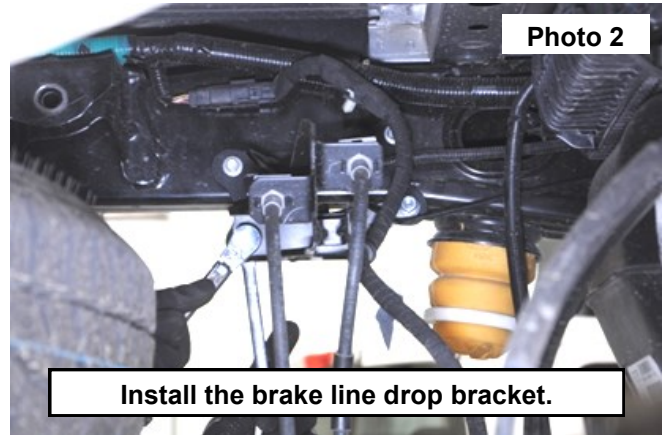
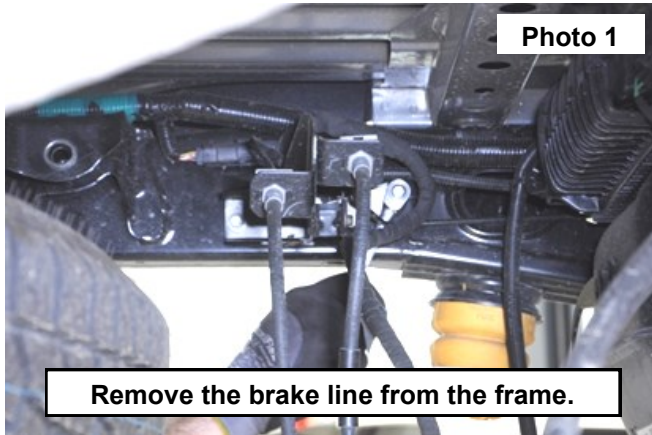

6. Support the rear axle.
7. Remove the upper and lower shock bolts using a 15mm socket. Remove shock. **See Photo 3 and 4.** Retain hardware for later use.

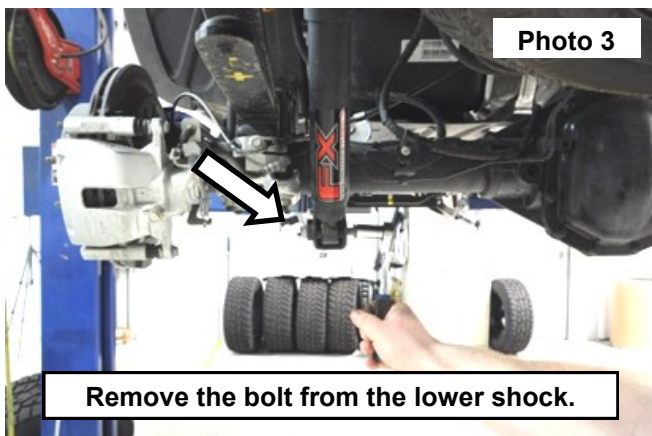

8. Remove the nuts from the U bolts using a 21mm socket. **See Photo 5.** Retain the U bolt plate.
9. If equipped with a factory leaf shim, make sure the shim is placed on **top of the supplied lift block** in the next step. Usually found on the driver side. **See Photo 6.**

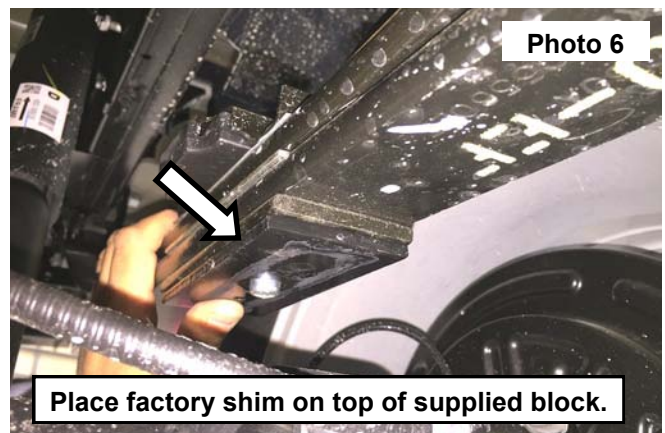
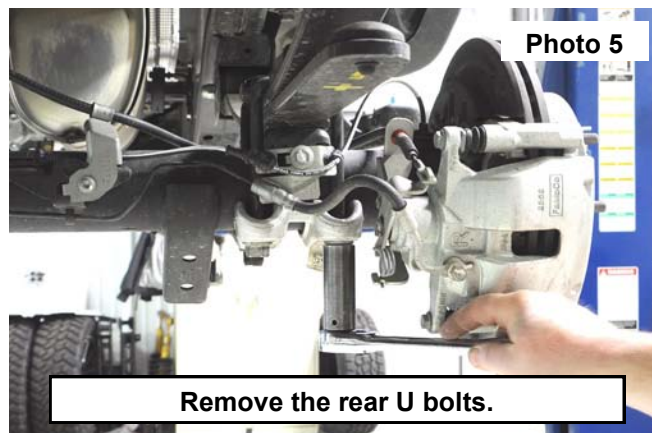

10. Locate the arrow on the rear block. the arrow will be pointing toward the front of the vehicle. **See Photo 7.**
11. Install the supplied 9/16 x 2 1/2 x 10 1/2 U bolts over the leaf springs and into the U bolt plate. secure using the supplied 9/16 flat washers and 9/16 nylock nuts on the bottom. Torque to 90 ft-lbs using a 22mm socket. **See Photo 8.**
12. Install the shock into the upper & lower mounts with the 1/2 inch washer (if needed). Secure using the retained

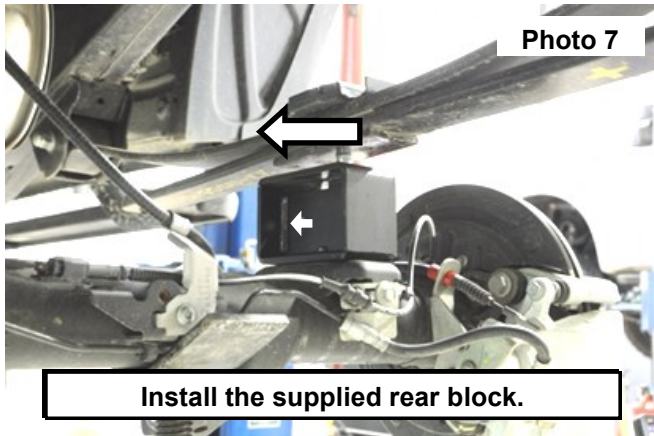

Install the supplied rear block.

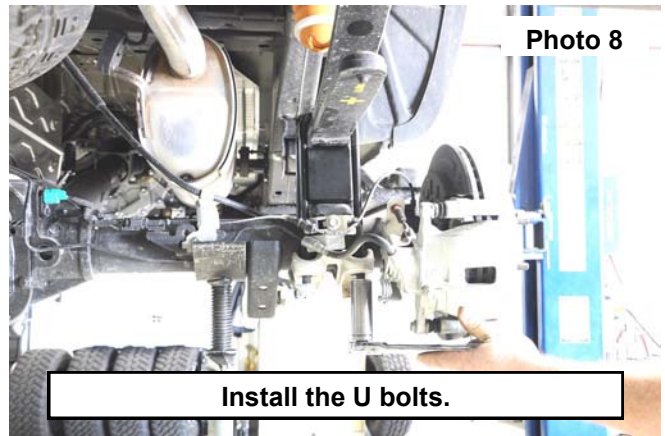

Install the U bolts.

- hardware. Torque to 80 ft-lbs. using a 15mm wrench and socket. **See Photo 9.**
13. Support the driveshaft close to the carrier bearing. Use a 15mm socket to remove the bolts from the carrier bearing. **See Photo 10.** Do not let driveshaft hang.
 14. Install the carrier bearing spacer with the tall side to the rear. **See Photo 11.**

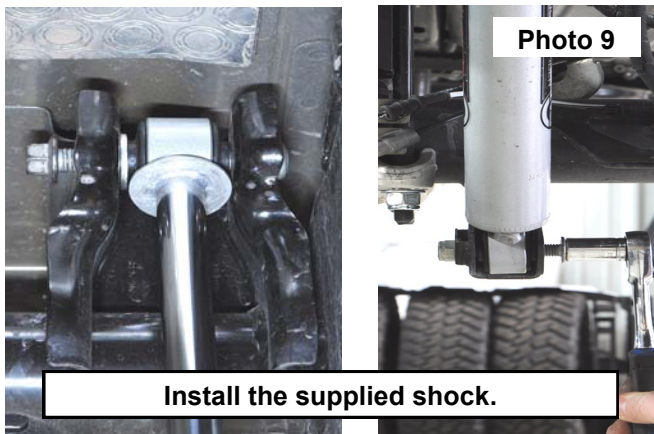

Install the supplied shock.

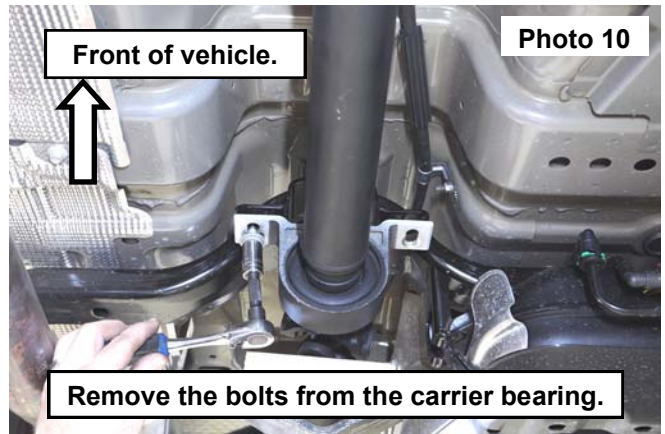

Front of vehicle.

Remove the bolts from the carrier bearing.

15. Secure the carrier bearing by installing the (2) supplied 10-1.5mm x 60mm hex head bolts, lock washers and flat washers. Torque to 32 ft-lbs. using a 17mm socket. **See Photo 12.**
16. Mark the rear stub shaft and yoke shaft for factory orientation. Loosen the front clamp. **See Photos 13 and 14.**

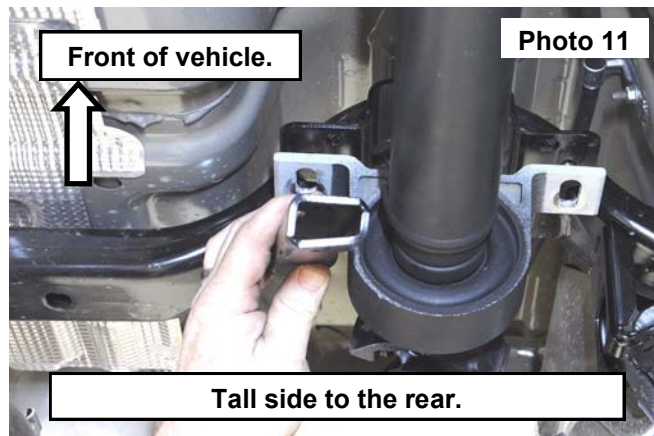

Front of vehicle.

Tall side to the rear.

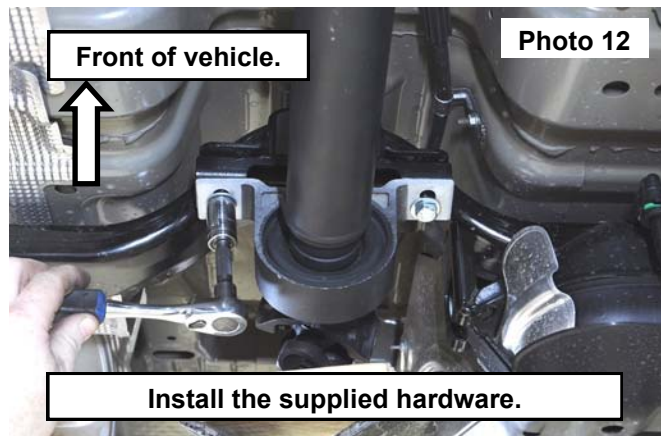

Front of vehicle.

Install the supplied hardware.

17. Mark the flange orientation at the rear pinion. See Photo 15.

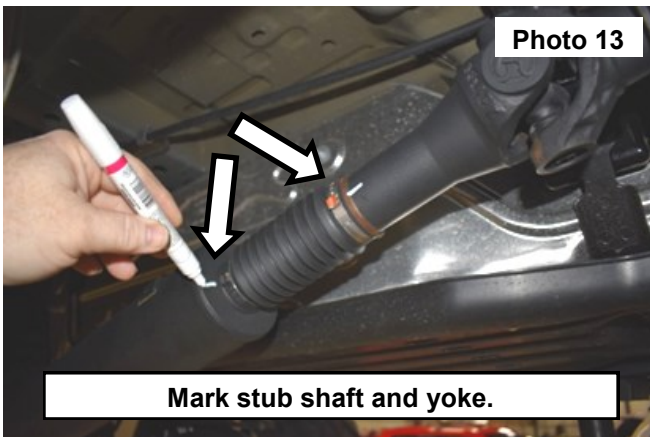

18. Use a jack stand for support and disconnect the rear flange from the rear pinion. Use a 15mm socket to remove. See Photo 16.

19. With the front clamp loose and the rear shaft supported, pull the rear stub shaft loose from the yoke shaft. Clock the

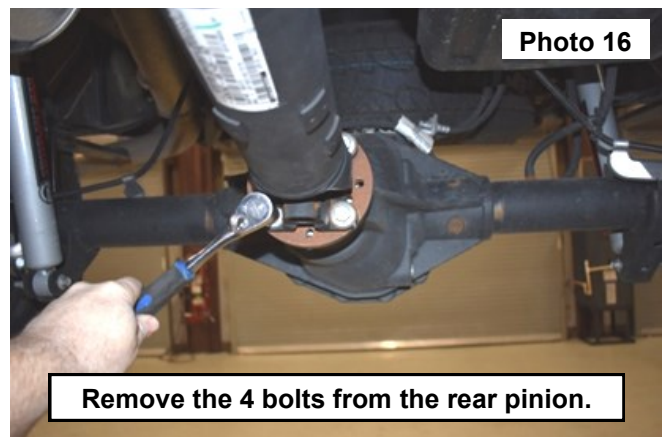
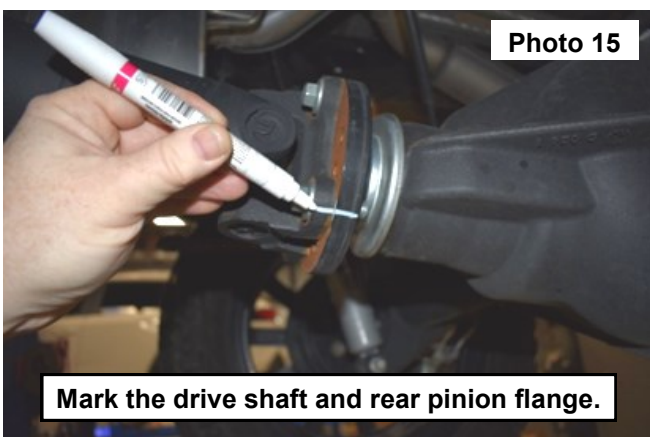

stub shaft 90 degrees and reassemble. The front end yoke at the transfer case and the rear end yoke at the pinion should now be aligned. If they are not aligned then repeat this step to acquire alignment. See Photos 17 and 18.

20. Using a band clamp tool, re-clamp the drive shaft band that was loosened. See Photo 19.

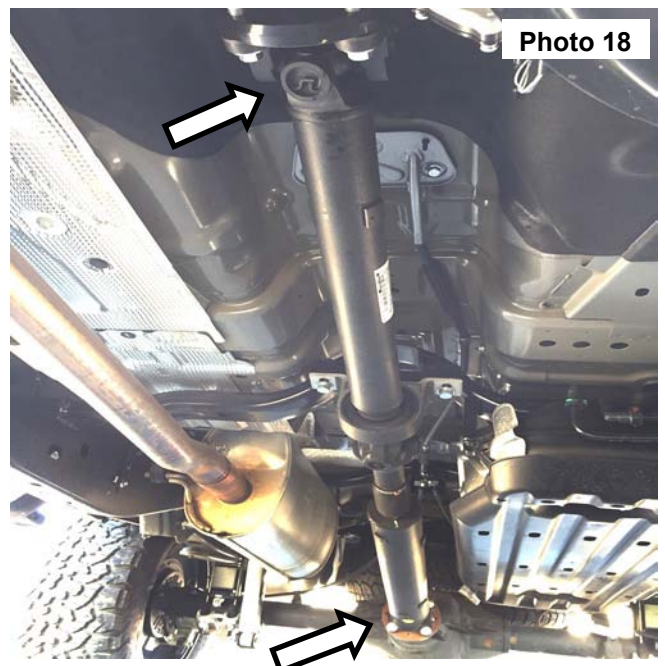
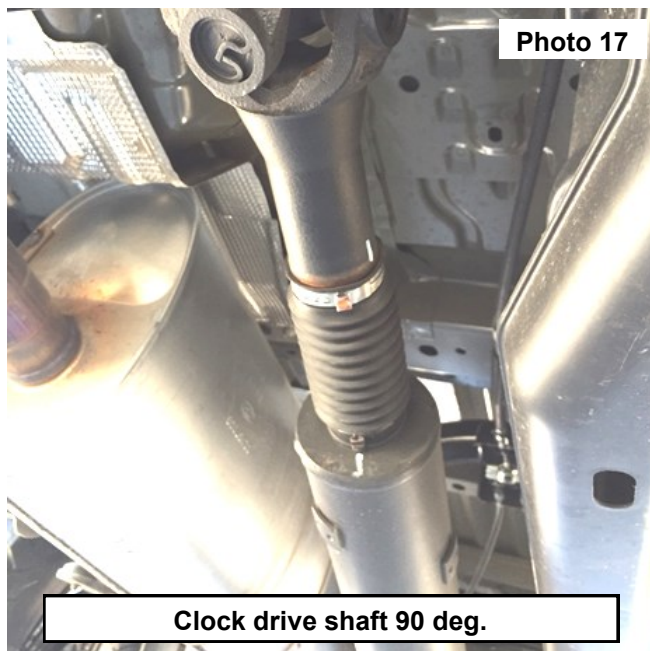

21. Reattach the drive shaft flange to the rear pinion using the 4 retained bolts. Make sure to align the previous marks. Use a 15mm socket. **See Photo 20.**
22. Install the wheels and tires onto the vehicle and tighten using a 19mm socket.

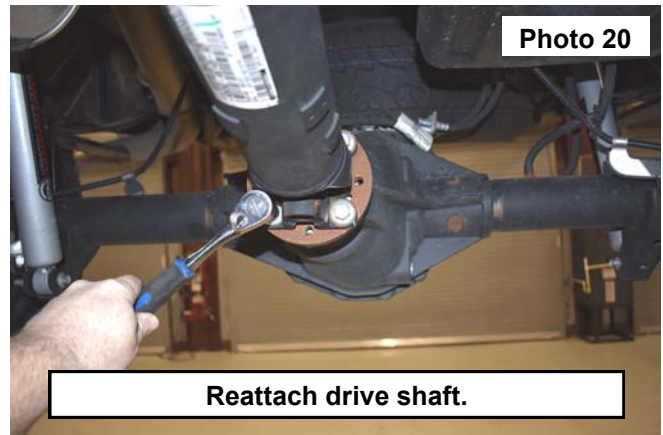
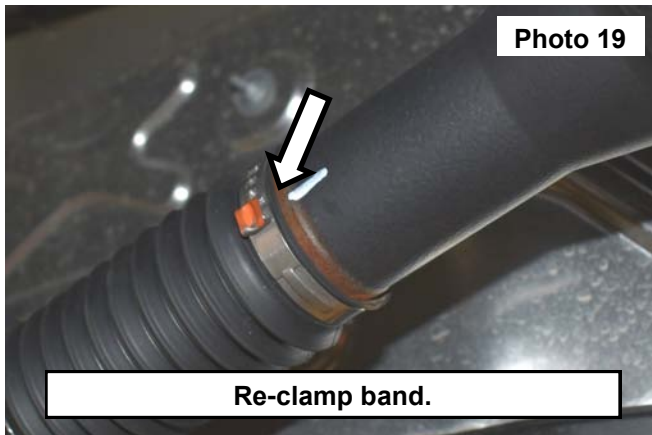

23. Using a jack, raise up the rear of the vehicle and remove the jack stands to lower the vehicle to the ground.
24. Remove the rear wheel chocks.
25. The front end of this vehicle will require an alignment.



By purchasing any item sold by Rough Country, LLC, the buyer expressly warrants that he/she is in compliance with all applicable , State, and Local laws and regulations regarding the purchase, ownership, and use of the item. It shall be the buyers responsibility to comply with all Federal, State and Local laws governing the sales of any items listed, illustrated or sold. The buyer expressly agrees to indemnify and hold harmless Rough Country, LLC for all claims resulting directly or indirectly from the purchase, ownership, or use of the items.





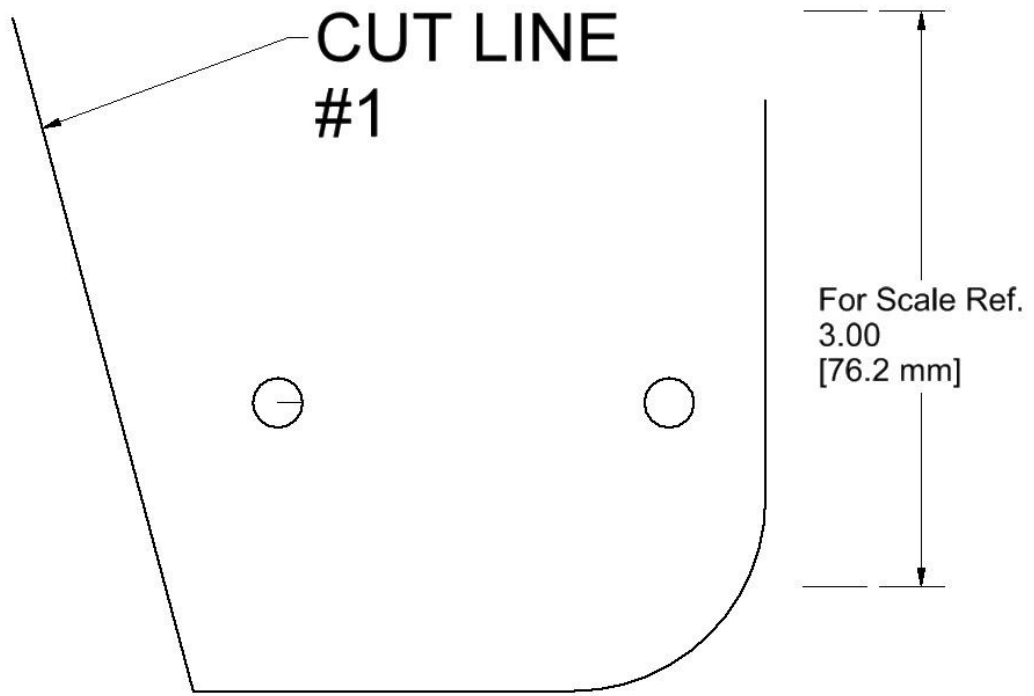



Mark at arrows when template is on the vehicle.

