

921221200H

ROUGH COUNTRY

SUSPENSION SYSTEMS®



1221BAG18

2015-20 Colorado/ Canyon 4" and 6" 2wd/4wd Lift Kit

Thank you for choosing Rough Country for all of your suspension needs.

Rough Country recommends a certified technician installs this system. In addition to these instructions, professional knowledge of disassemble/reassembly procedures as well as post installation checks must be known. Attempts to install this system without this knowledge and expertise may jeopardize the integrity and/or operating safety of the vehicle.

Please read all the instructions before beginning the installation. Check the kit hardware against the Kit Contents list on next page. Be sure you have all the needed parts and understand where they go. Also please review the tools needed list to be certain that you have the tools necessary to complete the installation.

PRODUCT USE INFORMATION

▲ WARNING As a general rule, the taller a vehicle is the easier it will roll. We strongly recommend, because of rollover possibility, that seat belts and shoulder harnesses should be worn at all times. Avoid situations where a side rollover may occur. Braking performance and capabilities are decreased when significantly larger/heavier tires and wheels are used. Take this into consideration while driving. Also, speedometer recalibration is necessary when larger tires are installed.

Do not add, alter, or fabricate any factory or after-market parts which increase vehicle height over the intended height of the Rough Country product purchased. Mixing component brands, lifts, with this suspension lifts voids all warranties. Rough Country makes no claims regarding lifting devices and excludes any and all implied claims. We will not be responsible for any product that is altered.

▲ NOTICE Due to differences in manufacturing, dimension and inflated measurements, tire and wheel combinations should be test fit prior to installation. A quality tire of radial design is recommended. **Factory wheels will not fit.**

For the **4"** lift application we recommend an 18" wheel not to exceed 9" in width with **5" of backspacing/ 0 offset** and a **275/65-18** tire.

For the **6"** lift application we recommend an 18" wheel not to exceed 9" in width with **5" of backspacing/ 0 offset** and a **285/65-18** tire.

▲ NOTICE NOTICE TO DEALER AND VEHICLE OWNER

Any vehicle equipped with any Rough country product must have the "Warning to Driver" decal installed on the sun visor or dash. The decal is to act as a constant reminder for whoever is operating the vehicle of its unique handling characteristics. **INSTALLING DEALER**—It is your responsibility to install the warning decal and to forward these installation instructions on too the vehicle owner for review and to be kept in the vehicle for its service life.

We hope installing your Rough Country lift kit is a positive experience. Please note that variations in construction and assembly in the vehicle manufacturing process will virtually ensure that some parts may seem difficult to install. Additionally, the current trend in manufacturing of vehicles results in a frame that is highly flexible and may shift slightly on disassembly prior to installation. The use of pry bars and tapered punches for alignment is considered normal and usually does not indicate a faulty product. However, if you are uncertain about some aspect of the installation process, please feel free to call our tech support department at 800-222-7023. We do not recommend that you modify the Rough Country parts in any way as this will void any warranty expressed or implied.



KIT CONTENTS

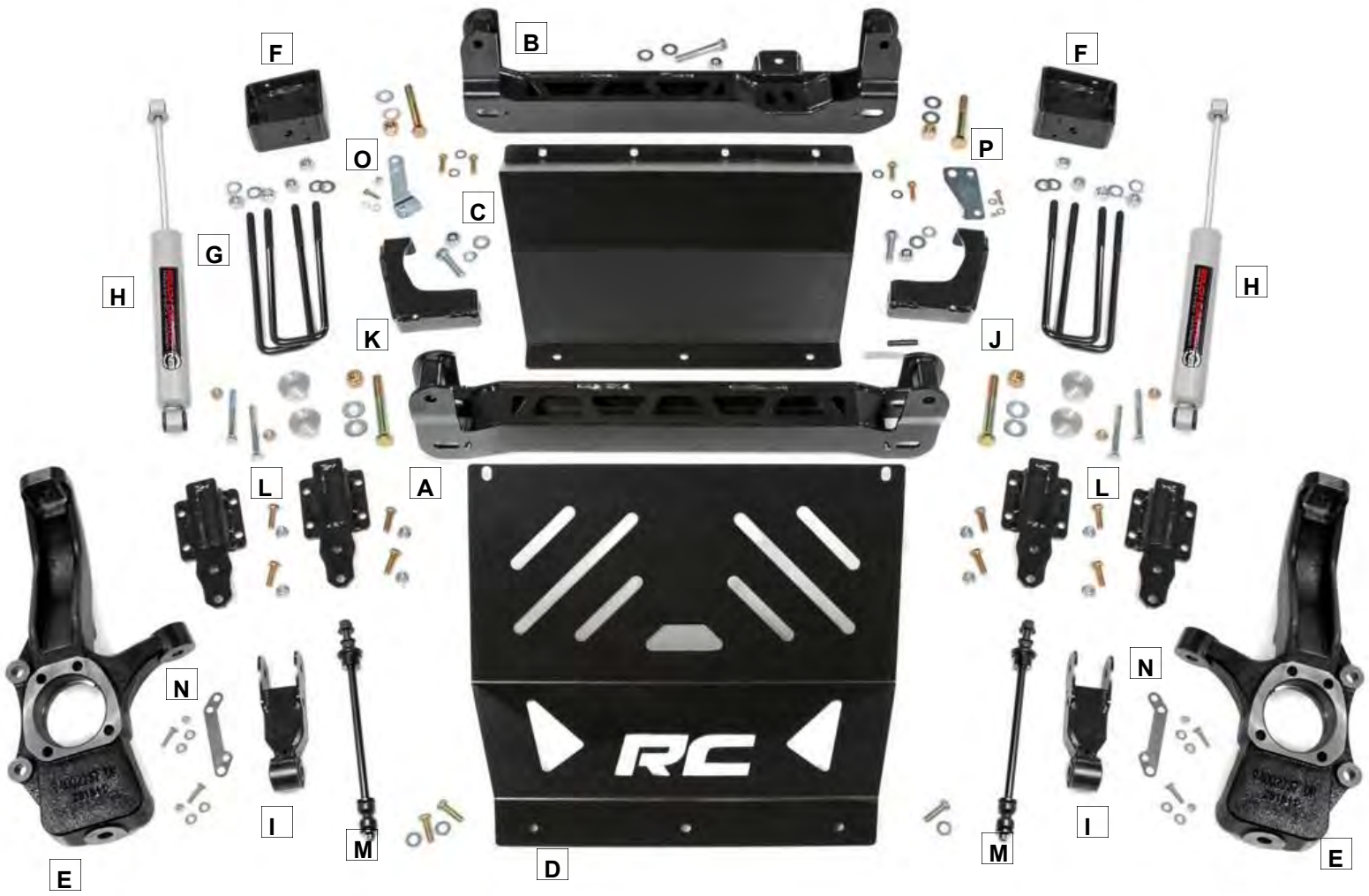

6" KIT PICTURED

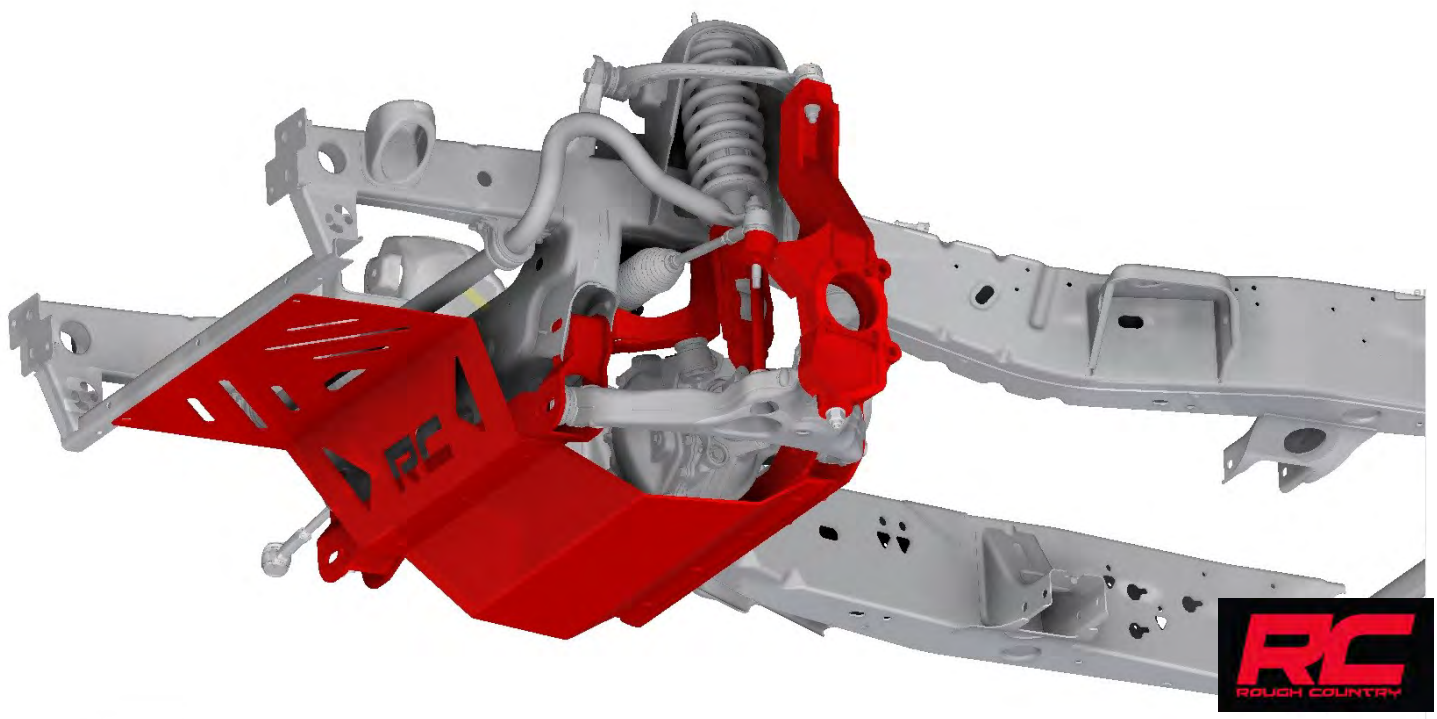

Kit Contents:

1241Box5:

- Front Crossmember (A)
- Rear Crossmember (B)
- 1221BAG1

1221Box2:

- Lower Skid Plate (C)
- 1221BAG5

1221Box3:

- Front Skid Plate (D)

1221Box4:

- Dr & Pass. Knuckles (E)

1221Box5: (4in Lift Box)

- 2.5in Blocks (2) (F)
- U-bolts (4) (G)
- Rear Shocks (2) (H)
- Strut Extensions (2) (I)
- 1221BAG4
- Strut Bushings (4)
- Sleeves (4)

Or 1241Box6: (6in Lift Box)

- 4.5in Blocks (2)
- U-bolts (4)
- Rear Shocks (2)
- Strut Extensions (2)
- 1221BAG4
- Strut Bushings (2)
- Sleeves (4)

1241Box9 (6" Kit):

- Driver Differential Bracket (J)
- Pass Differential Bracket (K)
- Sway Bar Links (2) (M)
- Front Brake Line Relocation (2) (N)
- Rear Brake Line Relocation (O)
- Rear E-Brake Relocation (P)
- 1221BAG13
- 1221BAG18
- 1241BAG2

1221Box8 (4" Kit):

- Strut Clamps (L)
- Driver Differential Bracket (J)
- Pass Differential Bracket (K)
- Sway Bar Links (2) (M)
- Front Brake Line Relocation (2) (N)
- Rear Brake Line Relocation (O)
- Rear E-Brake Relocation (P)
- 1221BAG13
- 1221BAG18
- 1241BAG2

23035 (2)- 6" N3 Strut Kit Only

Box below is in place of 1241BOX6 for the N3 strut kit:

1241Box8(Struts): (6in Lift Box)

- 4.5in Blocks (2)
- U-bolts (4)
- Rear Shocks (2)

Fastener Breakdown:

For Front Cross Member: 1221Bag1

- 5/8" x 4.5" Bolt (2)
- 5/8" Nylock Nut (2)
- Flat Washer (4)

For Rear Cross Member:

- 5/8" x 4" Bolt (2)
- 5/8" Nylock Nut (2)
- Flat Washer (4)

For Pass Side Dif Drop Brkt: 1221BAG13

- 14mm Lock Nut (1)
- 14mm x 50mm Bolt (1)
- 9/16" Flat Washer (1)
- 9/16" Lock Washer (1)

For Driver Side Dif Drop Brkt.

- 14mm Lock Nut (1)
- 14mm x 50mm Bolt (1)
- 9/16" Flat Washer (1)
- 9/16" Lock Washer (1)

For Rear Differential Mount: 1221Bag1

- 14mm x 90mm Bolt (1)
- 9/16" Flat Washer (2)
- 14mm Nylock Nut (1)

For Strut Extension: 1221Bag4

- 3/8" x 1 1/4" Bolt (8)
- 3/8" Flange Lock Nut (8)

For Strut Clamp: 1221Bag4

- 7/16" x 3 1/4" Bolt (4)
- 7/16" Top Lock Nut (4)

For ABS Line on Knuckle: 1221BAG13

- 1/4" x 1" Bolt (2)
- 1/4" Flat Washer (4)
- 1/4" Nylock Nut (2)

For Skid Plates: 1221Bag5

- 3/8" x 1 1/4" Bolt (7)
- 3/8" Flat Washer (7)

For Front Brake Line Brkt: 1221BAG13

- 1/4" x 1" Bolt (4)
- 1/4" Nylock Nut (4)
- 1/4" Flat Washers (8)

For Rear Brake Line Brkt: 1221BAG13

- 5/16" x 1" Bolt (1)
- 5/16" Flat Washer (1)
- 5/16" Flange Lock Nut (1)

For Rear E-Brake Bracket: 1221BAG13

- 5/16" x 1" Bolt (1)
- 5/16" Flat Washer (1)
- 5/16" Flange Lock Nut (1)

For Rear Shocks: 1221Bag4

- Shock Sleeves (4)

Rear U-bolts: 9/16Bag

- 9/16" Nylock Nuts (8)
- 9/16" Flat Washers (8)

For Rear Differential Mount: 1221Bag13

- 14MM x 110MM Bolt(1)
- Rear Diff Shims (2)

For Driveshaft Spacer: 1241Bag2

- 10MM x 70MM Bolts(6)
- Driveshaft Spacer(1)

Torque Specs:

Size	Grade 5	Grade 8	Size	Class 8.8	Class 10.9
5/16"	15 ft/lbs	20ft/lbs	6MM	5ft/lbs	9ft/lbs
3/8"	30 ft/lbs	35ft/lbs	8MM	18ft/lbs	23ft/lbs
7/16"	45 ft/lbs	60ft/lbs	10MM	32ft/lbs	45ft/lbs
1/2"	65 ft/lbs	90ft/lbs	12MM	55ft/lbs	75ft/lbs
9/16"	95 ft/lbs	130ft/lbs	14MM	85ft/lbs	120ft/lbs
5/8"	135ft/lbs	175ft/lbs	16MM	130ft/lbs	165ft/lbs
3/4"	185ft/lbs	280ft/lbs	18MM	170ft/lbs	240ft/lbs

TOOLS NEEDED:

- 6mm Allen
- 10mm socket /wrench
- 13mm socket /wrench
- 15mm socket / wrench
- 16mm wrench
- 17mm socket / wrench
- 18mm socket /wrench
- 21mm socket /wrench
- 24mm socket /wrench
- 35mm socket
- T30
- Torque Wrench
- 7/16 socket/wrench
- 1/2 socket/ wrench
- 5/8 socket/ wrench
- 9/16 socket /wrench
- 11/16 socket/ wrench
- 13/16 socket/ wrench
- 15/16 socket/ wrench
- Loc-Tite
- Reciprocating Saw
- Floor Jack
- Jack Stands
- Pliers



INSTALLATION INSTRUCTIONS

1. Chock the rear wheels.
2. Jack up the front of the vehicle.
3. Place jack stands on the frame behind the lower control arms.
4. Lower the vehicle onto the jack stands and remove the tires and wheels.
5. Place the floor jack under the differential.
6. Using a 15mm socket remove the factory skid plate. Retain factory hardware. **See Photo 1.**
7. Using 15mm socket, remove the differential skid. **See Photo 2.**

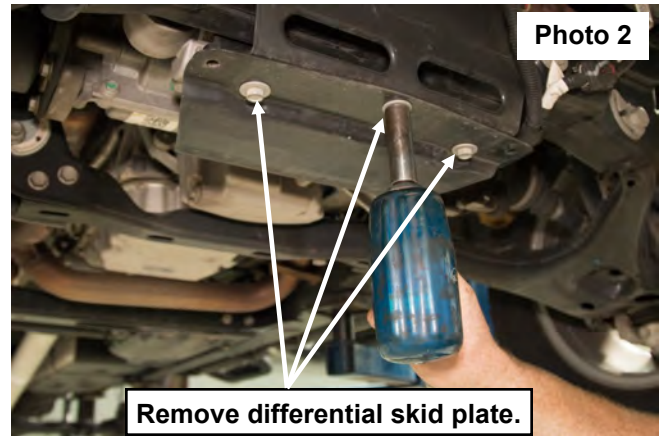
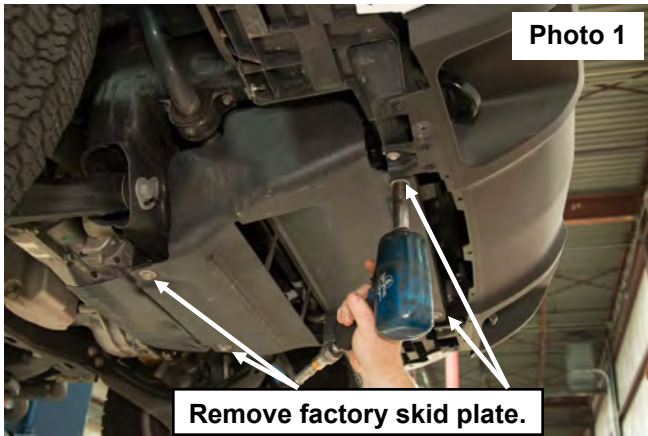

8. Unplug the connectors going to the electric power steering. **See Photo 3.**
9. Remove tie-rod using a 21mm socket / wrench. Using a hammer strike the knuckle to break the taper loose. Retain the stock hardware. **See Photo 4.** You may have to hold the TRE with a 10mm wrench when loosening.

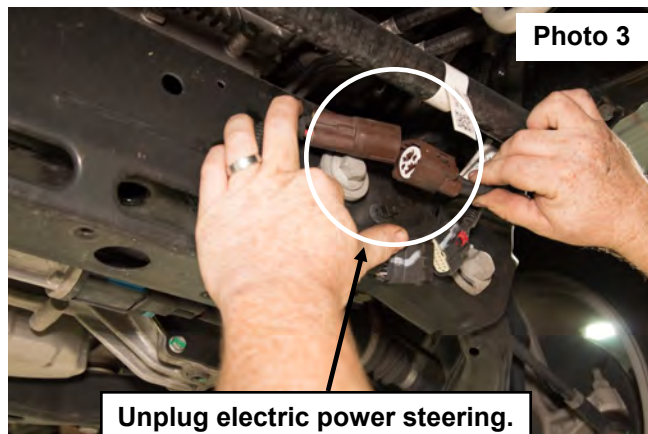

10. Using a 18mm socket remove the brake caliper from the factory knuckle. **Do Not allow caliper to hang from brake line.** Retain the factory hardware. **See Photo 5.**
11. Using a T30 remove the brake rotor from the hub assembly. **See photo 6.**

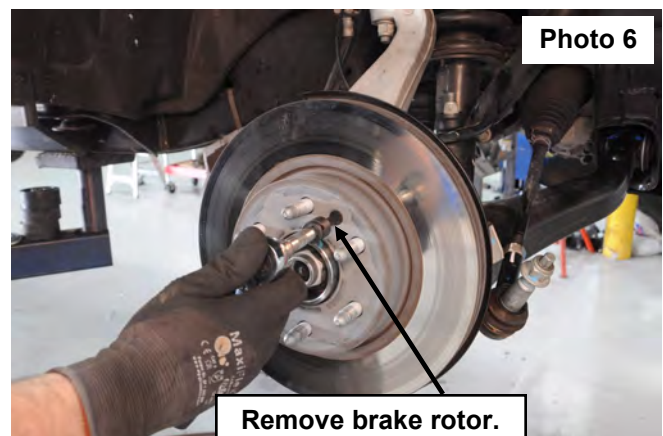

12. 2wd models skip to step 13. Using a 35mm socket, remove the axle nut and washer. **Photo 7**

13. Using a T30, remove the ABS sensor from the knuckle. **Photo 8.**

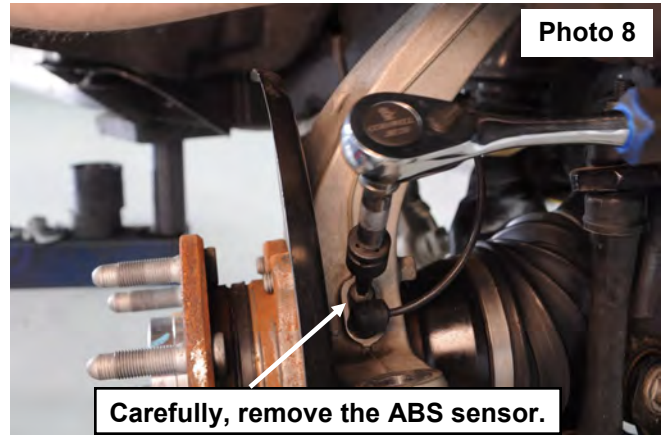
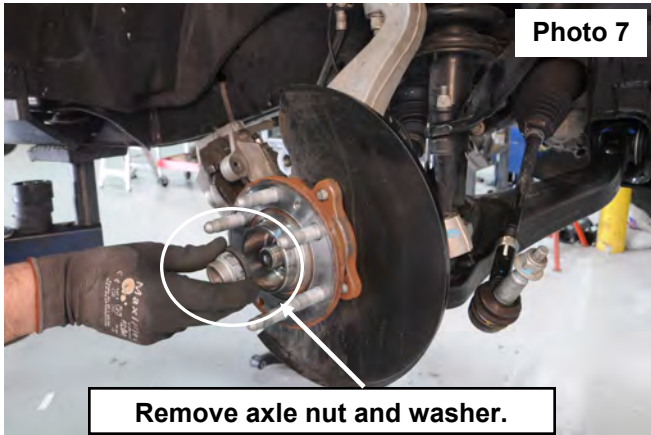

14. Using a 10mm socket, remove the ABS line from the back of the knuckle. **See Photo 9.**

15. Using a 18mm wrench, loosen the upper ball joint nut, **Do Not remove at this time.** Strike the knuckle with a hammer to break the taper loose. **See Photo 10.** You may need to use a 6mm Allen to hold the ball joint.

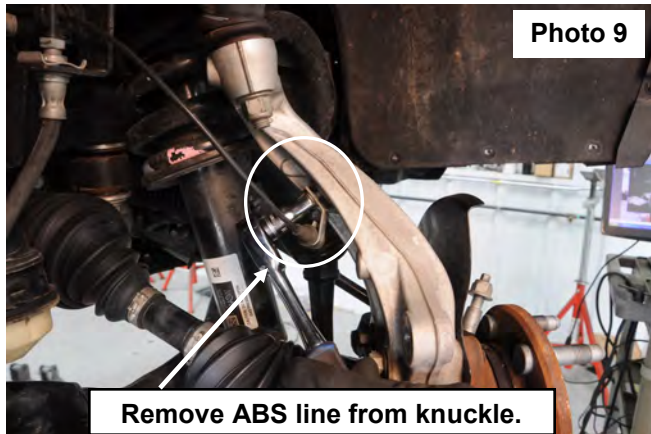

16. Using a 24mm wrench, loosen the lower ball joint nut, **Do Not remove at this time.** Strike the knuckle with a hammer to break the taper loose. Remove the upper and lower ball joint nuts and remove the knuckle. **See Photo 11.**

17. Using a 13mm socket and 15mm wrench, remove sway bar links. Retain bushings for reuse. **See Photo 12.** Sway bar may need to be removed to allow easier removal of the strut.

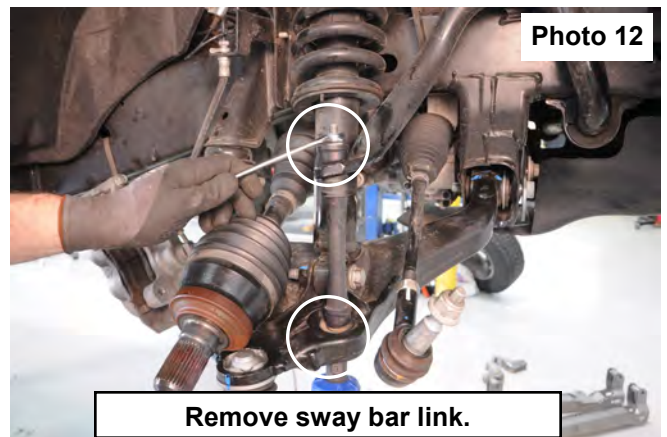

18. Using a 21mm socket, remove the lower strut bolt. Retain for reuse. **See Photo 13.**
19. Using 18mm wrench, remove the upper strut nuts. Retain for reuse. Remove the strut from the vehicle. **See Photo 14.**



Photo 13

Remove lower strut bolt from lower control arm.



Photo 14

Remove strut.

20. Using 24mm wrenches, remove the lower control arm bolts and cam washers. Retain for reuse. **See Photo 15.**
21. Remove lower control arm from vehicle. **See Photo 16.**

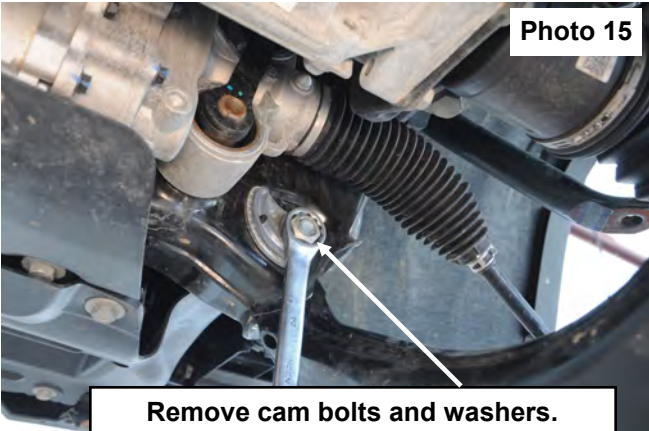

Photo 15

Remove cam bolts and washers.

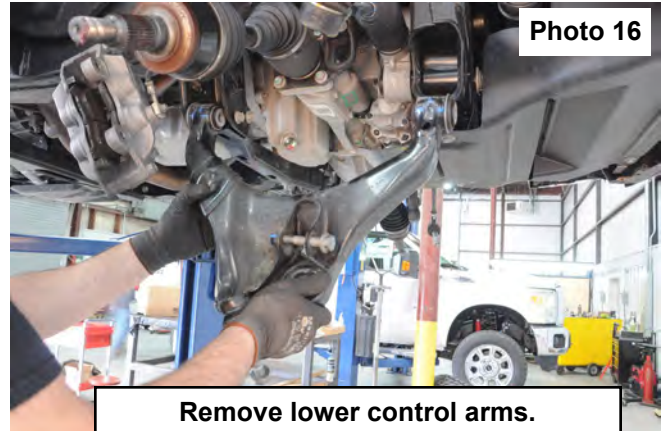

Photo 16

Remove lower control arms.

22. **2wd models skip to step 23.** Using a 21mm socket and 21mm wrench, remove driver differential bracket bolt from rear cross member. **See Photo 17.**
23. Remove the 4 bolts (2 each side) securing the cross-member using a 18mm socket and wrench. **See Photo 18.**

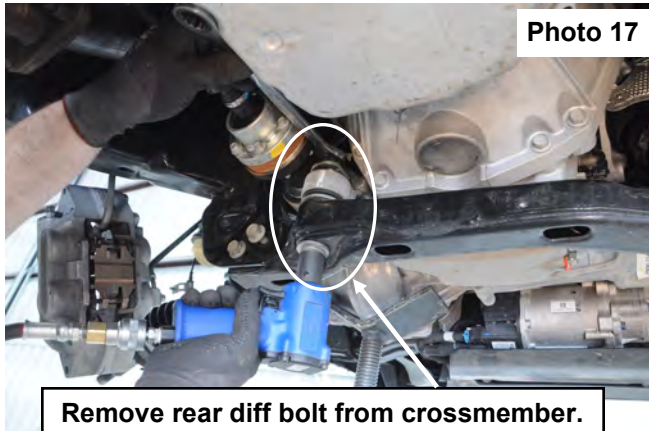

Photo 17

Remove rear diff bolt from crossmember.

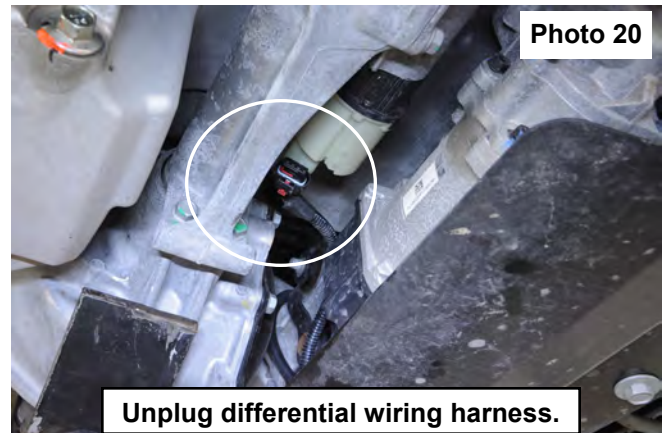
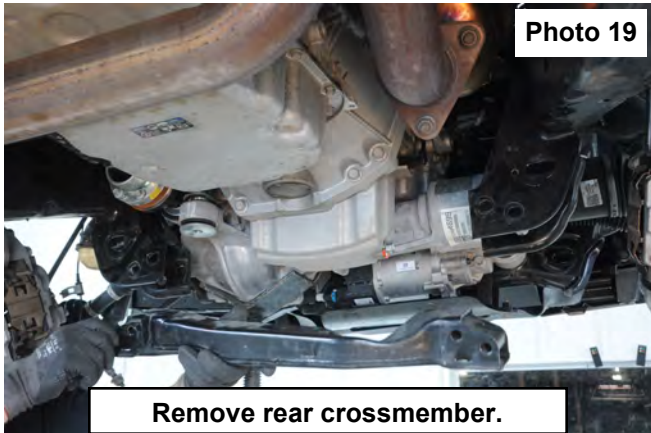

Photo 18

Remove rear crossmember bolts (4).

24. Remove the rear cross member from the vehicle. **See Photo 19.**

25. **2wd models skip to step 30.** Remove the differential wiring harness from the axle and vent tube. **See Photo 20.**



27. Using a 10mm wrench remove the front driveshaft from the differential. **See Photo 21.**

28. Support the differential using jack stands.

29. Using 21mm socket, remove the differential mounting bolts. Retain for reuse. While lowering the differential, remove the vent tube from the top. Place the differential out of the way for next step. **See Photos 22 and 23.**

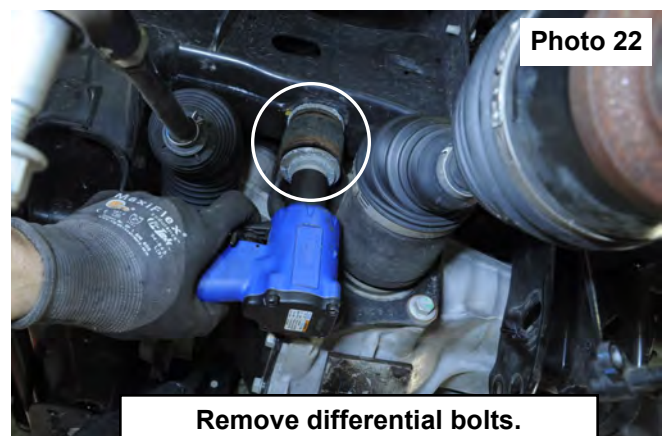
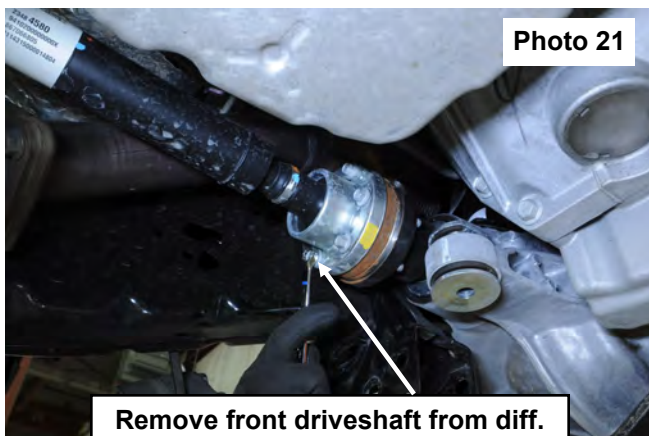

30. Measure 1" down from the lower control arm alignment adjustment slot and mark. Repeat this process on both sides of the front control arm pockets. **See Photo 24.**

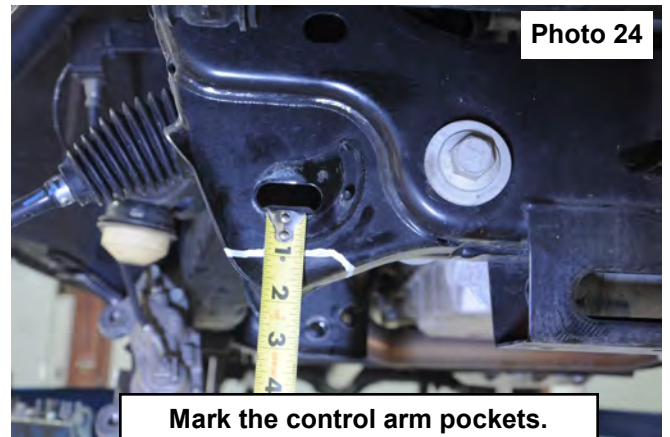
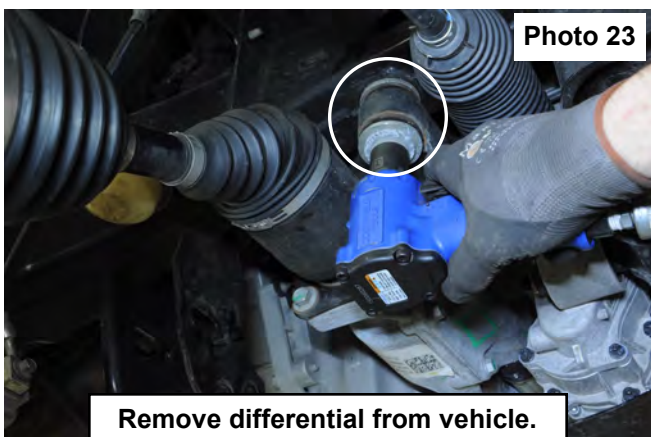

31. Connect measurement marks from both sides of the control arm pocket as shown in **Photo 25**. Trim this line using a reciprocating saw.
32. Place supplied templates on both sides of rear driver cross member mounts. Cut along line shown in **Photo 26**. Grind sharp edges and paint to prevent rust.

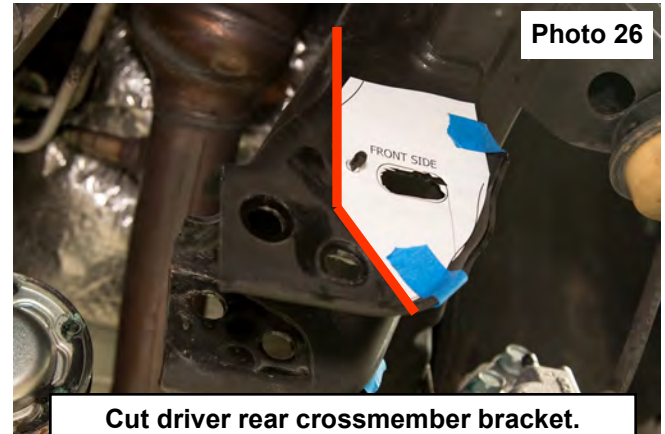
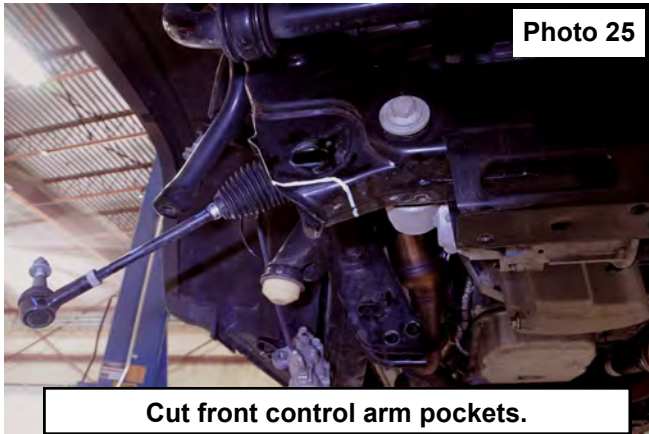

33. **2wd models skip to step 35.** Install the dr. and passenger differential drop brackets (1241BOX9) using the 14mm x 50mm supplied bolts, lock washers and flat washers from 1221BAG13 (1241BOX9), retain remaining hardware for use in step 38. **See Photo 27.** Torque to 88 ft-lbs. using a 22mm wrench.
34. Extend the differential vent tube with coupler and hose from 1221BAG13 (1241BOX9). **See Photo 28.**

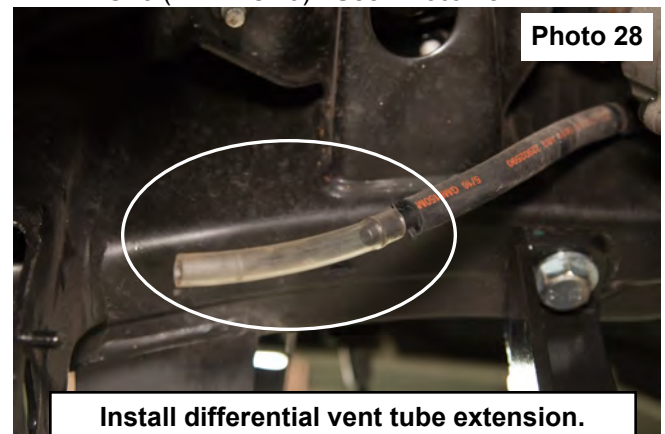
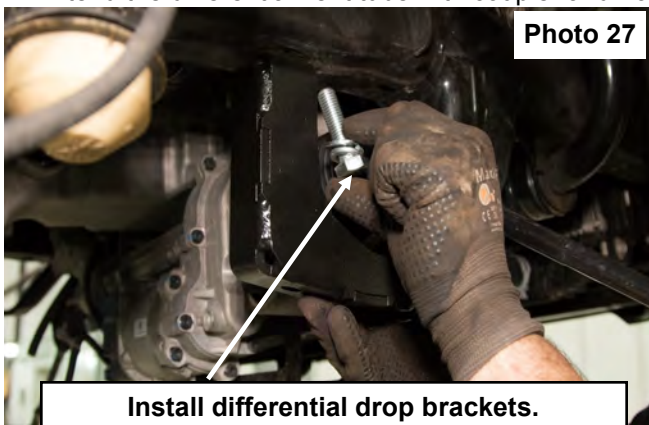

35. Install front cross member (1221BOX1) using supplied 5/8" x 4.5" bolts and hardware from 1221BAG1(1221BOX1). Front cross member mounting bolts will also attach differential drop brackets to the cross member. **Do not tighten at this time.**
36. **2wd models skip to step 38.** Attach differential to differential drop brackets using factory bolts and washers and 14mm nylock nuts from 1221BAG13 (1241BOX9). Retain remaining hardware for use in Step 63. **Do not tighten at this time.**
37. Reattach the differential wires and vent tube to the axle. It may be necessary to pull some slack from top. Do Not pull on the wiring connector as damage to the wires can occur. It may be necessary to unclip the differential wiring harness for slack. **See Photo 29.**
38. Install the rear cross member (1221BOX1) using the 5/8" x 4" bolts and hardware from 1221BAG1 (1221BOX1). **Do not tighten at this time. 2wd models skip to step 40.**
39. Attach differential to the rear cross member using the supplied 14mm x 110mm bolt, nut and washers in 1221BAG13 (1241BOX9). Place **1 shim** from 1221BAG13 (1241BOX9) between the crossmember and the differential. **See Photo 30. Due to manufacturing variances, we have supplied 2 differential shims. If driveline vibration is experienced, you may need add the 2nd shim.** Torque to 120 ft-lbs. using a 22mm socket.

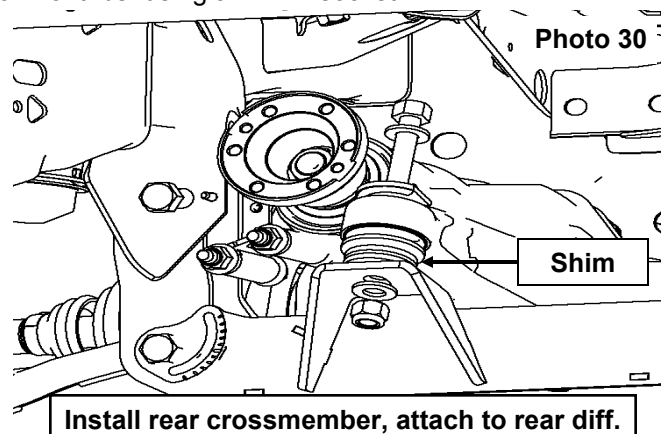
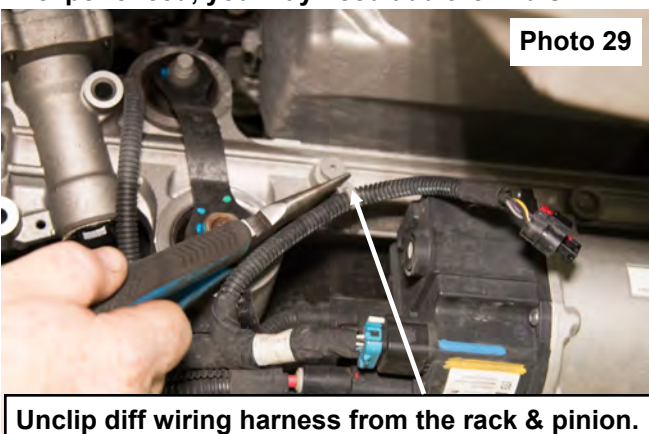

40. Reinstall the lower control arm with stock hardware. **See Photo 31. Do not tighten at this time.**
 41. **2wd models skip to step 42.** Using 21mm socket, Torque the differential mounting bolts to 120 ft-lbs. **See Photo 32.**

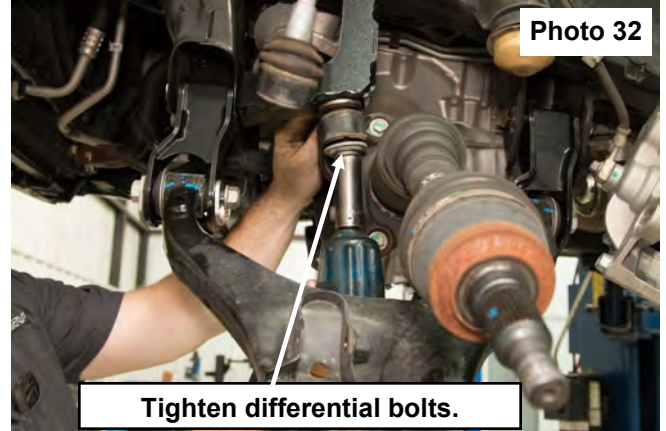
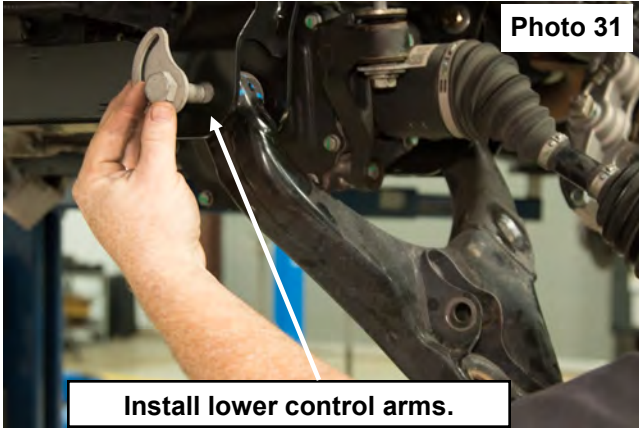

42. Using 15/16" socket and wrench Torque the front and rear cross member mounting bolts to 185ft-lbs. **See Photo 33.**
 43. **2wd models skip to step 44.** Using a reciprocating saw, cut the corner off of the exhaust flange to clear the driveshaft.. **See Photo 34.**

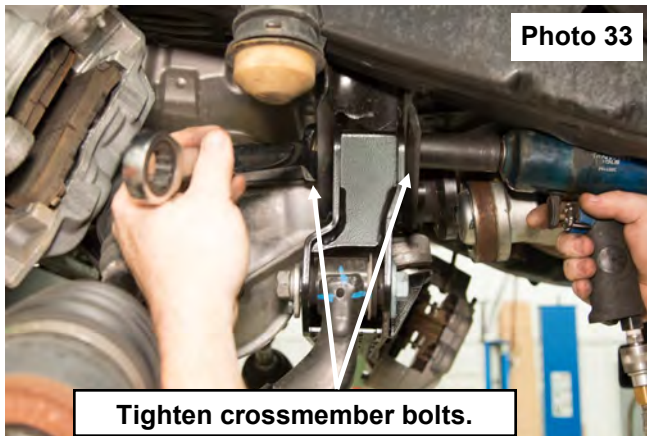

▲ NOTICE If installing lifted struts, refer to instructions included with struts and skip to step 50.

44. Press the stock bushings out of the struts. **See Photo 35.**
 45. Install the supplied aluminum bushings, from 1221BAG4 (1221BOX5, 1233BOX1, or 1241BOX1), in the lower strut eyelet. **See Photo 36.**



46. Install the strut clamp on the bottom of the strut using 3/8" x 1.25" bolts and hardware in 1221BAG4 (1221BOX5, 1233BOX1, or 1241BOX1) **See Photo 37.**
47. Slide the strut extension onto the bottom of the strut. **See Photo 38.**
48. Place (2) of the 7/16" x 3.25" bolts and top lock nuts from 1221BAG4 (1221BOX5, 1233BOX1, or 1241BOX1) through the lower mounts of the strut and strut clamp. Torque to 70 ft-lbs. using 5/8" socket and 11/16" wrench. **See Photo 38. Make sure nut will be facing away from CV boot when installed on the truck.**



Photo 37

Install strut clamp.

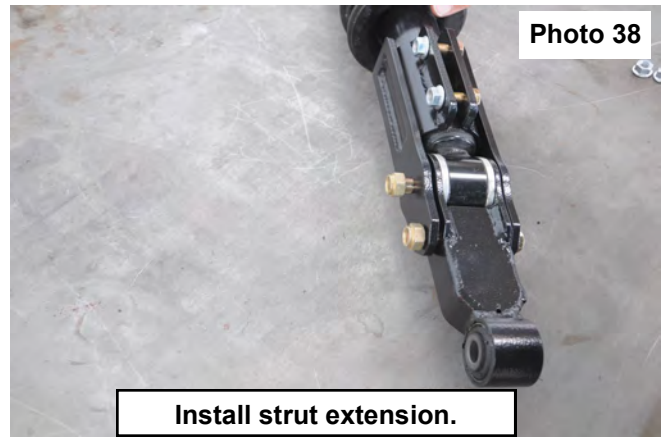

Photo 38

Install strut extension.

49. Tighten the 3/8" clamp bolts using 9/16" socket and wrench. **See Photo 39.**

▲ NOTICE Torque to 15-17ft-lbs in a X pattern.

50. Lay the factory knuckle hub side down. **See Photo 40.**

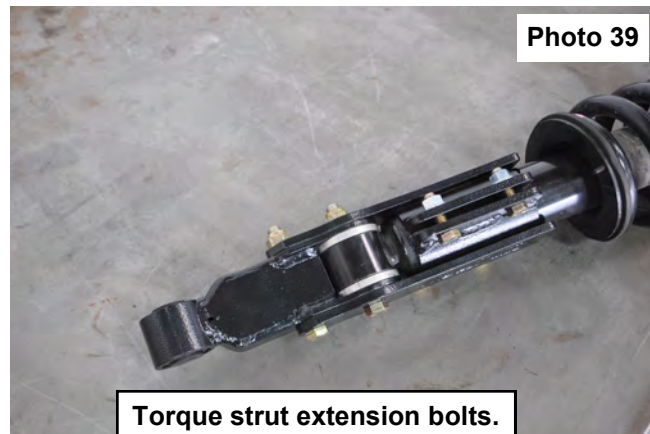

Photo 39

Torque strut extension bolts.

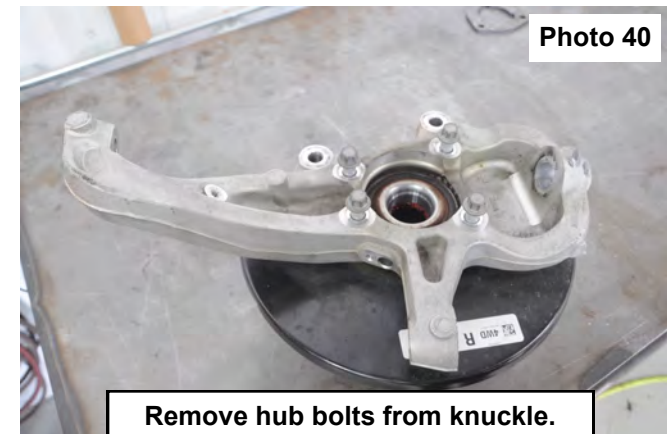

Photo 40

Remove hub bolts from knuckle.

51. Using a 13mm socket remove the 4 hub bolts from the factory knuckle. **See Photo 41**

52. Place new lift knuckle on hub bearing and Torque the hub bolts to 78 ft-lbs. using a 13mm socket. **See Photo 42.**



Photo 41

Remove hub from stock knuckle.



Photo 42

Install stock hub in lifted knuckle.

53. Install strut assembly onto vehicle using factory hardware. Torque the upper nuts to 35 ft-lbs. with a 18mm socket. **See Photo 43. Do not tighten lower strut bolt at this time.**
55. Install the lifted knuckle, install the axle into the hub and the knuckle on the lower ball joint using stock hardware, Torque the lower ball joint nut to 110 ft-lbs. Install the upper ball joint into the knuckle using stock hardware Torque the upper ball joint nut to 85 ft-lbs. **See Photo 44.**



56. **2wd models skip to step 57.** Reinstall the factory axle nut and washer and Torque to 155 ft-lbs. using a 35mm socket. **See Photo 45.**
57. Install ABS sensor in the knuckle and Torque to 15 ft-lbs. using T30. **See Photo 46.**

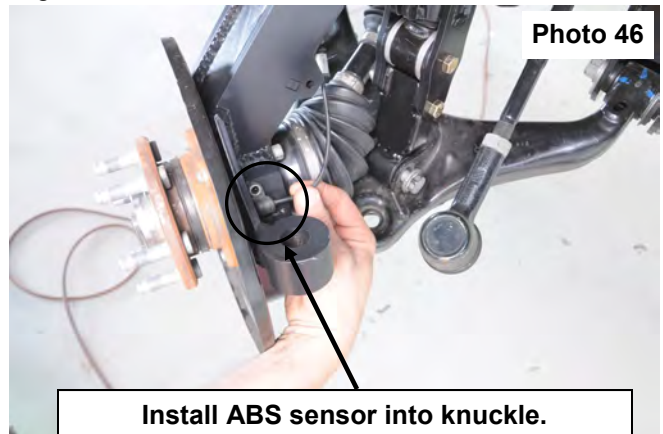

58. Measure 1" from the edge of the bottom of the dust shield. **See Photo 47.**
59. Mark a line as shown in **Photo 48** and cut dust shield with a reciprocating saw. Grind sharp edges and paint to prevent rusting.
60. Install brake rotor and Torque to 5ft-lbs. tighten using a T30.



60. Install brake caliper onto knuckle using factory hardware. Torque to 126 ft-lbs. using a 18mm socket. **See Photo 49.**
61. Attach ABS wire to the knuckle using supplied 1/4" x 1" bolts and hardware from 1221BAG13 (1241BOX9). **See Photo 50.** Torque to 5 ft-lbs.

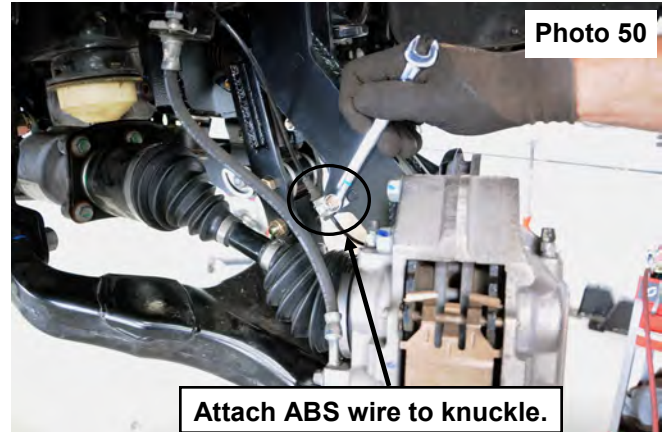
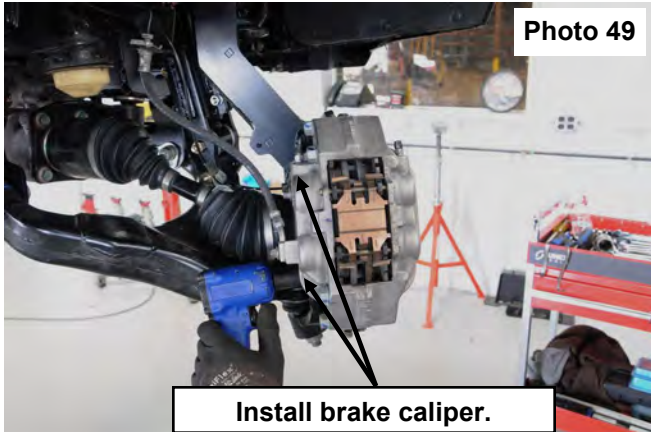

62. Install the front brake line relocation bracket using the 1/4" x 1" bolt and hardware from 1221BAG13 (1241BOX9). Torque to 5 ft-lbs. using 7/16" wrenches. **See Photo 51.**

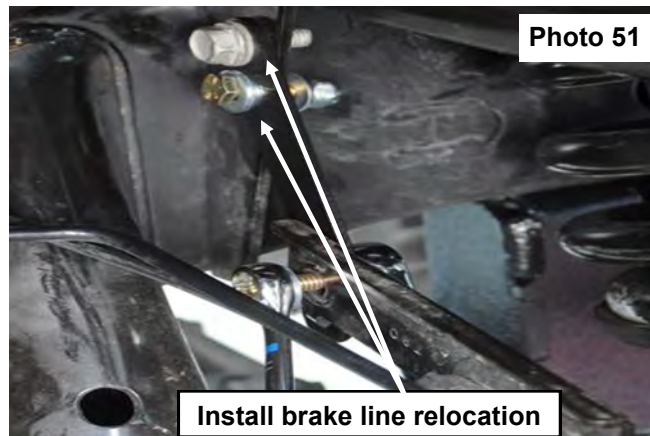

63. Install the new sway bar links, ball stud end up, using supplied hardware. Torque 85 ft-lbs. the top using a 21mm socket and a 9/16" wrench to keep from spinning. Torque 25 ft-lbs. the bottom using a 15mm socket and a 13mm wrench to keep from spinning. **See Photos 52 & 53.**

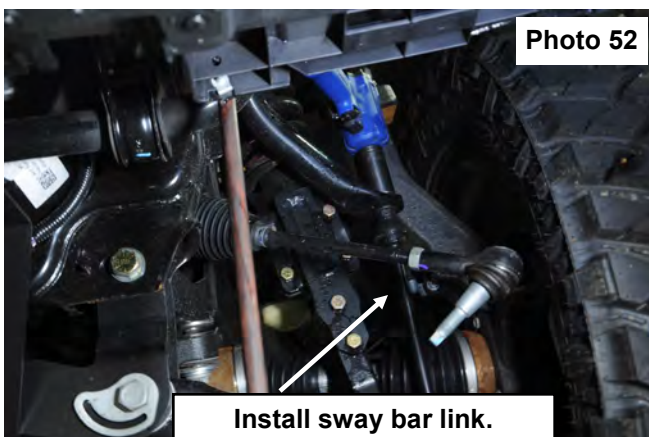

64. Reinstall the tie rod and Torque to 55 ft-lbs. using a 21mm wrench. **See Photo 54.**

65. **2wd models skip to step 66.** Reattach the driveshaft to the differential using the stock hardware, Torque to 35 ft-lbs. using a 10mm wrench. **See Photo 55.**

▲ NOTICE *****Refer to last 2 pages for driveshaft spacer install instructions!*****
Check driveshaft to exhaust clearance. Crossover pipe may need rerouting and/or flange (in Photo 34) may need to be rotated. We recommend an exhaust professional perform this modification.

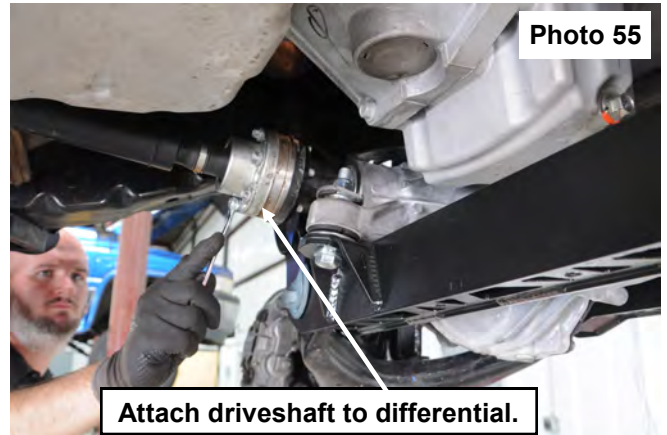
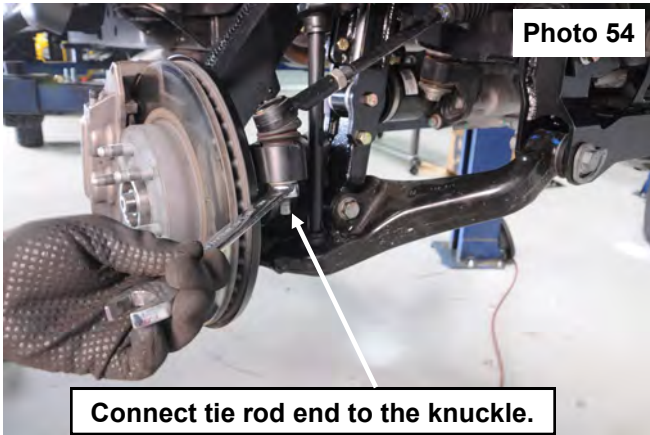

66. Reconnect electric rack and pinion wiring. **See Photo 56.**

67. Install upper and lower skid plates using the (7) 3/8" x 1.25" bolts and hardware from 1221BAG5 (1221BOX2). Attach the upper skid plate to the frame using factory hardware. Torque to 28 ft-lbs. using 9/16" and 15mm sockets. **See Photo 57.**

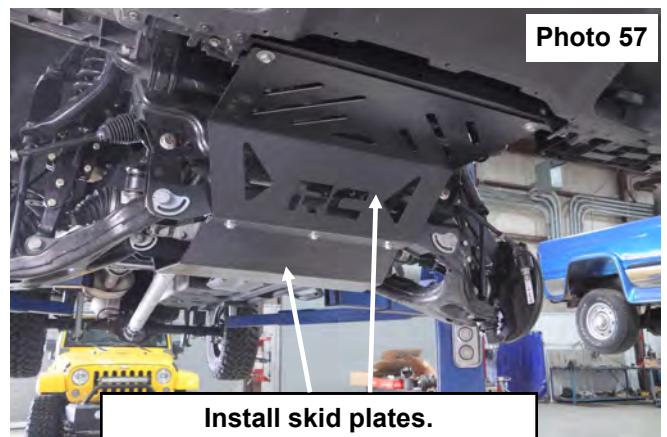

68. Install wheel and tires and lower the vehicle to the ground.

69. Torque the lower strut bolt to 125 ft-lbs. using a 21mm socket.

70. Torque the lower control arm adjusting bolts to 190 ft-lbs. using a 24mm wrench and socket. **See Photo 58.**

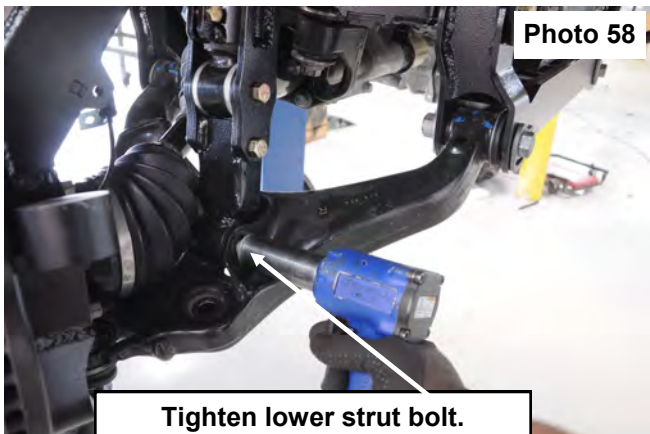

REAR INSTALLATION INSTRUCTIONS

1. Chock the front tires.
2. Position a floor jack under the rear differential and jack up the vehicle.
3. Place jack stands under the frame rails just forward of the front leaf spring hangers and lower the frame on the jack stands.
4. Reposition the floor jack under the center of the differential and apply slight pressure for support, but do not raise the frame off the jack stands.
5. Using a 13mm wrench, remove the E-brake and brake line brackets from the frame.
6. Remove the rear shock with a 21mm wrench on the upper and lower mount. Retain for later use. **See Photo 1.**

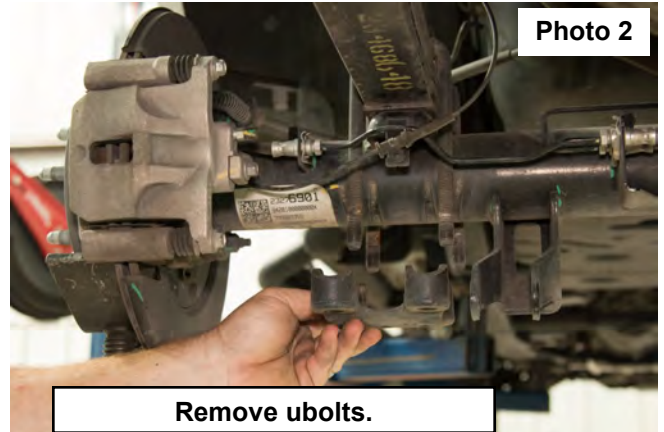
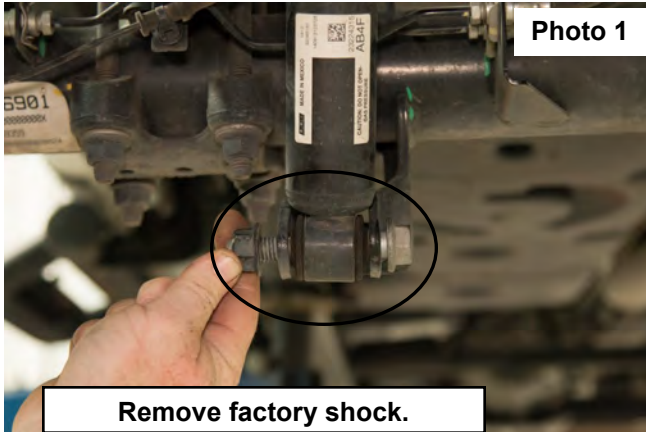

7. Using a 21mm remove the u-bolts and lower u-bolt plate. **See Photo 2.**
8. Place supplied lift block between the leaf spring and axle pad. **Thicker end of the block goes to the rear of the truck. See Photo 3.** The 4" kit utilizes a 2.5" block, the 5" kit a 3.5" block and the 6" kit a 4.5" rear block.

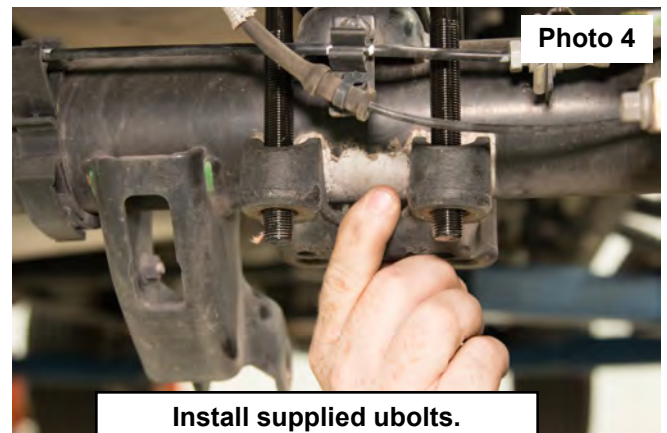
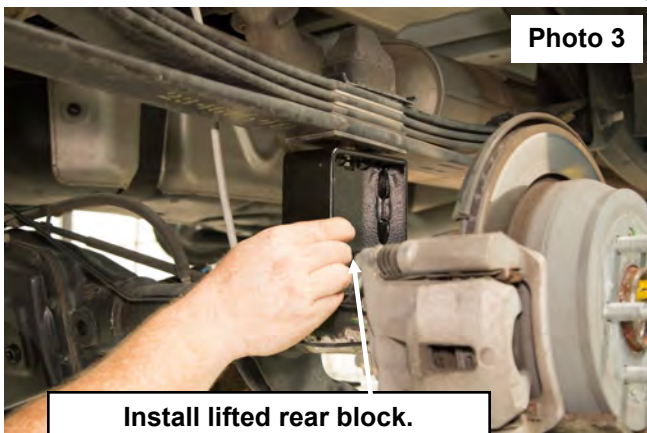

9. Install supplied u-bolts over the leaf spring. Use the factory lower u-bolt plate. **See Photo 4.**
10. Secure using the supplied hardware from 9/16BAG (1221BOX5, 1233BOX1, or 1241BOX1). Torque to 90 ft-lbs. using 13/16" socket. **See Photo 5.**
11. Attach the supplied rear brake line relocation bracket to the frame using the factory hardware. Torque to 15 ft-lbs. . Attach the factory brake line bracket to the relocation bracket using the 5/16" x 1" bolt and hardware from 1221BAG13 (1241BOX9). Torque to 15 ft-lbs. using 1/2" wrenches. **See Photo 6.**

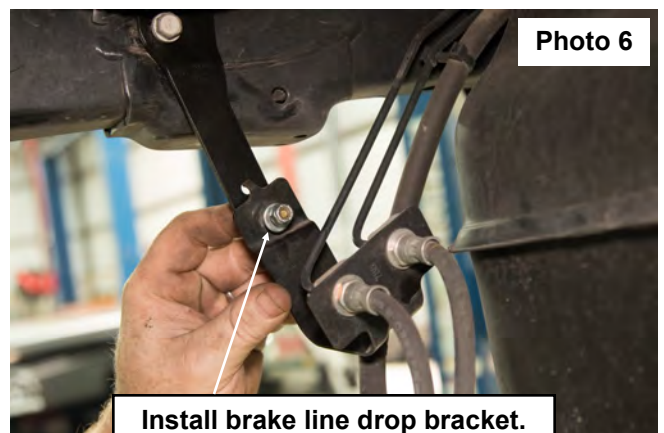
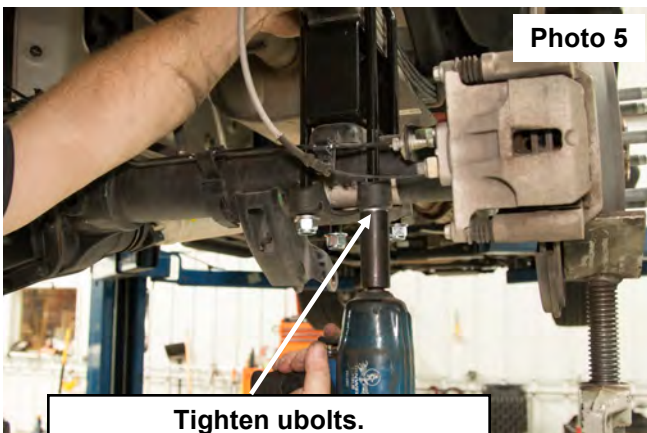

12. Attach the supplied rear E-brake relocation bracket to the frame using the factory hardware. Torque to 15 ft-lbs. . Attach the factory E-brake bracket to the relocation bracket using the 5/16" x 1" bolt and hardware from 1221BAG13 (1241BOX9). Torque to 15 ft-lbs. using 1/2" wrenches. **See Photo 7.**
13. Using rubbing alcohol as a lubricant, place the (4) supplied sleeves into shock eyelets. The 4" kit uses shock number **658695** and the 6" kit uses shock number **658708**.
14. Remove spare tire from under truck.
15. Remove the 3 clips from the spare tire heat shield and remove the shield. **See Photo 8.**

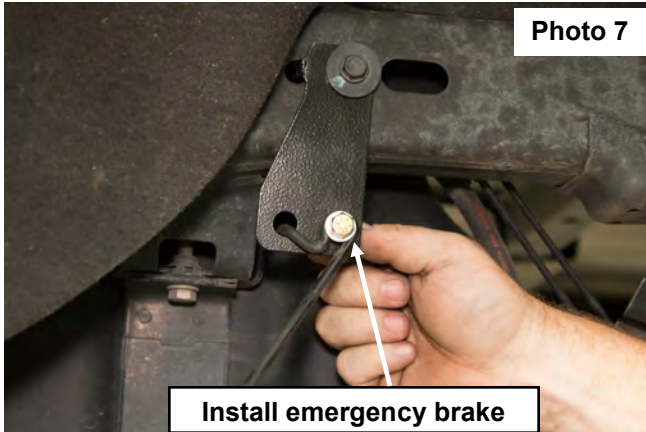

Install emergency brake

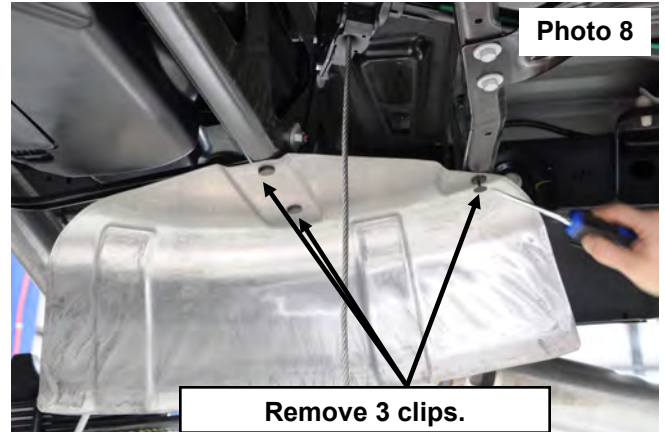

Remove 3 clips.

16. Using a 13mm socket, remove the 5 bolts holding the diesel exhaust fluid tank. **See Photo 9.**
17. Remove the tank straps and slide the tank forward. Now you can remove the upper shock bolt.
18. Using the factory hardware, place the upper eyelet of the shock into the upper mount. **See Photo 10.**

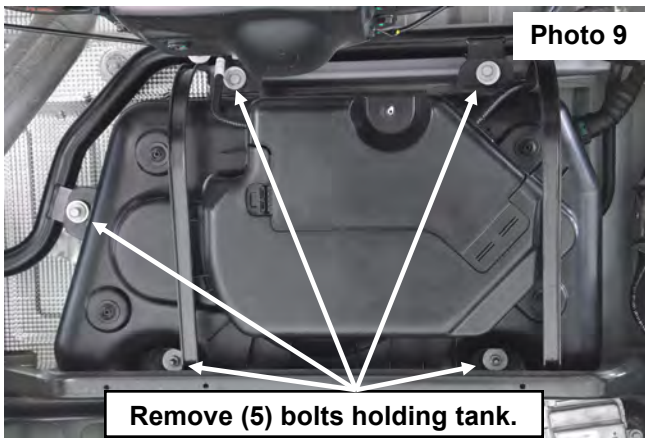

Remove (5) bolts holding tank.



Install rear shock.

19. Using the factory hardware, place the lower eyelet of the shock into the lower mount. **See Photo 11.**
20. Torque the shock mounts to 60 ft-lbs. using 21mm socket and wrench. **See Photo 12.**

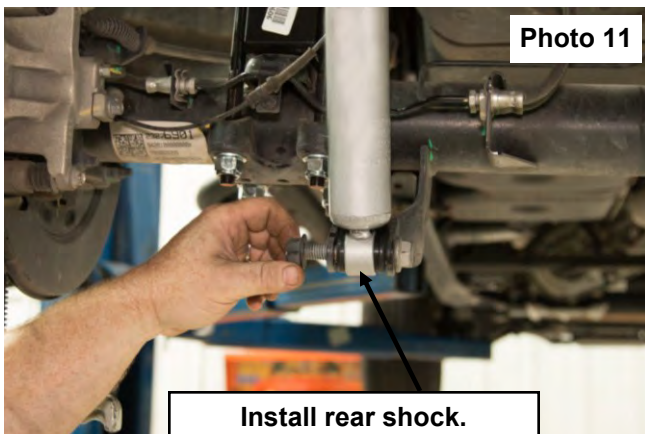

Install rear shock.

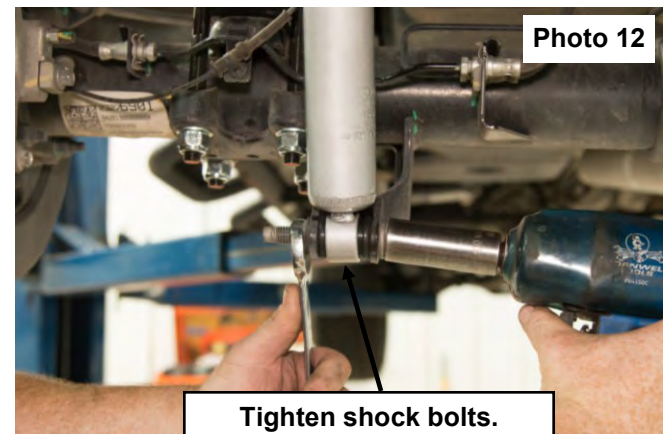

Tighten shock bolts.

21. Place tank back in factory location, Torque the straps and (5) bolts that hold the tank in place to 15 ft-lbs.
22. Install wheels and tires and lug nuts.
23. Lower the vehicle to the ground.

POST INSTALLATION INSTRUCTIONS

1. Check all fasteners for proper torque. Check to ensure for adequate clearance between all rotating, mobile, fixed, and heated members. Verify clearance between exhaust and brake lines, fuel lines, fuel tank, floor boards and wiring harness. Check steering gear for clearance. Test and inspect brake system.
2. On some vehicles the front lower skirting will need to be trimmed if using certain wheel /tire combinations and with heavy offset wheels. Trim only as needed.
3. Activate four wheel drive system and check front hubs for engagement.
4. Have a qualified alignment center align the vehicle immediately. Realign to factory specifications. Have headlights adjusted to proper settings.
6. Perform head light check and adjustment to proper settings.
7. Check and retighten wheels at 50 miles and again at 500 miles.
8. Recheck lifted height and adjust torsion bar as necessary.
9. All kit components must be retightened at 500 miles and then every three thousand miles after installation. Periodically check all hardware for tightness.
10. Install "Warning to Driver" decal on sun visor.

Alignment Specs

Front			
Total Toe	-0.10°	+0.10°	+0.30°
Front Camber	-0.90°	-0.10°	+0.70°
Caster	+1.80°	+2.80°	+3.80°
King-Pin	_____	_____	_____
Incl. Angle	_____	_____	_____
Rear			
Total Toe	°	°	°
Rear Camber	°	°	°
Thrust Angle	-.025°	+0.00°	+0.25°



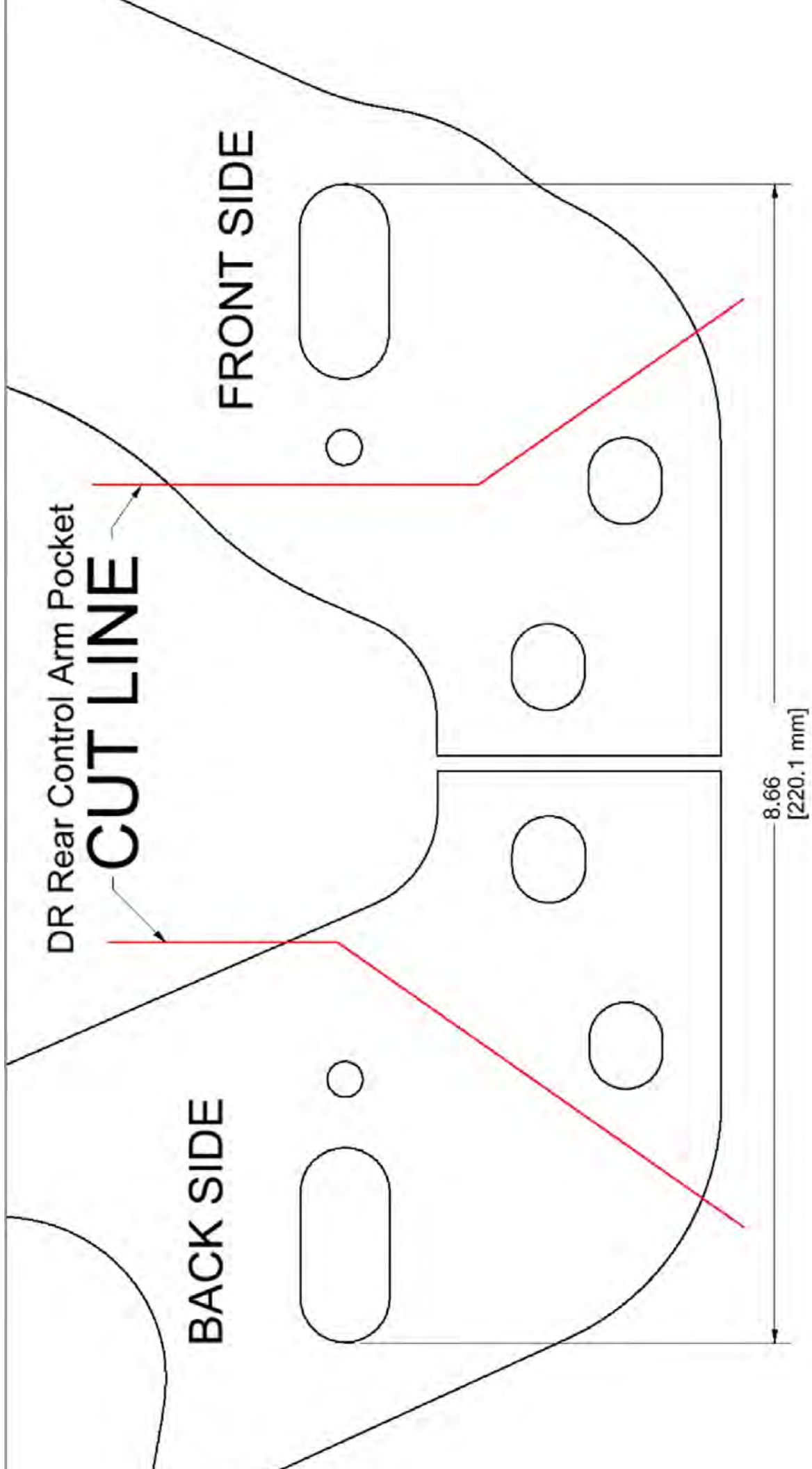

Driveshaft Spacer Install

1. Using a 10mm socket, remove the (6) bolts connecting the front driveshaft to the front differential. Keep the bolt plates for later use **See Photo 1.**



2. Place supplied aluminum spacer in between driveshaft and front differential. **See Photo 2.**
3. Place driveshaft in spacer and align holes. Install supplied 10mm x 70mm socket head cap screws from 1241BAG2, **make sure to use a thread locker on these bolts. See Photo 3.**
4. Torque to 35 ft-lbs. using an 8mm allen socket. **See Photo 4.**



Thank you for choosing Rough Country for all of your suspension needs.

By purchasing any item sold by Rough Country, LLC, the buyer expressly warrants that he/she is in compliance with all applicable , State, and Local laws and regulations regarding the purchase, ownership, and use of the item. It shall be the buyers responsibility to comply with all Federal, State and Local laws governing the sales of any items listed, illustrated or sold. The buyer expressly agrees to indemnify and hold harmless Rough Country, LLC for all claims resulting directly or indirectly from the purchase, ownership, or use of the items.

