



CHEVY 2011-18 2500/3500 Rear Air Spring Kit

Thank you for choosing Rough Country for all your vehicle needs.

Please read instructions before beginning installation. Check the kit hardware against the kit contents shown below. Be sure you have all needed parts and know where they go.

If question exist, please call us @1-800-222-7023. We will be happy to answer any questions concerning this product. Check all fasteners for proper torque. Check to ensure for adequate clearance between all components. Periodically check all hardware for tightness.

Rough Country recommends a certified technician installs this system. In addition to these instructions, professional knowledge of disassemble/reassembly procedures as well as post installation checks must be known. Attempts to install this system without this knowledge and expertise may jeopardize the integrity and/or operating safety of the vehicle.

⚠ WARNING

PRODUCT USE INFORMATION
As a general rule, the taller a vehicle is the easier it will roll. We strongly recommend, because of rollover possibility, that seat belts and shoulder harnesses should be worn at all times. Avoid situations where a side rollover may occur. Braking performance and capabilities are decreased when significantly larger/heavier tires and wheels are used. Take this into consideration while driving. Also, speedometer recalibration is necessary when larger tires are installed. Do not add, alter, or fabricate any factory or after-market parts which increase vehicle height over the intended height of the Rough Country product purchased. Mixing component brands, lifts, with this suspension lifts voids all warranties. Rough Country makes no claims regarding lifting devices and excludes any and all implied claims. We will not be responsible for any product that is altered.

⚠ NOTICE NOTICE TO DEALER AND VEHICLE OWNER

Any vehicle equipped with any Rough country product must have the "Warning to Driver" decal installed on the sun visor or dash. The decal is to act as a constant reminder for whoever is operating the vehicle of its unique handling characteristics. **INSTALLING DEALER**—It is your responsibility to install the warning decal and to forward these installation instructions on too the vehicle owner for review and to be kept in the vehicle for its service life.

⚠ NOTICE

Note to installer: Before installation begins we recommend that a test drive be performed. While driving check for uncommon sounds and/or vibrations . What you feel and hear during the test drive will only magnify once lift kit is installed. Advise you to discuss possible issues identified from drive with customer before proceeding to install this kit.

⚠ NOTICE Airbags will not increase the maximum load capacity.

Torque Specs:

Size	Grade 5	Grade 8	Size	Class 8.8	Class 10.9
5/16"	15 ft/lbs	20ft/lbs	6MM	5ft/lbs	9ft/lbs
3/8"	30 ft/lbs	35ft/lbs	8MM	18ft/lbs	23ft/lbs
7/16"	45 ft/lbs	60ft/lbs	10MM	32ft/lbs	45ft/lbs
1/2"	65 ft/lbs	90ft/lbs	12MM	55ft/lbs	75ft/lbs
9/16"	95 ft/lbs	130ft/lbs	14MM	85ft/lbs	120ft/lbs
5/8"	135ft/lbs	175ft/lbs	16MM	130ft/lbs	165ft/lbs
3/4"	185ft/lbs	280ft/lbs	18MM	170ft/lbs	240ft/lbs

⚠ NOTICE

Min/Max psi for Airbags:

5-100 psi



Kit Contents:

Air Bag x2
Dr Upper Bracket x1
Pass Upper Bracket x1
Lower Bracket x2
Lower Strap x2
Heat Shield x1
90° Fitting x2
Inflation Valve x2

Lift Application Only

Spacer x2

Tools Needed:

Flat Head Screwdriver
9/16" Socket/Wrench
Drill
21/64" Drill Bit

Hardware Included:

3/8" x 3/4" Flat Head Bolts x8
3/8" x 2" Carriage Bolts x4
3/8" x 4-7/8" x 6-1/4" Sq U-Bolts x4
3/8" x 1" Self-tapping Bolts x4
3/8" Flange Nuts x12
8MM x 20MM Bolts x3
8MM Flat Washers x3
1/4" DOT Air Line x20ft
Hose Clamps x2
Cable Ties x6

Lift Application Only

3/8" x 1" Bolts x4
3/8" Flat Washers x4
3/8" Lock Washers x4



INSTALLATION INSTRUCTIONS

Instructions are shown on a stock application. Lifted vehicles will have the same installation with the addition of a spacer between the air bag and lower bracket. See Photo 2.

1. Jack up the rear of the vehicle and place on jack stands. Remove the rear wheels.
2. Remove the rear bump stop using a pry bar or large flat head screwdriver. See Photo 1.



3. Install the air bag assembly. See Photo 2.
Install the Upper Bracket and Lower Bracket to the air bag using the 3/8" x 3/4" Flat head bolts (7/32" Allen wrench).
Install the 90° fitting in the top of the air bag using a 9/16" wrench after the Upper Bracket has been installed.

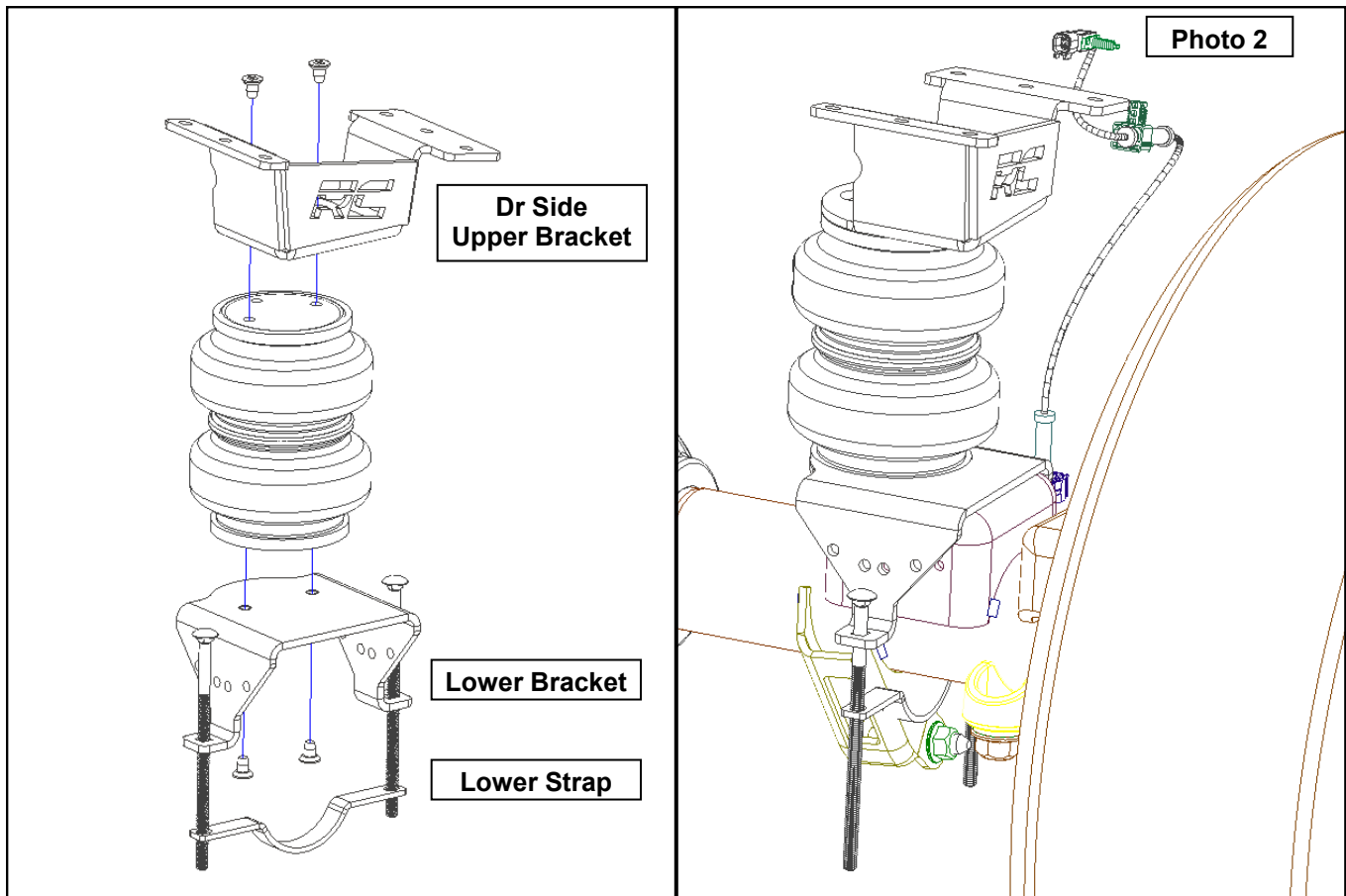

4. Install the driver and passenger side brake line brackets with the 8MMx20MM bolts and washers using a 13mm socket/wrench. **See Photo 3, Photo 4, and Photo 5.**

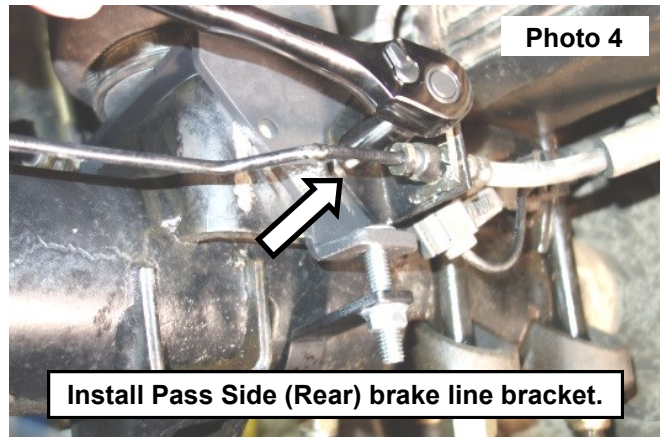
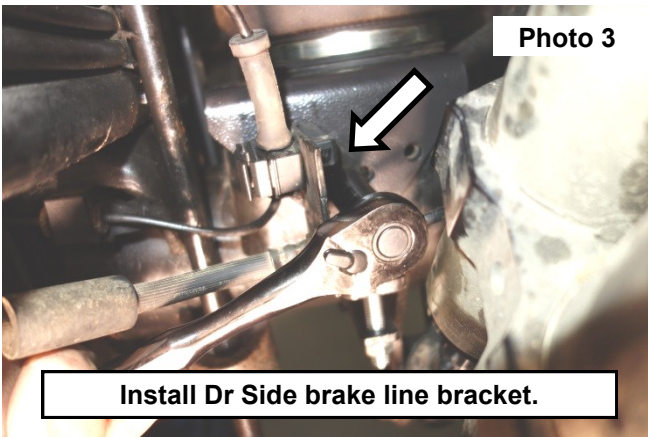

5. Install the inflation valve through the license plate and install the DOT air line to both valves. **See Photo 6.**

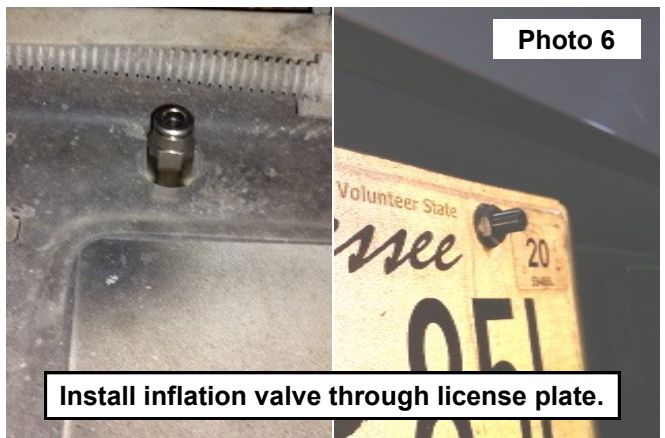
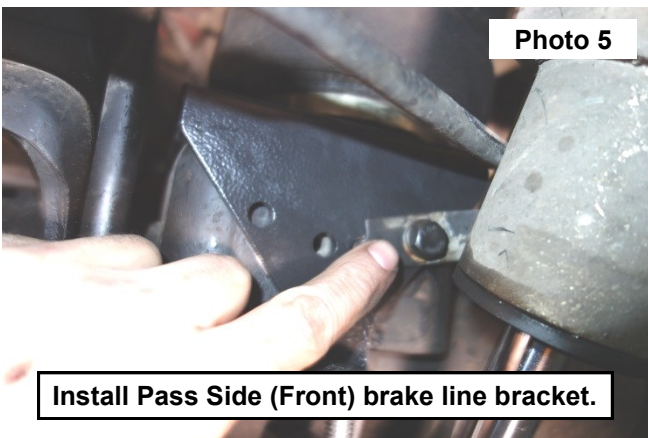

6. **For vehicles with gooseneck hitch:**
Raise the suspension up so the upper bracket is touching the frame and mark with a paint pen. Lower the suspension and drill using a 21/64" drill bit. **See Photo 7.**
7. Install the upper bracket with the 3/8"x1" bolts using 9/16" socket/wrench. **See Photo 8.**

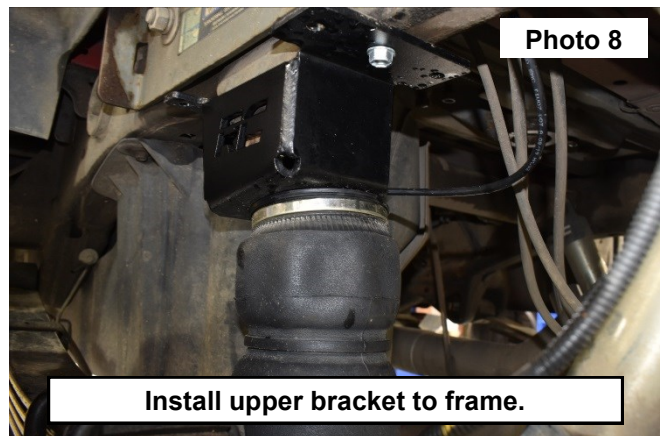

8. **For vehicle without gooseneck hitch:**

Install the upper bracket to the frame using the supplied 3/8 x 4-7/8 x 6-1/4 square U-bolt and flange nuts.
See Photo 9.

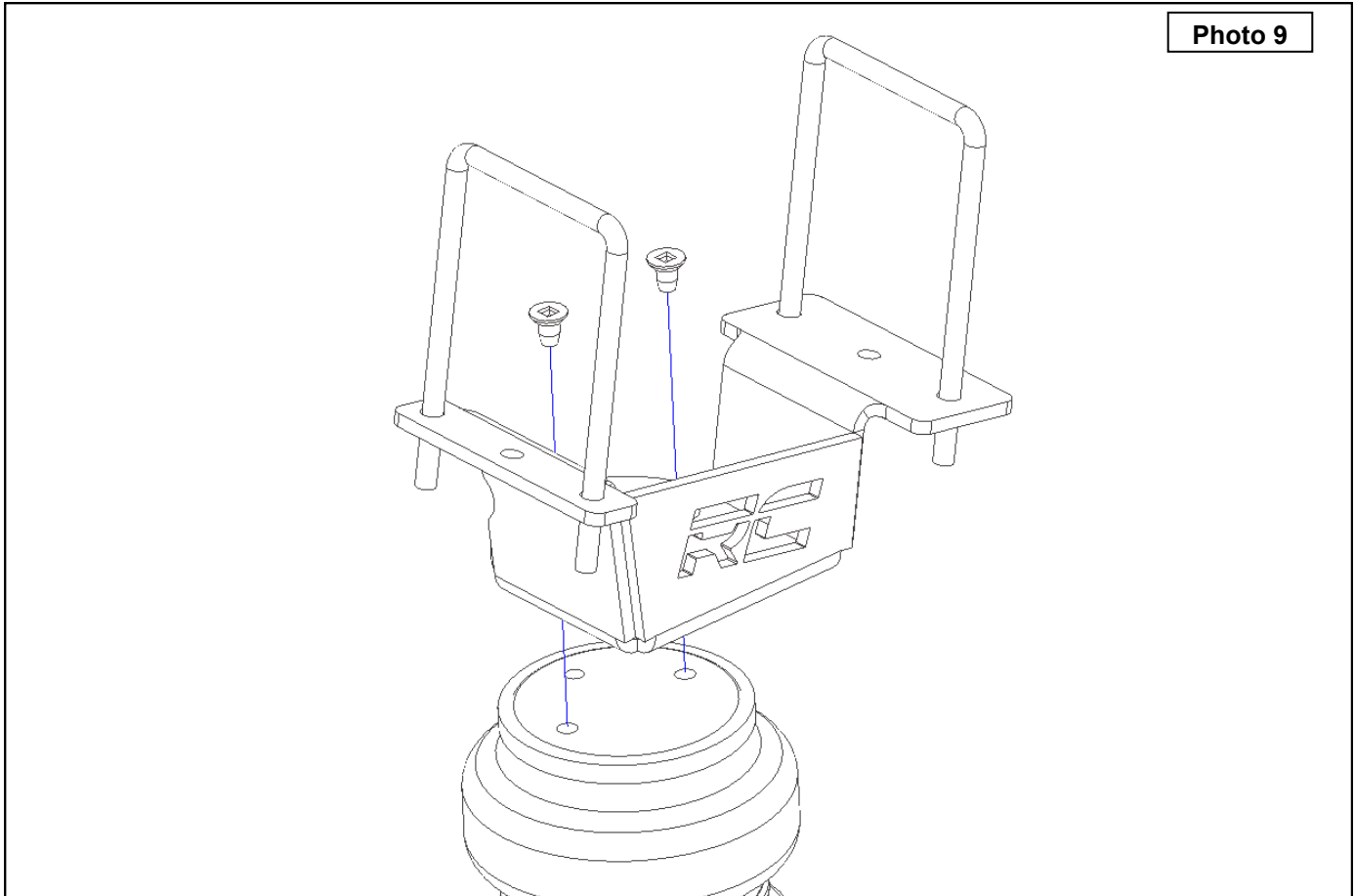

By purchasing any item sold by Rough Country, LLC, the buyer expressly warrants that he/she is in compliance with all applicable, State, and Local laws and regulations regarding the purchase, ownership, and use of the item. It shall be the buyers responsibility to comply with all Federal, State and Local laws governing the sales of any items listed, illustrated or sold. The buyer expressly agrees to indemnify and hold harmless Rough Country, LLC for all claims resulting directly or indirectly from the purchase, ownership, or use of the items.

