



INSTALLATION INSTRUCTIONS

Trans4mer Gen II Mount System For 2011-2012 Ford Super Duty Bracket Kit 90155

Your safety, and the safety of others, is very important. To help you make informed decisions about safety, we have provided installation and operating instructions and other information on labels and in this guide. This information alerts you to potential hazards that could hurt you or others. It is not possible to warn you about all potential hazards associated with this product; you must use your own good judgment.

CARELESS INSTALLATION AND OPERATION CAN RESULT IN SERIOUS INJURY OR EQUIPMENT DAMAGE.
READ AND UNDERSTAND ALL SAFETY PRECAUTIONS AND OPERATING INSTRUCTIONS BEFORE INSTALLING AND OPERATING THIS PRODUCT.

This guide identifies potential hazards and has important safety messages that help you and others avoid personal injury or death. **WARNING** and **CAUTION** are signal words that identify the level of hazard. These signal words mean:

WARNING signals a hazard that could cause serious injury or death, if you do not follow recommendations.

CAUTION signals a hazard that may cause minor to moderate injury, if you do not follow recommendations.

This guide uses **NOTICE** to call attention to important mechanical information, and **Note**: to emphasize general information worthy of special attention.

WARNING

Failure to observe these instructions could lead to severe injury or death.

- Always** use extreme caution when drilling on any vehicle. Make sure that all fuel lines, brake lines, electrical wires, and other objects are not punctured or damaged when/if drilling on the vehicle. Thoroughly inspect the area to be drilled (on both sides of material) prior to drilling, and relocate any objects that may be damaged. Failure to inspect the area to be drilled may result in vehicle damage, electrical shock, fire or personal injury.
- Always** wear safety glasses when installing this kit. A drilling operation will cause flying metal chips. Flying chips can cause eye injury.
- Always** use extreme caution when cutting and trimming during fitting.
- Always** remove jewelry and wear eye protection.
- Always** use appropriate and adequate care in lifting components into place.
- Always** insure components will remain secure during installation and operation.
- Always** tighten all nuts and bolts securely, per the installation instructions.

WARNING

Failure to observe these instructions could lead to severe injury or death.

- Always** securely tighten all bolts on the winch plate, winch, and fairlead. Loose bolts can result in product failure which may result in vehicle damage and operator injury or death.
- Always** double check that all bolts are securely tightened prior to use.

This WARN Trans4mer Gen II system can be customized to give your vehicle a wide variety of looks, front-end protection and winch mounting capability. The system starts with this winch carrier that attaches to the truck's frame with brackets designed to handle up to a 16500 lb winch. This provides a mounting location for a Warn winch. It is durable and good looking as a stand-alone grille guard, but can be easily upgraded with some great options! You can first add a center Grille Guard Tube that provides a mounting location for other accessories. You can add a light bar that adds even more protection and includes tabs for mounting auxiliary lights. You can mount a front receiver bracket that provides a mounting location for a multi-mount Warn winch. You may also add a receiver bracket that will handle the Warn multi-mount winch system. Finally, brush guards that protect the headlights and front corners of the vehicle can be easily added to any of the options above.

Before You Begin

- Read and understand these Installation Instructions.
- Refer to the Parts List below and to Figures A and B for your specific mounting system to become familiar with the components and hardware in this kit.

I. PARTS LIST FOR 90155 Bracket Kit

<u>Part Number.</u>	<u>Qty</u>	<u>Description</u>
84512	1	Upper Mtg Bracket, LH
84513	1	Upper Mtg Bracket, RH
84517	1	Hardware kit
84273	1	Frame Extension, RH
84274	1	Frame Extension, LH
84284	5	Shim, Lower

II. EXPLODED VIEW DIAGRAMS

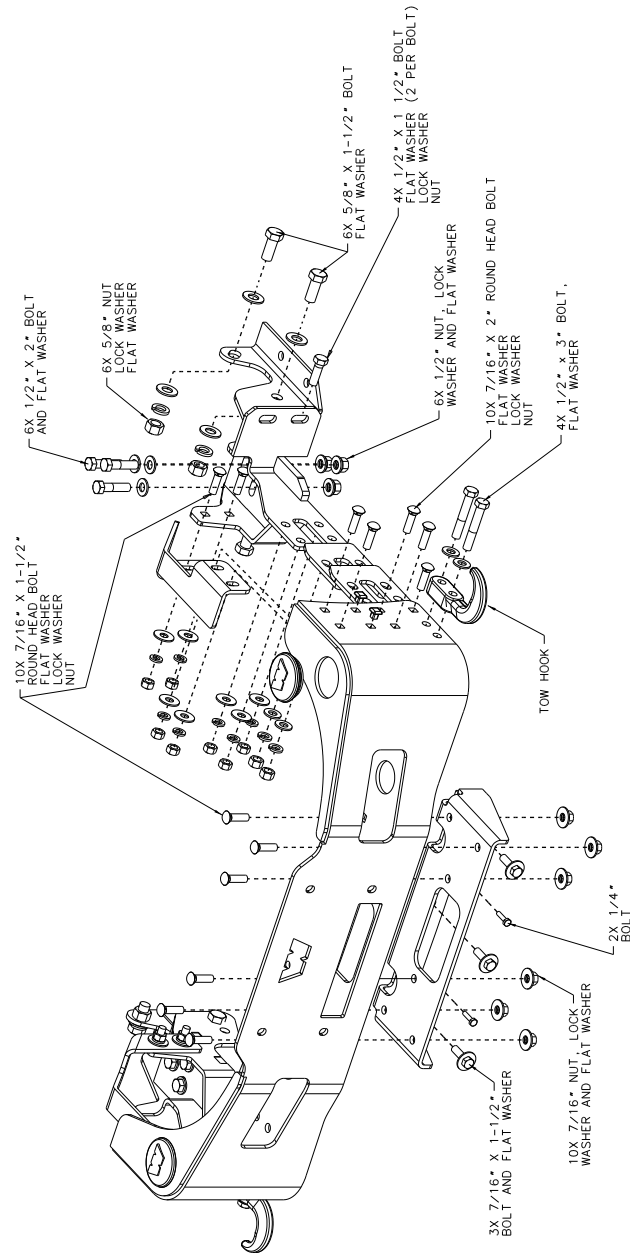

Figure A: Large Frame Exploded View

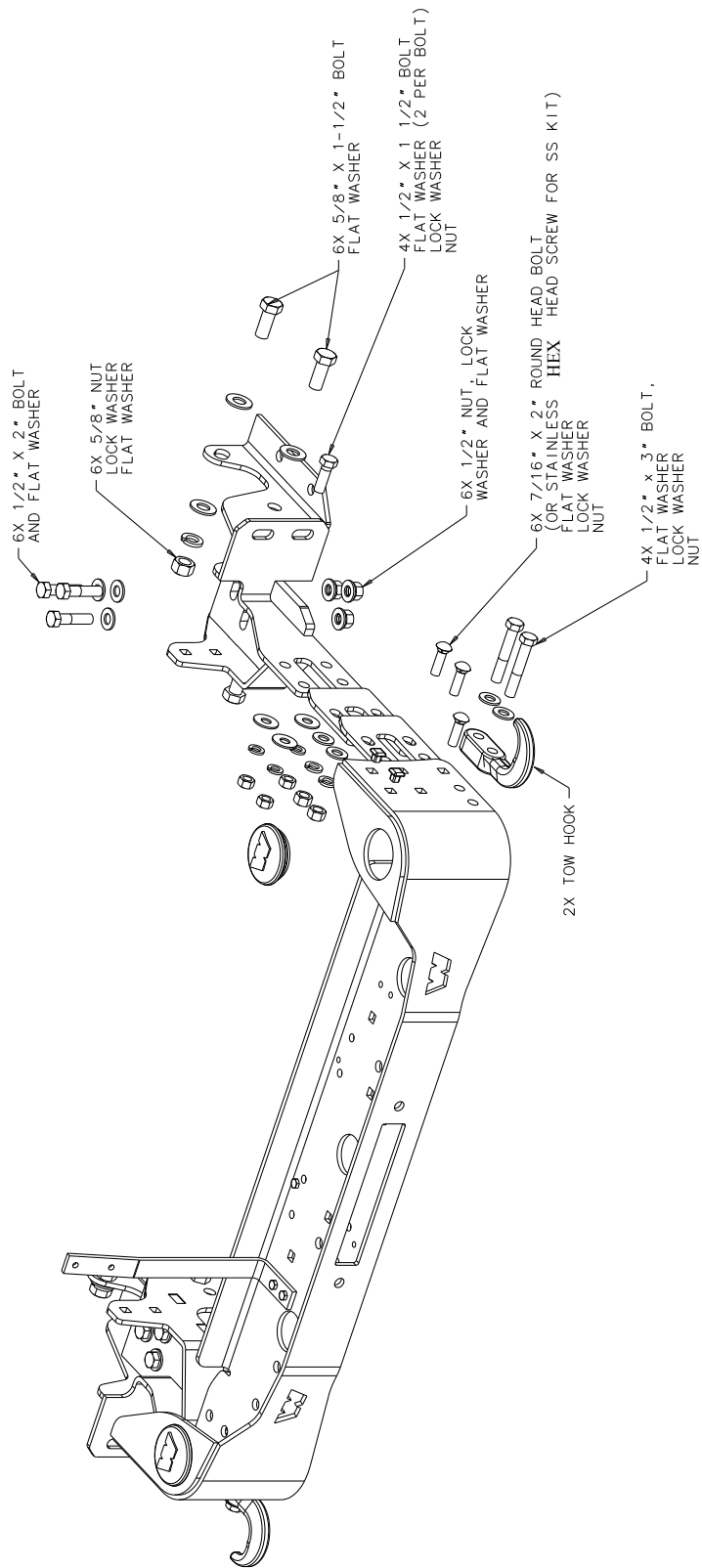

Figure B: Mid Frame Exploded View

NOTE: Follow the instructions step by step for fastest installation. Do not securely tighten fasteners until directed to do so.

III. TORQUE SPECIFICATIONS

BOLT SIZE	TORQUE
3/8 inch	30 lb. ft (40.7 N-m)
7/16 inch	50 lb. ft. (67.8 N-m)
1/2 & 5/8 inch	75 lb. ft. (101.7 N-m)

IV. VEHICLE PREPARATION

1. Remove the rear bumper bolts (2 per side)

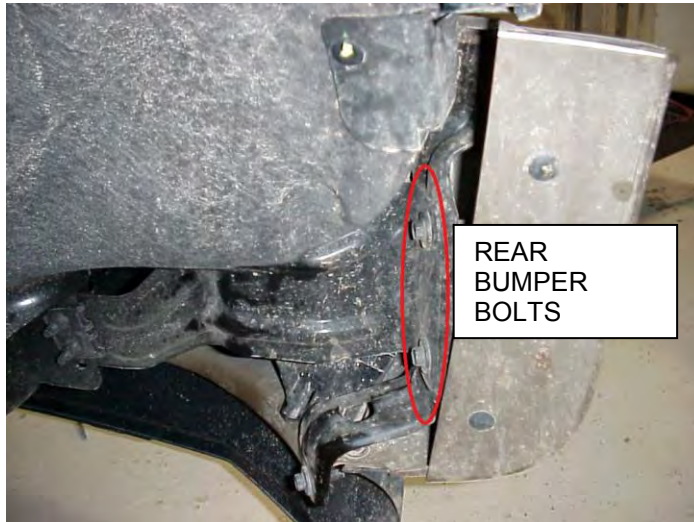

Figure C

2. Remove plastic fasteners securing rubber air deflector.

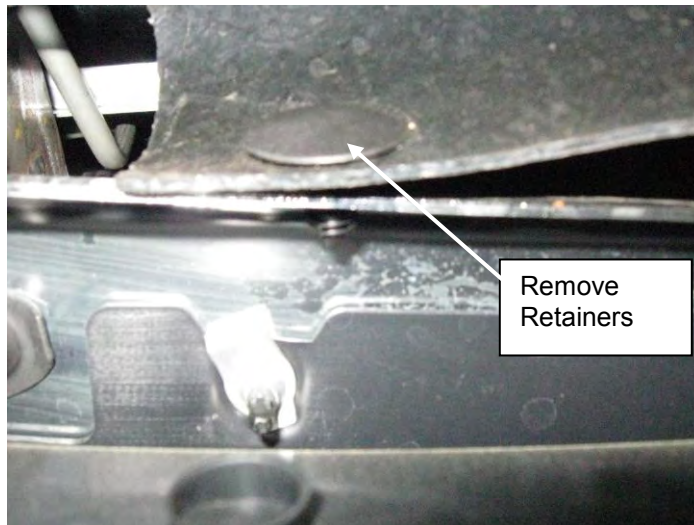

Figure D

3. Remove 4 bumper bolts from the front of the bumper as shown.

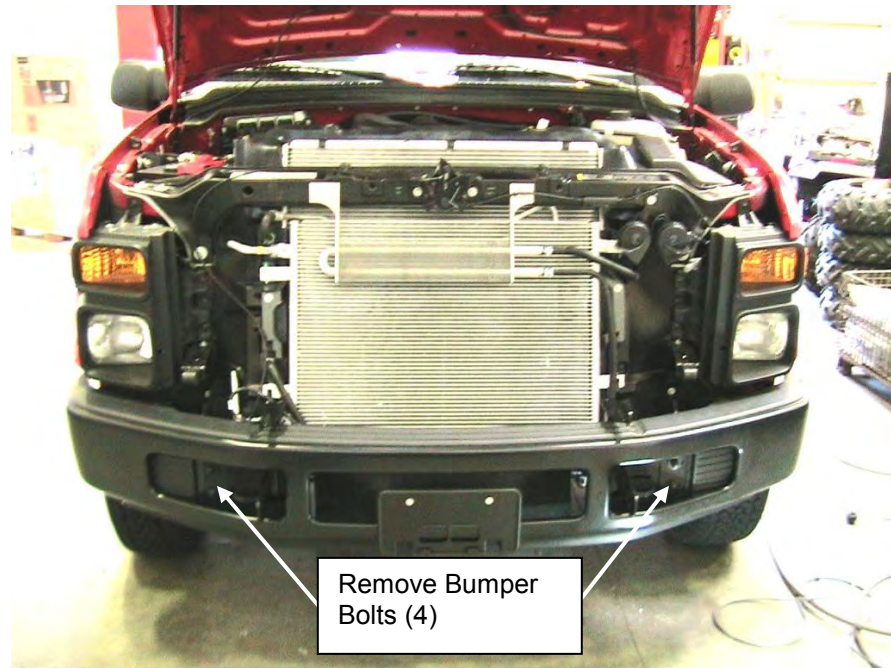

Figure E

4. Remove the bumper and set it aside.
5. Remove three bolts from each tow loop and discard the tow loops and tow loop bolts.

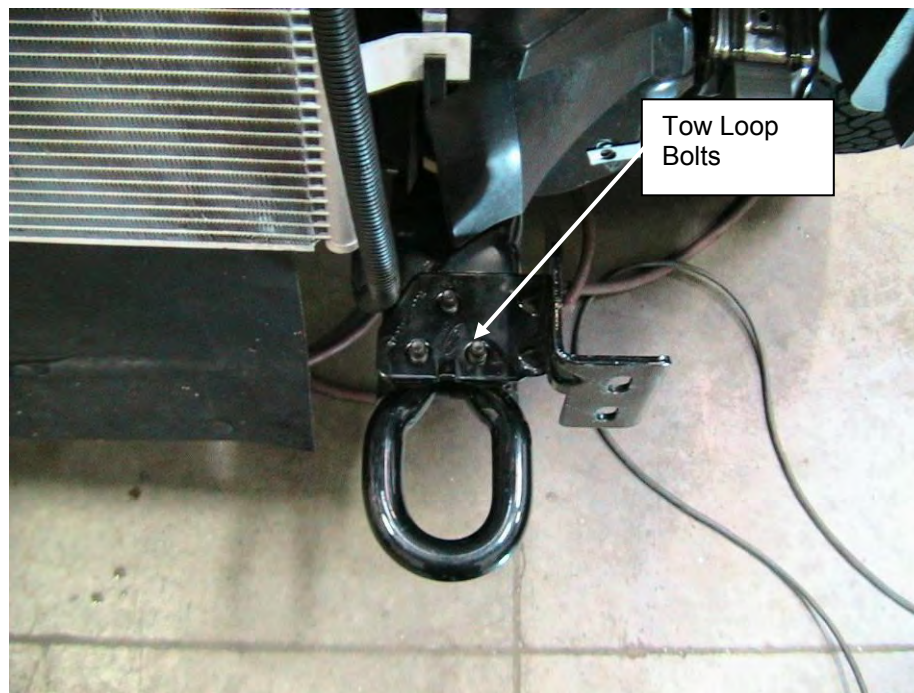

Figure F

6. Remove 4 bolts along top of grille.

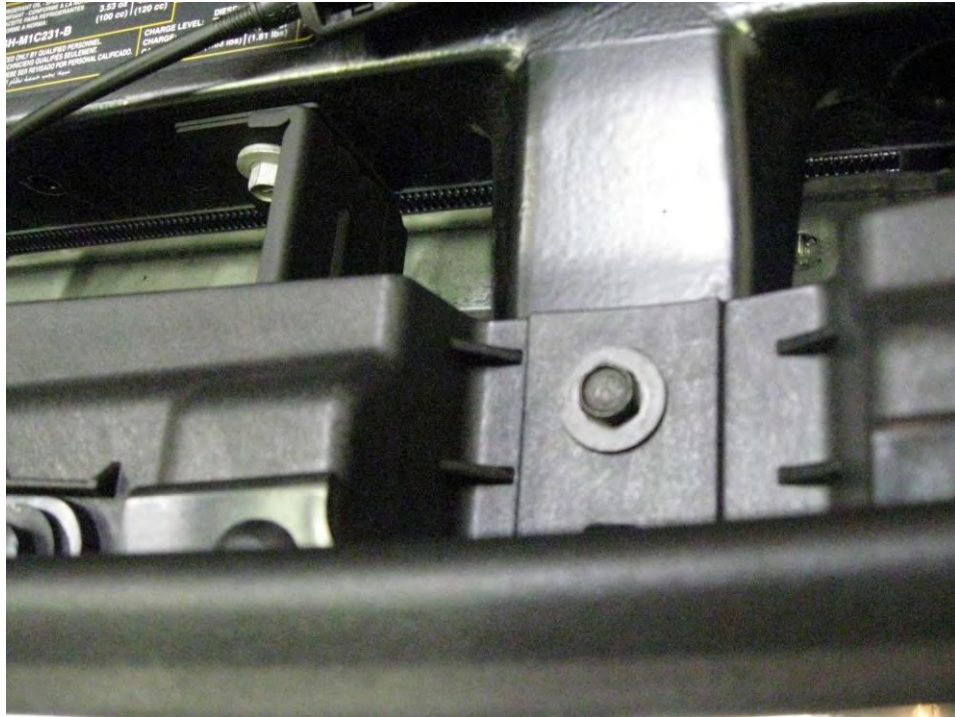

Figure G

7. Rotate grille slightly forward and using a long screw driver press down gently on the front of each metal retainer clip to release the grille. Once all 5 clips are removed, set grille aside.

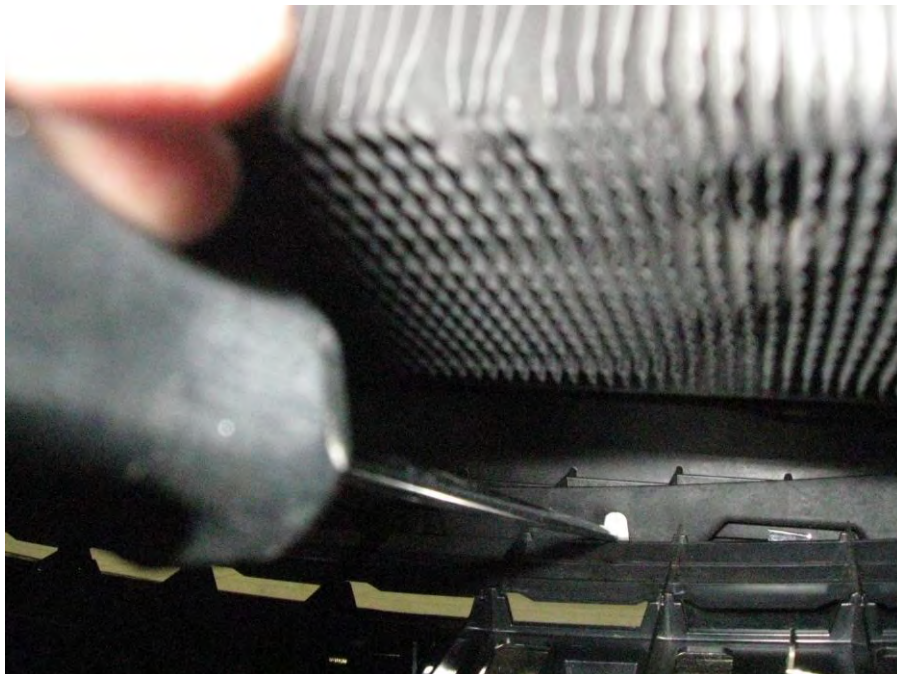

Figure H

V. INSTALLATION

1. Install the frame bracket on the driver's side frame by setting the bracket on the frame and tilting it back to allow the rear part of the bracket to slide past the body mount bracket. It may be necessary to lightly tap the frame bracket into place. Be very careful not to damage any vehicle parts while installing the brackets. Intercoolers and hoses are close to the brackets so care should be taken not to damage, kink, or cut the hoses during installation. Once the frame bracket is in place and holes are lined up with the holes in the frame, repeat for passenger's side frame. (See figure 1.)

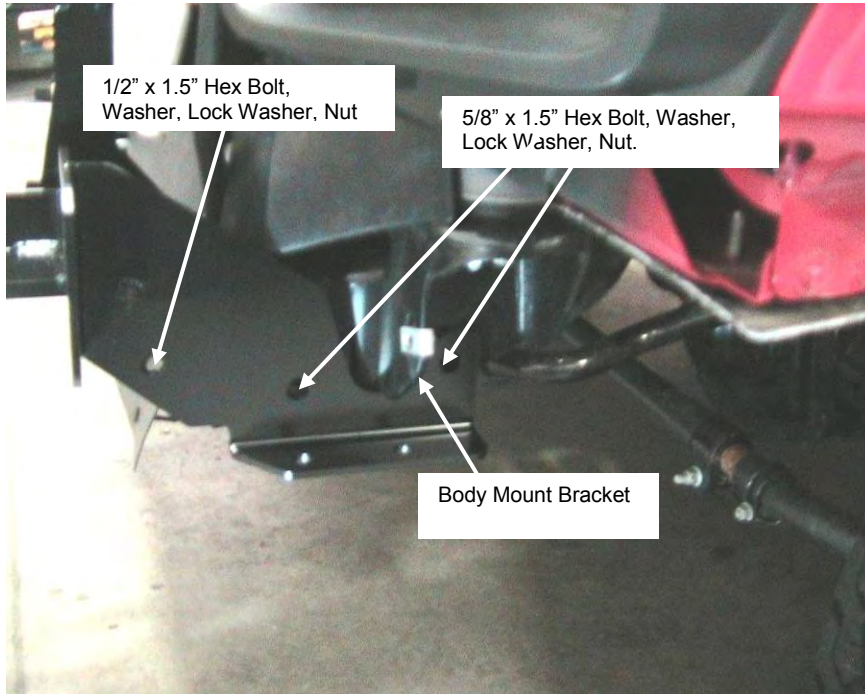

Figure 1: Placement of the Frame Bracket (Driver Side)

2. Install fasteners as shown in **Figure 1, 2 and 3**. Do not tighten any fasteners until instructed to do so.

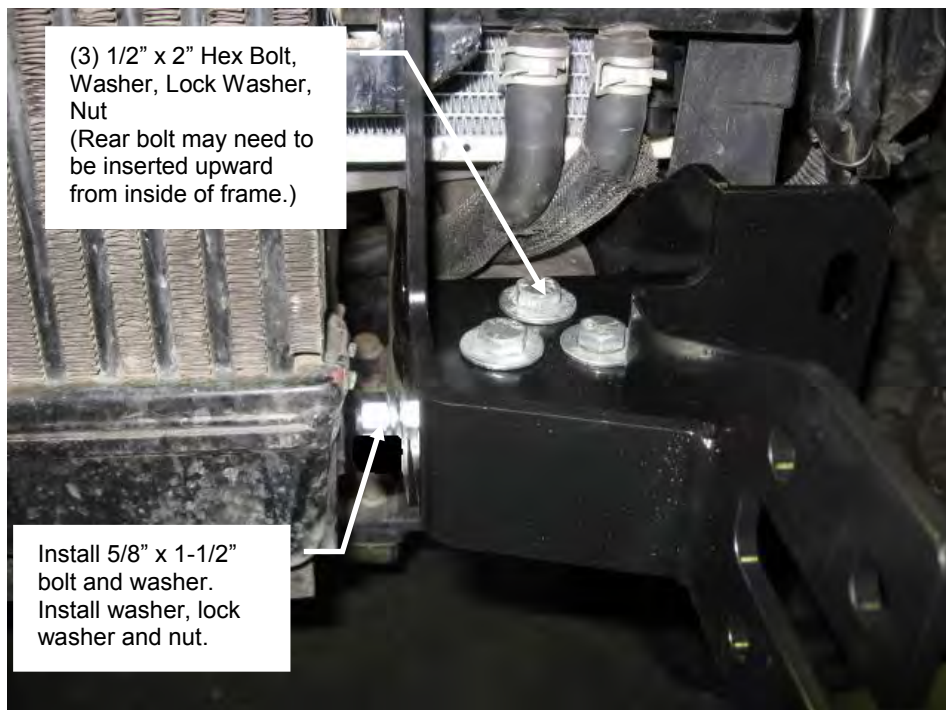

Figure 2: Top Frame Bolt Installation. (Driver Side)

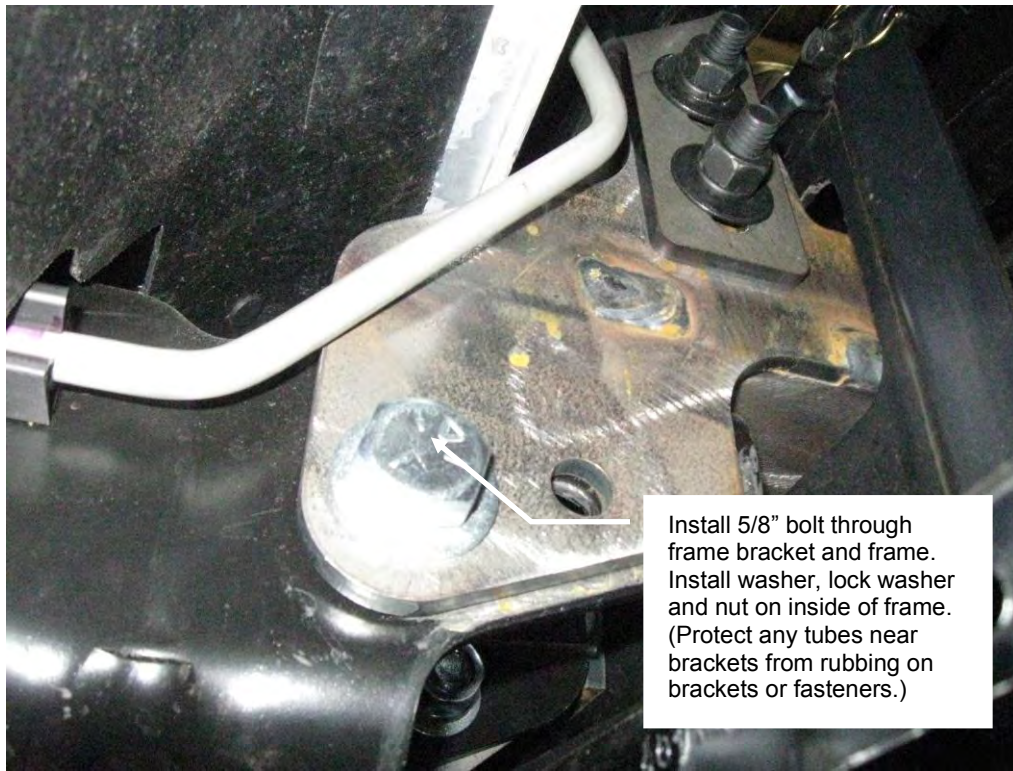

Figure 3: Frame Bolt Installation. (Passenger Side shown.)

3. Install all of the fasteners as shown in **Figure 1** through **Figure 3** for both sides of the vehicle frame. Torque all of the fasteners to their specified rating.

4. Trim slots in the factory bumper brackets to install the front bumper. See **Figure 4 and 5**. Use a drill motor with $\frac{1}{2}$ " bit and saw or use a cutting wheel or grinder to create the slots. The center of the slots should be $36\frac{1}{2}$ " apart.

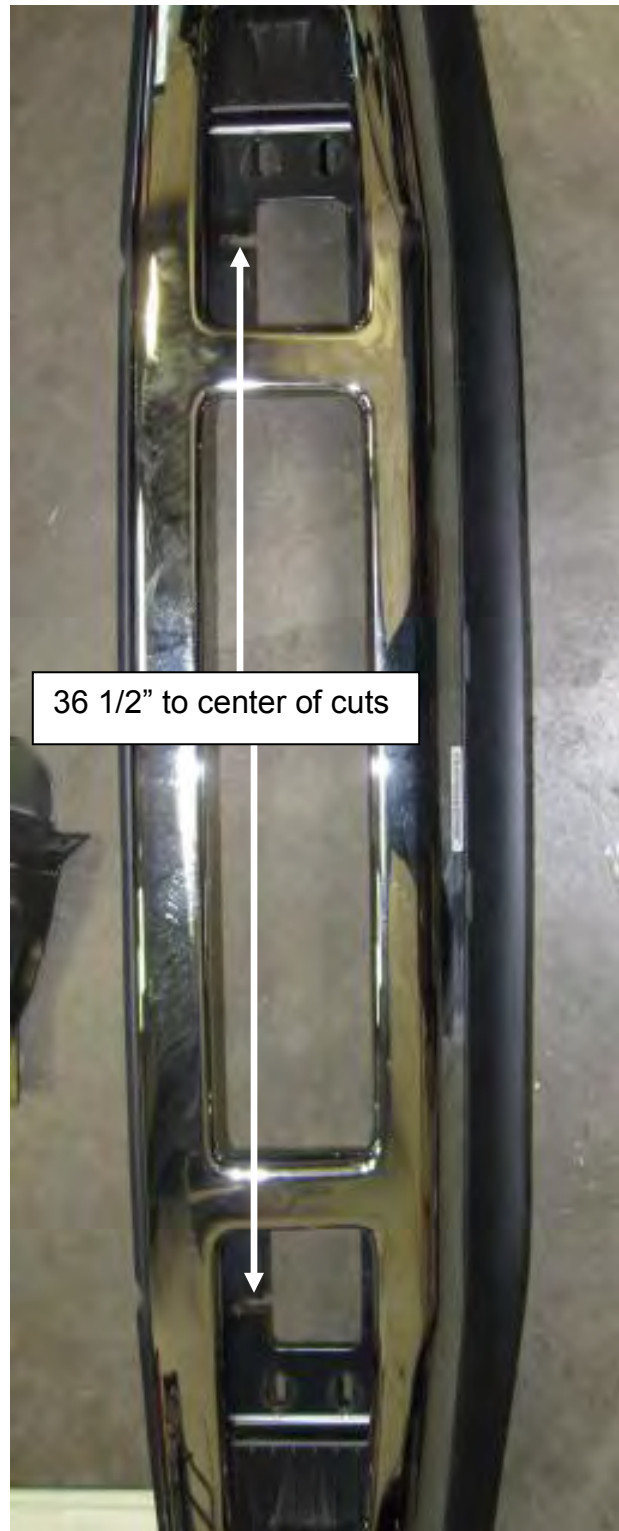

Figure 4: Cut slots in bumper brackets

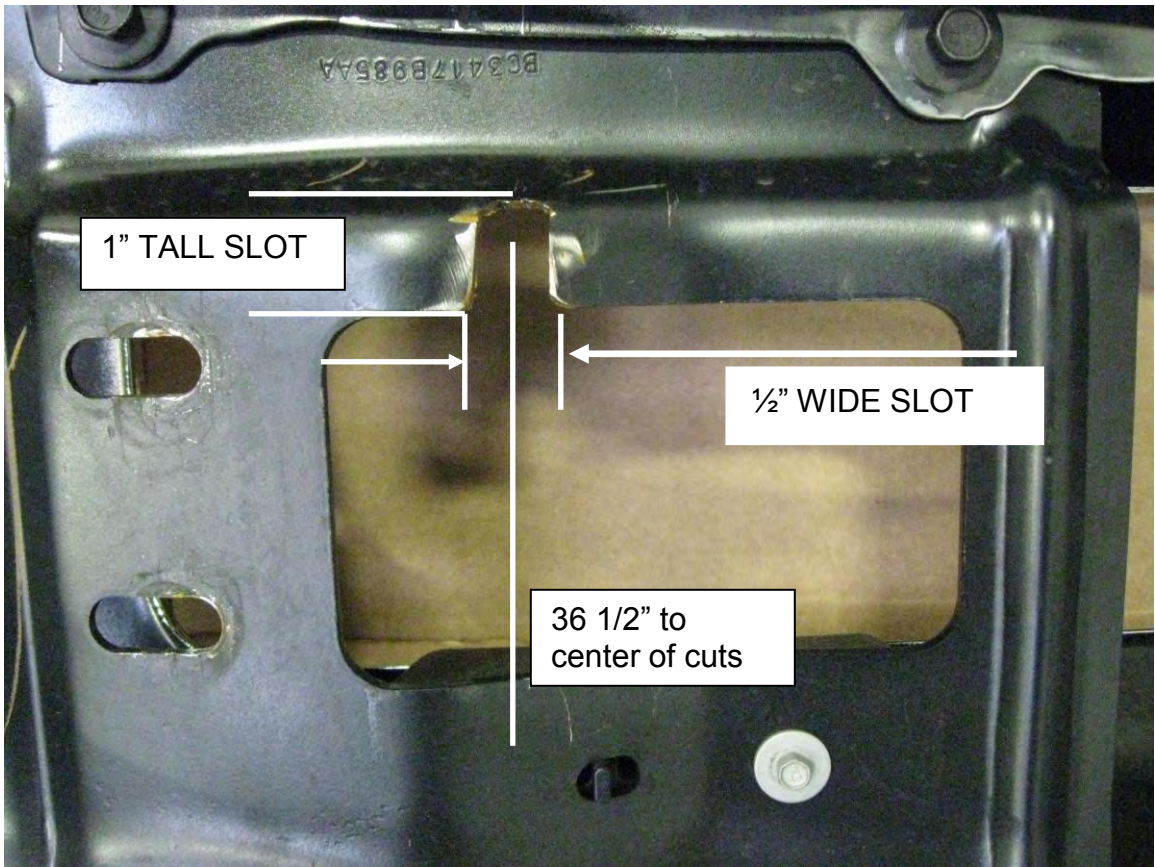

Figure 5: Driver's Side Shown. Cut slots in bumper brackets

⚠ WARNING



Drilling and Grinding operations can cause flying chips. **WEAR SAFETY GOGGLES.**
Flying chips can cause eye injury.

5. Reinstall the Bumper. Carefully slip the front bumper over the frame brackets. The slots that were cut into the bumper are there to provide more clearance to get over the frame bracket. Reinstall the four front bolts and six rear bolts. Align the bumper up and down and side to side and tighten.



Figure 6: Bumper Reinstalled.

6. Install the winch carrier to the mounting brackets. The inside dimension of the winch carrier is 38.0". Measure across the outside of the frame bracket. Subtract that from the 38.0" and that is the thickness of shims that will be required. Depending on your vehicle frame it may require you to use all 5 shims provided or none of them. The vehicle frame width has a tolerance of +/- 1.06". Warn has provided 5 1/4" thick shims for the frame mounting brackets. The upper mounting brackets are only used on Large Frame Carriers.

Use a helper and carefully slide the winch carrier and shims over the frame brackets. See **Figure 7**. Insert a 1/2 x 3" long bolt and washer through each of the 2 holes in the tow hook and then through the winch carrier, shims and mounting bracket. Install a 1/2" washer; lock washer and nut onto each bolt. Install the 3 lower 7/16" round head bolts through the hole directly behind the tow hook and the 2 holes directly above the tow hook. Install a 7/16" washer; lock washer and nut onto each of these three bolts. If you are installing a Stainless Steel Winch Carrier you will be installing 7/16" x 2" long hex head bolts and flat washers in place of the round head bolts. Do not tighten the bolts at this time.

Repeat this for the opposite side of the winch carrier.

Install two plastic plugs into the holes as shown in the figure. If you are installing Warn Head Light Guards at this time, do not install the plastic plugs. The plugs are not used on stainless kits.

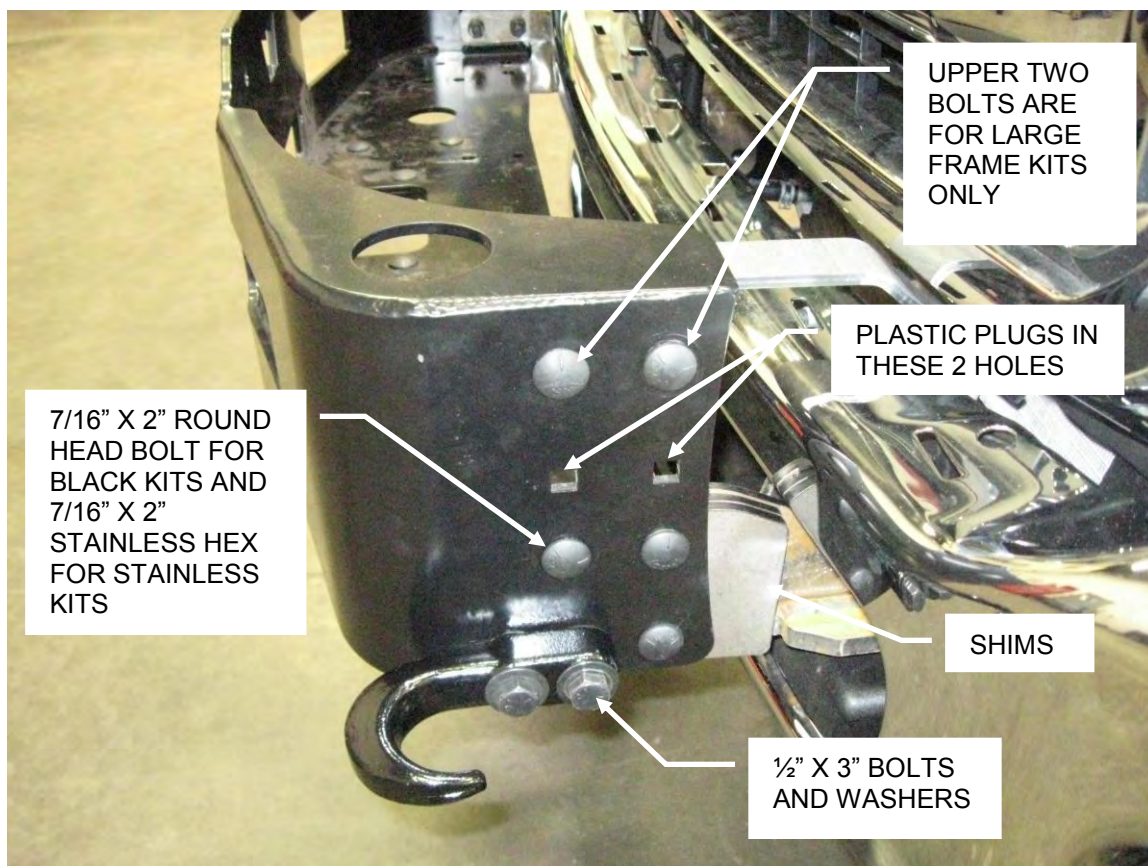

Figure 7: Winch Carrier Installation (Large Frame)

7. **Large Frame carrier only.** Install the upper frame brackets. Use **Figure 8** to determine the location of the left and right upper frame brackets. Install the upper frame bracket to the main frame bracket using the 7/16" x 1-1/2" round head bolts (hex bolts and flat washers in place of round head bolts for stainless kits). Install a bolt through each of the 2 holes in the main frame bracket and through the upper frame bracket. Install a 7/16" washer; lock washer and nut onto each bolt. Leave all fasteners very loose. Install the round head bolts through the winch carrier and upper frame bracket. Install a 7/16" washer; lock washer and nut onto each of the 2 bolts. Repeat this for the opposite side of the winch carrier. Adjust bracket height for best fit between bumper and grille then tighten all bolts to specified torque values.

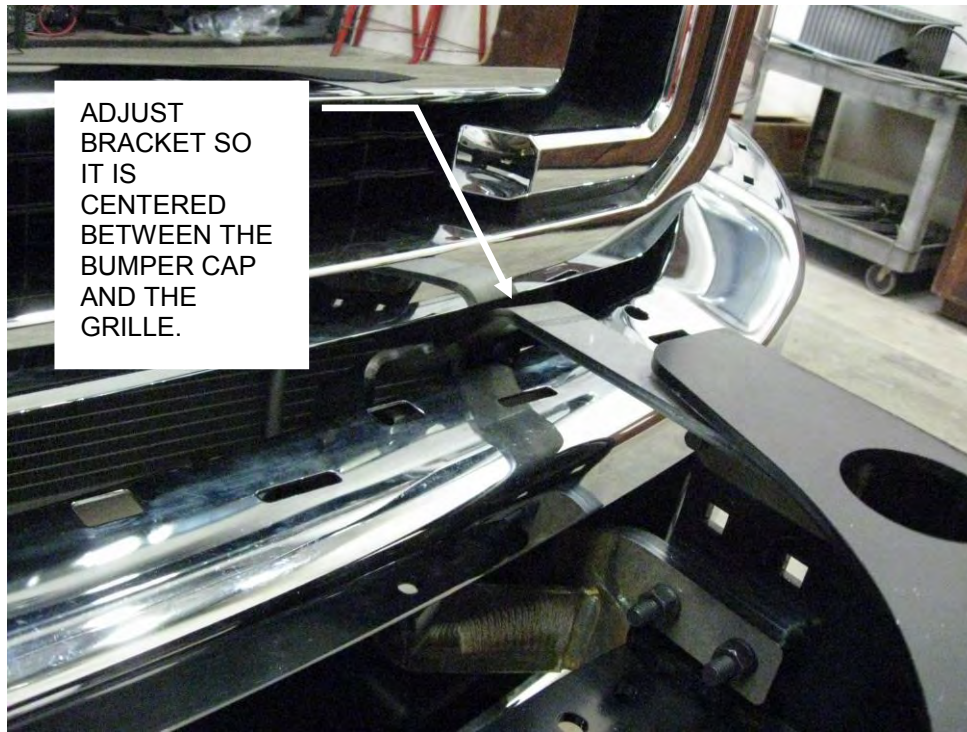

Figure 8: Driver's Side View. Upper Frame Brackets

8. If a Warn winch is being installed you can install it now. Install the winch per the installation instructions that came with the winch.
9. Double check that all mounting hardware for the frame brackets, factory bumper and winch carrier are at their proper torque or the factory torque.
10. If you are not installing a Warn Grille Guard Tube, install the 2 rubber plugs with the "W" into the large holes in the top of the winch carrier. See the exploded views in the beginning of this manual for location. Gently push the rubber plugs into place.
11. Install rubber air deflector by pushing black plastic retainers back through holes in bumper.



Figure 10: Finished kit (Winch and Fairlead Not Included)

⚠ WARNING

READ THE VEHICLE'S OPERATOR MANUAL, WINCH OPERATOR MANUAL, AND ALL WARNING LABELS PRIOR TO OPERATION OF WINCH.

⚠ WARNING

FAILURE TO SECURELY TIGHTEN ALL BOLTS ON THE WINCH PLATE, WINCH, AND FAIRLEAD CAN RESULT IN PRODUCT FAILURE WHICH MAY RESULT IN VEHICLE DAMAGE AND OPERATOR INJURY OR DEATH. DOUBLE CHECK THAT ALL BOLTS ARE SECURELY TIGHTENED PRIOR TO USE.

Warn Industries Stainless Steel Truck Accessories

What to expect:

Polished stainless steel combines the beauty of a chrome-like appearance with extreme durability and corrosion resistance. With a minimum amount of care, the appearance will last almost indefinitely. Unlike plating or coatings, there is nothing to peel off or wear away that would allow corrosion underneath.

The actual appearance may not be exactly like new chrome in either the degree of luster or color. There may be fine polishing lines visible up close and small differences between mating parts of an assembly. A grille guard, for instance, may have small differences between the round tubing and the flat plate. The backside of a part may not be as highly polished as the front. However, part of the beauty and appeal of stainless actually lies in the smooth “hand-worked” appearance.

There also is a possibility that small rust spots can appear on stainless products. They are usually due to minor iron contamination on the surface as a result of normal manufacturing and handling processes. This minor rust, if it occurs at all, is easy to remove and will not tend to spread.

Recommended care:

Regular washing with fresh water and mild car wash detergents followed by rinsing and drying with a soft towel is the best minimum care. Beyond that, any cleaner/wax recommended for automotive finishes will work well to remove minor stains and scuffs, enhance the shine and provide protection. Always use clean soft cotton cloths. In most cases, this will be all that is required for many years. For more serious blemishes or a rust spot, use a cream metal polish recommended for stainless, aluminum, etc. Try to rub in the direction of the original polishing lines.

Ultimately, any stainless part can be restored to a brilliant shine with power buffing processes.

Caution:

Do not use steel wool or any type of metal scraper. Do not use “Scotch Brite” pads or abrasive powdered cleaners. Do not try to clean with muriatic acid or any other acid.

Stainless Fasteners

Stainless steel fasteners are included in many of the stainless kits. These fasteners provide similar corrosion resistance and appearance as the rest of the kit. However, stainless fasteners are prone to galling when installed in similar stainless material. It is a good idea to apply a small amount of anti-seize compound to the threads when installing them. Care should also be taken when tightening the fasteners to prevent rounding or deforming the corners of the bolts. Make sure the wrenches are the correct size and fit properly. In the case of socket heads, the wrench should have sharp, un-worn edges. With a few precautions during assembly the products should provide years of service.

WARNING

PERFORM REGULAR INSPECTIONS ON THE WINCH, WINCH MOUNT, AND RELATED HARDWARE. NEVER OPERATE THE WINCH OR WINCH MOUNT WITH DAMAGED OR MISSING PARTS. FAILURE TO FOLLOW THIS WARNING MAY CAUSE VEHICLE DAMAGE AND OPERATOR INJURY OR DEATH.