

Warn Industries, Inc.

12900 S.E. Capps Road

Clackamas, OR USA 97015-8903

1-503-722-1200 FAX: 1-503-722-3000

www.warn.com

Customer Service / Service Clients: 1-800-543-9276

International Sales Support / Les Ventes internationales

Soutien: 1-503-722-3008

© 2011 Warn Industries, Inc.

WARN®, the WARN logo are registered trademarks of Warn Industries, Inc.

WARN® et le logo WARN sont des marques déposées de Warn Industries, Inc.

MID-FRAME WINCH WITH SYNTHETIC ROPE

***INSTALLATION AND OPERATOR'S GUIDE
GUIDE D'INSTALLATION ET OPERATEUR***



Winch Installation and Operator's Guide

Every winching situation has the potential for personal injury. In order to minimize that risk, it is important to read this guide and *The Basic Guide to Winching Techniques* carefully. Please familiarize yourself with the operation of your winch before using it, and be constantly safety oriented. In this guide, we will set forth many of the basic rules of safe winch operation. Please read *The Basic Guide to Winching Techniques* for more information on your winch and proper rigging techniques. Remember, because every winching situation is different, your constant good judgment and consistent focus on safety are of great importance.

TABLE OF CONTENTS:

SAFETY

Symbol Index..... 2
 General Safety Precautions 3-6
 Safe Working Conditions 7

INSTRUCTIONS

Mounting Winch..... 8
 Electrical Connections..... 9
 Operating Instructions 10-11
 Installing the Rope..... 12-13
 Rope Inspection 14-15

Warn Industries Inc.
 12900 SE Capps Road
 Clackamas, OR 97015
 USA

Customer Service: (800) 543-WARN
 (9276)
 International: (503) 722-1200
 Fax: (503) 722-3000



SYMBOL	EXPLANATION
	Read the Instruction Manual
	Always Wear Hearing and Eye Protection
	Never Use Winch as a Hoist
	Properly Seat Load in Throat of Hook
	Wind Rope on Bottom of Drum
	Finger/Fairlead Crushing Hazard
	Hand Piercing/Cutting Hazard
	Explosion/Bursting Hazard
	Sharp Edge Hazard

SYMBOL	EXPLANATION
	Always Wear Leather Gloves
	Do Not Move People
	Always Use Supplied Hook Strap
	Never Apply Load to Hook Tip or Latch
	Never Wind Rope Over Top of Drum
	Fairlead Pinch Point
	Hot Surface Hazard
	Fire and Burn Hazard
	Moving Parts Hazard

Warnings and Cautions

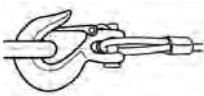

As you read these instructions, you will see WARNINGS, CAUTIONS, NOTICES and NOTES. Each message has a specific purpose. WARNINGS are safety messages that indicate a potentially hazardous situation, which, if not avoided could result in serious injury or death. CAUTIONS are safety messages that indicate a potentially hazardous situation which, if not avoided, could result in minor or moderate injury. A CAUTION may also be used to alert against unsafe practice. CAUTIONS and WARNINGS identify the hazard, indicate how to avoid the hazard, and advise of the probable consequence of not avoiding the hazard. NOTICES are messages to avoid property damage. NOTES are additional information to help you complete a procedure. **PLEASE WORK SAFELY!**

 WARNING	
	

MOVING PARTS ENTANGLEMENT HAZARD

Failure to observe these instructions could lead to serious injury or death.

- **Always** ensure hook latch is closed and not supporting load.
- **Never** apply load to hook tip or latch. Apply load only to the center of hook.
- **Never** use a hook whose throat opening has increased, or whose tip is bent or twisted.
- **Always** use a hook with a latch.
- **Always** ensure the operator and bystanders are aware of the stability of the vehicle and/or load.
- **Always** keep wired remote control lead and power cord clear of the drum, rope, and rigging. Inspect for cracks, pinches, frayed wires or loose connections. Damaged components must be replaced before operation.
- **Always** pass remote lead thru window when used in vehicle.

 WARNING	
	

MOVING PARTS ENTANGLEMENT HAZARD



Failure to observe these instructions could lead to serious injury or death.

General Safety:

- **Always** Know Your Winch. Take time to fully read the Instructions and/or Operations Guide, and/or Basic Guide to Winching Techniques, in order to understand your winch and its operations.
- **Never** exceed winch or winch rope rated capacity. Double line using a snatch block to reduce winch load.
- **Always** wear heavy leather gloves when handling winch rope.
- **Never** use winch or winch rope for towing. Shock loads can damage, overload and break rope.
- **Never** use a winch to secure a load.
- **Never** operate this winch when under the influence of drugs, alcohol or medication.
- **Never** operate this winch if you are under 16 years of age.

Installation Safety:

- **Always** choose a mounting location that is sufficiently strong to withstand the maximum pulling capacity of your winch.
- **Always** use grade 5 (grade 8.8 metric) or better hardware.
- **Never** weld mounting bolts.
- **Always** use factory approved mounting hardware, components, and accessories.
- **Never** use bolts that are too long.
- **Always** complete the winch installation and hook attachment before installing the wiring.
- **Always** keep hands clear of winch rope, hook loop, hook and fairlead opening during installation, operation, and when spooling in or out.
- **Always** position fairlead with warning readily visible on top.
- **Always** prestretch rope and respool under load before use. Tightly wound rope reduces chances of "binding", which can damage the rope.



 WARNING	
	

MOVING PARTS ENTANGLEMENT HAZARD

Failure to observe these instructions could lead to serious injury or death.

Winching Safety:

- **Always** inspect winch rope, hook, and slings before operating winch. Frayed, kinked or damaged winch rope must be replaced immediately. Damaged components must be replaced before operation. Protect parts from damage.
- **Always** remove any element or obstacle that may interfere with safe operation of the winch.
- **Always** be certain the anchor you select will withstand the load and the strap or chain will not slip.
- **Always** use supplied hook strap whenever spooling winch rope in or out, during installation and during operation.
- **Always** require operators and bystanders to be aware of vehicle and or load.
- **Always** be aware of stability of vehicle and load during winching, keep others away. Alert all bystanders of an unstable condition.
- **Always** unspool as much rope as possible when rigging. Double line or pick distant anchor point.
- **Always** take time to use appropriate rigging techniques for a winch pull.
- **Never** touch winch rope or hook while someone else is at the control switch or during winching operation.
- **Never** engage or disengage clutch if winch is under load, winch rope is in tension or drum is moving.
- **Never** touch winch rope or hook while under tension or under load.
- **Always** stand clear of winch rope and load and keep others away while winching.
- **Never** use vehicle to pull load on winch rope. Combined load or shock load can damage, overload and break rope.
- **Never** wrap winch rope back onto itself. Use a choker chain or tree trunk protector on the anchor.

 WARNING	
	

FALLING OR CRUSHING HAZARD

Failure to observe these instructions could lead to serious injury or death.

- **Always** stand clear, keep hands clear, keep others away.
- **Never** operate winch with less than 10 wraps of rope around the drum. Rope could come loose from the drum, as the rope attachment to the drum is not designed to hold a load.
- **Never** use winch as a hoist or to suspend a load.
- **Always** be certain anchor will withstand load, use appropriate rigging and take time to rig correctly.
- **Never** use winch to lift or move persons.
- **Never** use excessive effort to freespool winch rope.
- **Always** use proper posture/lifting technique or get lifting assistance while handling and installing product.
- **Always** spool the rope onto the drum in the direction specified by the winch warning label on the winch and/or documentation. This is required for the automatic brake (if so equipped) to function properly.
- **Always** spool the winch rope onto the drum as indicated by the drum rotation label.

 WARNING	
	

CUT AND BURN HAZARD

Failure to observe these instructions could lead to serious injury or death.

To avoid injury to hands and fingers:

- **Always** wear heavy leather gloves when handling winch rope.
- **Always** be aware of possible hot surfaces at winch motor, drum or rope during or after winch use.

GENERAL SAFETY PRECAUTIONS

 WARNING	
	
	
CHEMICAL AND FIRE HAZARD	
<p>Failure to observe these instructions could lead to serious injury or death.</p> <ul style="list-style-type: none"> • Always remove jewelry and wear eye protection. • Never route electrical cables across sharp edges. • Never route electrical cables near parts that get hot. • Never route electrical cables through or near moving parts. • Always place the supplied terminal boots on wires and terminals as directed by the installation instructions. • Never lean over battery while making connections. • Never route electrical cables over battery terminals. • Never short battery terminals with metal objects. • Always verify area is clear of fuel lines, fuel tank, brake lines, electrical wires, etc., when drilling. • Always consult operator's manual for proper wiring details. • Always insulate and protect all exposed wiring and electrical terminals. 	

 WARNING
<p>IMPACT AND MOVING PARTS ENTANGLEMENT HAZARD</p> <p>Failure to observe these instructions could lead to serious injury or death.</p> <p>To avoid injury to hands and fingers:</p> <ul style="list-style-type: none"> • Always know the Working Load Limit (WLL) of your rope. • Never Exceed the WLL of 10,000 lbs. (4536 kg) or shock load this rope. • Always determine the suitability of a rope for a specific application. • Never use the included rope on a winch with a rated line pull greater than 10,000 lbs (4536 kg). • Never use a rope if worn, damaged, abused, overloaded, improperly maintained or over 1 year old. • Never stand within the recoil (snapback) area. • Never use rope over a rough surface without Chafe Protection. • Never bend rope around unprotected, sharp corners. • Always use WARN Hawse Fairlead P/N 87914. • Always replace rope every 12 months with P/N 87915. • Always replace the WARN Hawse Fairlead if damaged or abused with P/N 87914. • Never leave clutch disengaged when not freespooling rope. The automatic brake will not operate when clutch lever is in freespool.

GENERAL SAFETY PRECAUTIONS

 CAUTION	
	
CUT AND BURN HAZARD	
<p>Failure to observe these instructions could lead to minor or moderate injury.</p> <ul style="list-style-type: none"> • Never let winch rope slip through your hands. 	
 CAUTION	
	
MOVING PARTS ENTANGLEMENT HAZARD	
<p>Failure to observe these instructions could lead to minor or moderate injury.</p> <p>To avoid injury to hands or fingers:</p> <ul style="list-style-type: none"> • Never leave remote control where it can be activated during free spooling, rigging, or when the winch is not being used. • Never leave the winch remote control plugged in when installing, freespooling, rigging, servicing or when the winch is not being used. 	

NOTICE
<p>AVOID WINCH AND EQUIPMENT DAMAGE</p> <ul style="list-style-type: none"> • Always avoid side pulls which can pile up rope at one end of the drum. This can damage rope or winch. • Always ensure the clutch is fully engaged or disengaged. • Always use care to not damage the vehicle frame when anchoring to a vehicle during a winching operation. • Never submerge winch in water. • Always store the remote control in a protected, clean, dry area. • Always avoid continuous "Power-Out". Heat build up from continuous power out may damage the rope. • Never expose the rope to harsh detergents, fuels, oils, or Anti-freeze. • Always use a chafe protector on all sharp edges to protect rope. • Never allow the rope to contact sharp objects. Severe damage may result. • Always respool rope in even wraps following any angled winching activities. • Never "jog" rope under load. Shock loads can momentarily exceed capacity of rope and winch. • Never install more than 100' of 3/8" synthetic rope. Damage to the winch may result.

SAFE WORKING CONDITIONS

SAFE WORKING CONDITIONS

The operator should always operate the winch from a safe position when pulling a load. The safe areas are: (1) Perpendicular to the rope, (2) Inside the vehicle with the hood up (if winch is mounted on front of vehicle). These safe positions will help prevent the rope from striking the operator if the rope fails when under load.

Operate winch from the fully extended remote control cord length whenever possible. The operator must always be at least 8 ft. (2.44 m) from the winch while operating. This will prevent entanglement with the fairlead and keep the operator out of harms way during winch load pulling.

Never work around the rope while under load.

Sound Emissions

The winch is designed so that the sound emissions do not exceed 70 dBA from the operator's station. The operator must be at least 8 ft. (2.44 m) from the winch while operating. If the winch is exceeding 70 dBA from the operator's station, have the winch inspected at an authorized service center.

Cleaning

Use low pressure water to clean synthetic rope. Do not use any chemicals.

Do not direct high pressure water (pressure washers, car washes, etc.) between the drum support and drum flange or clutch lever.

Use low pressure water and a soapy rag or sponge to clean the winch.

Avoid using chemicals that may damage the finish.

Thoroughly clean salt residue from the winch as soon as possible to minimize corrosion.

Maintenance

Replace rope every 12 months with WARN rope P/N 87915.

No lubrication is required for the life of the winch unless the winch has been submerged in water. If this occurs, a qualified service center must complete service as soon as possible to prevent corrosion damage. If the control pack is submerged, it must be replaced when the winch is serviced.

Check battery cables and electrical connections at 90 day intervals to be certain they are clean and tight at all connection points.

Inspect the rope before and after each winching operation. When damaged, replace with the size specified in the Replacement Parts List, or go to the Warn website at www.warn.com.

The rope must always spool onto the drum as indicated by the drum rotation decal on the winch.

WARNING
Always stand clear, keep hands clear, keep others away.

WARNING
Always require operators and bystanders to be aware of vehicle and/or load.

CAUTION
Never leave remote control where it can be activated during free spooling, rigging, or when the winch is not being used.

NOTICE
Never submerge winch in water.

MOUNTING WINCH

WARNING
Always choose a mounting location that is sufficiently strong to withstand the maximum pulling capacity of your winch.

WARNING
Always complete the winch installation and attach the hook before installing the wiring.

WARNING
Never use bolts that are too long.

MOUNTING WINCH

Choose a mounting location that is sufficiently strong enough to withstand the loads you intend to winch. Only the mounting orientations shown are possible for safe winching operation. All others are improper and inappropriate. The use of recommended bolt and lock washer combinations torqued to recommended levels will prevent vibration during operation. The mounting details indicate the proper torque levels.

Remember the winch rope must always spool onto the drum as indicated by the drum rotation decal.

Refer to the following diagrams for proper mounting orientation.

Mounting Bolt Pattern:
10" X 4.5" (254 mm x 114.3 mm)

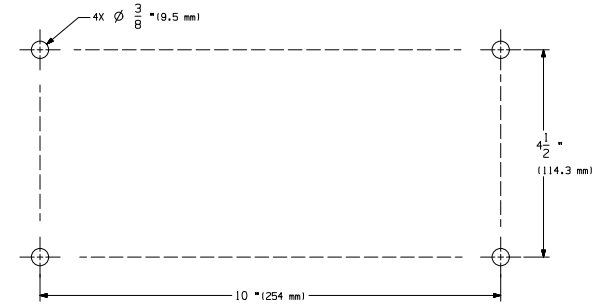

Control Pack Installation

Mount the control pack according to the instructions included in the WARN mounting system kit. Use the bracket included in the kit.

Plate Thickness	Bolt Length
1/4" (7 mm)	1.25" (32 mm)
3/8" (10 mm)	1.5" (40 mm)
1/2" (13 mm)	1.5" (40 mm)

Mounting Details:

- (1) Smooth and flat, thickness = 1/4" (6.4 mm)
- (2) 3/8" (9.525 mm) lockwasher X 4
- (3) 3/8-16 X 1 1/4" long, grade 5 bolt X 4
Torque 30-35 ft. lbs. (41-47Nm)
- (4) 1/2-13 Locknut
- (5) 1/2 Flat washer
- (6) 3/8-16 Sq. nut
- (7) 1/2-13x2" button head bolt
- (8) Aluminum Fairlead

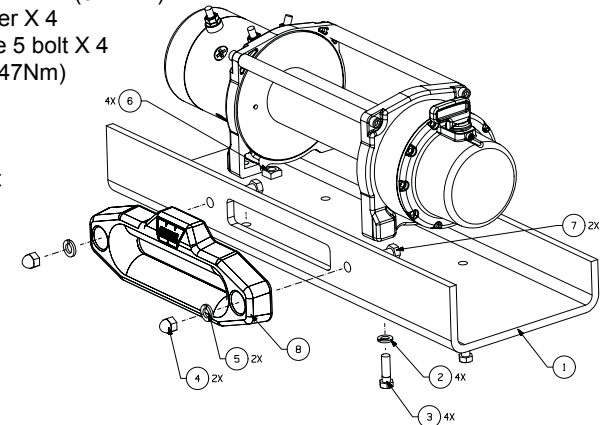

ELECTRICAL CONNECTIONS

Use the included insulating boots on exposed connections to prevent electrical shorting. Route battery connection cables in areas which will not cause them to chafe or cut through the insulation causing a potential short circuit.

Upon completion of installation, check winch for proper operation.

Electrical Diagrams:

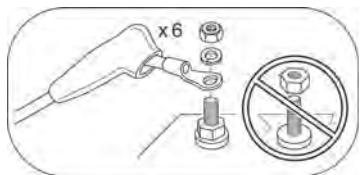

Battery Recommendations

A fully charged battery and good connections are essential to the proper operation of your winch. The minimum requirement for a 12 volt DC battery is 650 Cold Cranking Amps.

Pin #	Color
1	Brown
2	White
3	Black
4	Green
5	
6	Red

WARNING
Never route electrical cables across sharp edges.

WARNING
Never route electrical cables near parts that get hot.

WARNING
Never route electrical cables through or near moving parts.

WARNING
Always place the supplied terminal boots on wires and terminals as directed by the installation instructions.

WARNING
Always insulate and protect all exposed wiring and electrical terminals.

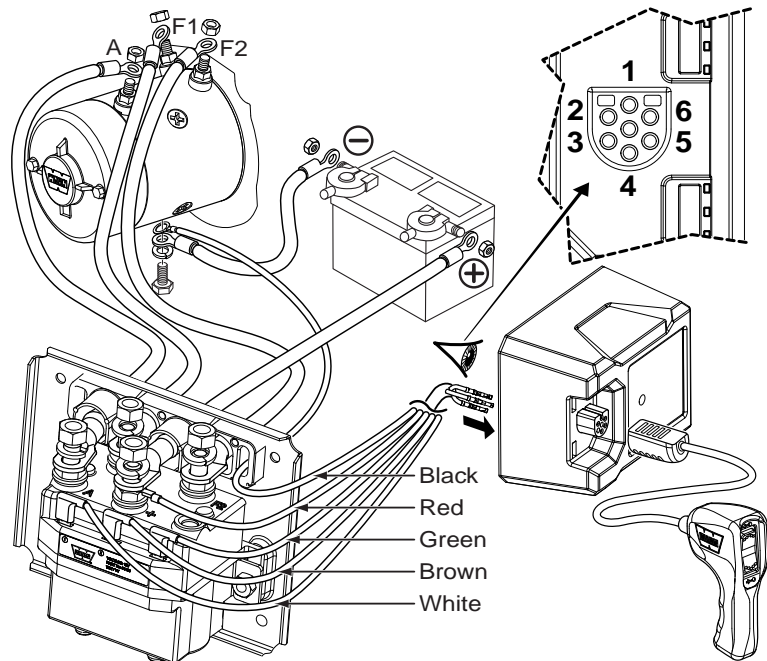

WARNING
Always take time to fully understand your winch and the winching operation by reviewing The Basic Guide to Winching Techniques included with your winch.

WARNING
Never engage or disengage clutch if winch is under load, winch rope is in tension or drum is moving.

WARNING
Never operate winch with less than 10 wraps of rope around the drum. Rope could come loose from the drum, as the rope attachment to the drum is not designed to hold a load.

NOTICE
Do Not power-out rope more than 30 ft. without allowing the winch to cool for 20 minutes before powering rope back in. Instead, place the clutch in freespool and pull the rope off by hand.

Remote Control Switch

Do not leave the remote plugged into the winch when not in use. Leaving the remote plugged in, may result in a dangerous condition and/or battery drain.

Vertical Remote:

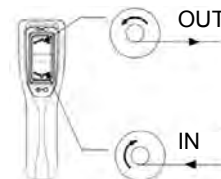

Clutch Operation

When the clutch is engaged, the gear train is coupled to the rope drum and power can be transferred from the winch motor. When the clutch is disengaged it is in the freespool position and the gear train and rope drum are uncoupled allowing the drum to rotate freely.

The clutch lever, located on the winch housing opposite the motor, controls the clutch position. To prevent damage, always fully engage or fully disengage the clutch lever.

Disengaged:

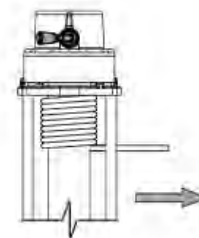

Engaged:

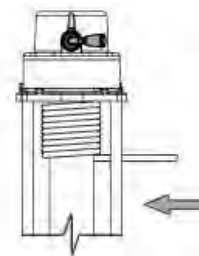

Spooling Out

Freespooling is generally the quickest and easiest way to spool out rope. Before freespooling rope out from the winch, power out enough rope to remove any tension the rope might be under. Disengage the clutch. Then freespool by manually spooling out enough rope for the winching operation. See *The Basic Guide to Winching Techniques* for more information.

Always leave at least 10 wraps of rope on the drum.

OPERATING INSTRUCTIONS

Cont.

Spooling In Under Load

Never exceed winch's rated line pull.

Power-in the rope evenly and tightly on the drum. This prevents the outer wraps from sinking into the inner wraps, binding, and damaging the rope.

Avoid shock loads when spooling, by pulsing the control switch to take up rope slack. Shock loads can momentarily far exceed the winch and rope ratings.

Spooling In Under No Load

Spooling with an Assistant: Have the assistant hold the hook strap putting as much constant tension on the rope as possible. While keeping tension, the assistant should walk toward the winch while you operate the control switch spooling in the rope. Release the switch when the hook is a minimum of 6 ft. (2 m) from the fairlead opening.

Spool in the remainder for storage as directed below.

Spooling Alone: Arrange the rope to be spooled so it will not kink or tangle when spooled. Be sure any rope on the drum is tightly and evenly layered. Spool enough rope to complete the next full layer on the drum. Tighten and straighten the layer. Repeat process until the hook is a minimum of 6 ft. (2 m)

from the fairlead opening.

Spool in the remainder for storage as directed below.

Spooling Remainder for Storage

When the hook is within 6 ft. (2 m) of the fairlead, disconnect the hook from the anchor or load. Hold onto the supplied hook strap and hold tension on the winch rope. Slowly power-in the winch by "pulsing" the power-in switch on the remote control until the hook is within 3 ft. (1 m) of the fairlead. Stop winching in and attach the hook to a suitable anchor point on the vehicle.

DO NOT POWER THE HOOK INTO THE FAIRLEAD. This could cause damage to the fairlead. Once the hook is suitably attached to the vehicle, power-in the remaining slack in the winch rope by "pulsing" the power-in switch on the remote control until there is minimal slack in the winch rope.

Overloading/Overheating

This winch is rated for intermittent duty. When the motor approaches stall speed, very rapid heat buildup occurs which may cause motor damage.

Double-line rigging (see *The Basic Guide to Winching Techniques*) will reduce the amperage draw, and reduce heat buildup in the motor. This allows longer continual use.

WARNING
Always keep hands clear of winch rope, hook loop, hook and fairlead opening during installation, operation, and when spooling in or out.

WARNING
Never touch winch rope or hook while someone else is at the control switch or during winching operation.

WARNING
Always wear heavy leather gloves when handling winch rope.

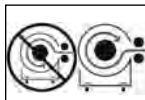

WARNING
Always use supplied hook strap whenever spooling winch rope in or out, during installation or operation to avoid injury to hands and fingers.

WARNING
Always prestretch rope and respool under load before use. Tightly wound rope reduces chances of "binding", which can damage the rope.

WARNING
Never touch rope or hook while someone else is at the control switch or during winching operation.

Spooling

THE FOLLOWING STEPS ARE VERY IMPORTANT AND IF NOT PRECISELY FOLLOWED THE LIFE OF THE WINCH AND ROPE MAY BE COMPROMISED.

1. Mount the Warn Aluminum Hawse Fairlead to the winch mount using the supplied hardware. Always mount the fairlead with the labels in the upright position (labels on top and clearly visible). Insert a 7/16" x 1 1/4" bolt through each of the two fairlead mounting holes and through the winch mount. Place a 7/16" f at washer onto each bolt. Install a 7/16" lock nut onto each bolt and tighten to 35 ft. lbs.

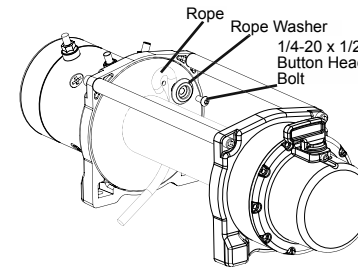

2. Slide the abrasion sleeve over the rope from the end opposite the hook. Slide the sleeve back to the hook end of the rope.

3. Apply Lock Tite 271 or equivalent product to the supplied 1/4"-20 x 1/2" long button head fastener.

4. Install the new synthetic rope using the button head fastener supplied and the machined rope washer. Insert the synthetic rope through the aluminum fairlead and around the winch drum from the bottom. Insert the button head bolt into the machined rope washer and place the synthetic rope on the machined rope washer. Install the button head bolt in the 1/4-20 hole in the side of the winch drum. See Figure for detail.

NOTICE
Never install more than 100' of 3/8" synthetic rope. Damage to the winch may result.

5. Tighten the 1/4-20 button head bolt to 8 ft. lbs. Turn the winch clutch level to the "engaged" position.

6. It is now necessary to spool the remaining rope onto the winch drum. Choose a FLAT location that is large enough to run out the entire length of rope. Attach the hook end of the rope to a suitable anchor point and back the vehicle away from the anchor point leaving approximately 6 ft of slack rope lying on the ground. Before getting out of the vehicle, set the parking brake, place the vehicle in gear or park and turn the vehicle off.

7. Connect the remote control to the winch. Standing approximately 8 ft away from the winch, power in the winch until there is 10 wraps onto the winch drum. Disconnect the remote control from the winch. Hold tension on the rope with one hand; carefully push the rope to the side of the drum the rope is attached to so there are no gaps between each coil on the drum. Be sure to check that the rope is winding off of the bottom of the drum, not the top, or the automatic load holding brake will not function properly. (If the rope is winding off the top you have powered the winch "out" instead of "in" on the remote control)

8. If there is still rope laying on the ground, back the vehicle away until the rope is off of the ground.

9. The following steps should be done using two people for proper safety. If you attempt to tension your rope alone be sure to always engage the parking brake, place the transmission in gear and turn the vehicle off every time you exit the vehicle to inspect the winch rope. Never exit the vehicle with a load on the winch rope. Tensioning

INSTALLING THE ROPE Cont.

the rope is critical to ensure a long product life. Tensioning the rope prevents the rope from sinking into the lower layers under load.

10. Use care to evenly wrap each layer to prevent damage to the rope.

11. Pass the remote control through the driver's window for the driver of the vehicle to operate. Instruct your assistant to stand to the side of the vehicle and away from the winch rope. Your assistant should signal you if the rope is winding correctly by watching it move across the fairlead as the rope is powered in. Start the vehicle and place the transmission in neutral. Release the parking brake while applying moderate brake pedal pressure. Power the winch remote in. After winching in for approximately 6 ft, stop winching. Slowly let up off of the brake pedal and then apply the parking brake. This will ensure that there is no load on the winch rope. Then place the transmission in park or gear and turn the vehicle off. Exit the vehicle and inspect the winch rope is being evenly wound onto the winch drum and not sinking into the lower layer. If the rope is sinking, power the rope out and repeat this step from the beginning with more brake pedal pressure.

12. Once you are convinced the rope is winding on the winch properly, return to the vehicle. Pass the remote control through the driver's window for the driver of the vehicle to operate. Start the vehicle and place the transmission in neutral. Release the parking brake while applying moderate brake pedal pressure. Power the winch

remote in. After winching in for approximately 6 ft, stop winching. Slowly let up off of the brake pedal and then apply the parking brake. This will ensure that there is no load on the winch rope. Then place the transmission in park or gear and turn the vehicle off. Exit the vehicle and inspect the winch rope is being evenly wound onto the winch drum and not sinking into the lower layer. If the rope is sinking, power the rope out and repeat this step from the beginning with more brake pedal pressure.

13. Repeat step 12 until the vehicle is within 6 ft of the winch anchor. Once within 6 ft, slowly let up off of the brake pedal and then apply the parking brake. This will ensure that there is no load on the winch rope. Then place the transmission in park or gear and turn the vehicle off. Exit the vehicle. Disconnect the hook from the anchor. While holding onto the supplied hook strap, hold tension on the winch rope and slowly power-in the winch by "pulsing" the power-in on the remote control until the hook is within 3 ft. of the fairlead. Stop winching in and attach the hook to a suitable anchor point on the vehicle. **DO NOT POWER THE HOOK INTO THE FAIRLEAD.** This would cause irreparable damage to the fairlead. Once the hook is suitably attached to the vehicle, power in the remaining slack in the winch rope by "pulsing" the power-in on the remote until there is minimal slack in the winch rope.

⚠ WARNING
Always spool the rope onto the drum in the direction specified by the winch warning label on the winch and/or documentation. This is required for the automatic brake (if so equipped) to function properly.

⚠ WARNING
Always use supplied hook strap whenever spooling winch rope in or out, during installation and during operation.

⚠ WARNING
Never operate winch with less than 10 wraps of rope around the drum. Rope could come loose from the drum, as the rope attachment to the drum is not designed to hold a load.

⚠ WARNING
Never operate winch with less than 10 wraps of rope around the drum. Rope could come loose from the drum, as the rope attachment to the drum is not designed to hold a load.

ROPE INSPECTION

When rope is first used, the outer filaments of the rope will quickly fuzz up. This is the result of these filaments breaking and this roughened surface will actually protect the fibers underneath. The condition should stabilize, not progress. If the surface roughness increases, excessive abrasion is taking place and strength is being lost. Look closely at both the inner and outer fibers. When either is worn the rope is obviously weakened. Open the strands and look for powdered fiber—this is a sign of internal wear.

Rope should be replaced when:

- Rope bulk anywhere along the length is reduced by 10% or more by abrasion.
- Two or more adjacent strands are cut.
- Flat areas or lumps are found that are not eliminated by fixing rope.
- Excessive fused or melted fibers are found. Any such areas will be stiff and the rope will have a glazed appearance.

Rope Storage and Care

To ensure safety and performance, the inspection and maintenance of winching rope should be among every user's primary concerns.

1. Inspect your winch rope for breaks, cuts, abrasion and melted or fused fibers before each use.
2. Wash rope periodically to

remove dirt and grit. Simply rinse rope with a garden hose, and allow it to air-dry.

DO NOT use solvents, bleach or harsh detergents when washing rope, and never apply a heat source to speed drying.

3. Coil rope loosely, for storage, being sure to remove any excess twists. To maximize rope life, always store rope line in a dark, dry place. Before using any rope, refer to the following guide. If the rope is damaged, remove it from service immediately, and replace it with undamaged rope, WARN P/N 87915. Broken or cut strands reduce the rope's strength throughout its length — not just in the area of damage. As a general rule, retire your 12 strand rope when more than 3 broken or cut strands are visible, or if two adjacent strands are compromised.

4. Replace your rope every 12 months with only WARN rope, P/N 87915.

Normal Wear

When small surface fibers break on a rope, they create a fuzzy texture. Known as "mild abrasion," this is considered good wear, and will not affect the performance of the rope. The nubby surface actually protects the underlying fiber from further wear.

Excessive Wear—RETIRE THE ROPE

When fibers are melted or fused, it is generally the result

ROPE INSPECTION

ROPE INSPECTION Cont.

of rope abuse. Melted or fused polyester fibers result from bringing the rope's surface to a temperature in excess of 430° F. Caused by excessive load weights or powering out, these damaged fibers can compromise strength, and should signal the rope's retirement.

Chemical Attack—RETIRE THE ROPE (NOT ILLUSTRATED)

Localized discolorations could potentially represent chemical attack by anything from gear oil to battery acid. When doubt exists, retire the line.

 WARNING
Always wear heavy leather gloves when handling winch rope.

Examples:



Rope with original bulk.



Rope displaying 25% strand volume reduction from abrasion—**rope should be replaced.**



Rope strand showing full volume.



Rope strand reduced by 25% abrasion—**rope should be replaced.**



Rope exhibits fiber-set from compression. A slight sheen is visible. This is not a permanent characteristic and can be eliminated by flexing the rope.



Rope displays two adjacent cut strands—**rope should be replaced.**