



# INSTALLATION INSTRUCTIONS

## ELITE FRONT BUMPER

Part Number: 87750 w/ Grille Guard & 87775 w/o Grille Guard

Application: Jeep JK 2007+

### GENERAL SAFETY PRECAUTIONS

Your safety, and the safety of others, is very important. To help you make informed decisions about safety, we have provided installation and operating instructions and other information on labels and in this guide. This information alerts you to potential hazards that could hurt you or others. It is not possible to warn you about all potential hazards associated with this product, you must use your own good judgment.

**CARELESS INSTALLATION AND OPERATION CAN RESULT IN SERIOUS INJURY OR EQUIPMENT DAMAGE. READ AND UNDERSTAND ALL SAFETY PRECAUTIONS AND OPERATING INSTRUCTIONS BEFORE INSTALLING AND OPERATING THIS PRODUCT.**

This guide identifies potential hazards and has important safety messages that help you and others avoid personal injury or death. **WARNING** and **CAUTION** are signal words that identify the level of hazard. These signal words mean:

▲ **WARNING** signals a hazard that could cause serious injury or death, if you do not follow recommendations. ▲ **CAUTION** signals a hazard that may cause minor to moderate injury, if you do not follow recommendations.

This guide uses **NOTICE** to call attention to important mechanical information, and **Note:** to emphasize general information worthy of special attention.

### ▲ WARNING

Impact and Moving Parts Entanglement Hazard

#### **FAILURE TO OBSERVE THESE INSTRUCTIONS COULD LEAD TO SEVERE INJURY OR DEATH**

- Always use extreme caution when drilling on any vehicle. Make sure that all fuel lines, brake lines, electrical wires, and other objects are not punctured or damaged when / if drilling on the vehicle. Thoroughly inspect the area to be drilled (on both sides of material) prior to drilling, and relocate any objects that may be damaged. Failure to inspect the area to be drilled may result in vehicle damage, electrical shock, fire or personal injury.
- Always wear safety glasses when installing this kit. A drilling operation will cause flying metal chips. Flying chips can cause eye injury.
- Always use extreme caution when cutting and trimming during fitting.
- Always remove jewelry and wear eye protection.
- Never lean over battery while making connections.
- Always use appropriate and adequate care in lifting components into place.
- Always insure components will remain secure during installation and operation.
- Always tighten all nuts and bolts securely, per the installation and operation.
- Always perform regular inspections and maintenance on the winch, winch mount and related hardware.
- Always replace all worn or damaged parts before operating.
- Never operate this WARN product with damaged or missing parts.
- Never work under vehicle before properly securing vehicle.

Read installation and operating instructions thoroughly.

WARN INDUSTRIES, INC. 12900 S.E. Capps Road,  
 Clackamas, OR USA 97015-8903, 1-503-722-1200, FAX: 1-503-722-3000  
**Customer Service:** 1-800-543-9276  
**Dealer Locator Service:** 1-800-910-1122  
**International Sales/ Customer Service:** 1-503-722-3008  
**International Fax:** 1-503-722-3005

## **⚠ CAUTION**

### **Moving Parts Entanglement Hazard**

#### **FAILURE TO OBSERVE THESE INSTRUCTIONS COULD LEAD TO MINOR OR MODERATE INJURY**

- **Always take time to fully read and understand the installation and Operations Guide included with this product.**
- **Part edges may be sharp!**

Read installation and operating instructions thoroughly.

## **NOTICE**

### **Equipment Damage**

- **Always refer to the Installation and Specification Guide, supplied in the winch kit, for all wiring schematics and specific details on how to wire this WARN product to your vehicle.**

Read installation and operating instructions thoroughly.

## **NOTES**

The Warn Elite Bumper for the Jeep JK will accept a large range of mid frame winches with up to 12,000 lb. capacities. The Bumper has been designed to accommodate the standard 4-1/2 x 10" feet down mounting pattern as well as the 4-1/2 x 6" short drum pattern. The Warn PowerPlant HP and HD can be installed using the offset mounting holes and included Offset Fairlead Plate.

## **BEFORE YOU BEGIN**

- The Elite Bumper is designed to accept a wide variety of mid frame winches. Standard 4-1/2" x 10", 4-1/2" x 6" short drum and 4-1/2" x 10" offset mounting holes are available. Some winches mounted in some locations may require sheet metal trimming. The Warn PowerPlant must be mounted in the offset position and will require trimming of the top of the Jeep bumper mounting plate. The Warn 9.5ti and 9.5cti mounted in the center position will require trimming of the plate but will require no trimming in the offset position. The Warn ZEON must be mounted in the center position and will require trimming of both mounting plates.
- Models equipped with factory fog lamps will need to have the wires lengthened before installing in the outboard locations in the Elite Bumper. Additional wire and connectors are included in this kit as well as special brackets for installing factory fog lamps.
- 2012 Jeep JK's are equipped with a canister mounted to the inside of the driver side frame rail, behind the bumper. This must be relocated and the metal bracket trimmed before bumper installation. Instructions on how to do this are included.
- The Elite Bumper is not compatible with the factory skid plate. It will not be reinstalled after installation of the WARN Elite Bumper

## **TABLE OF CONTENTS**

Tools Required.....	page 2
Torque Specifications.....	page 2
Parts List.....	page 3
Installation.....	page 4-9

## **TOOLS REQUIRED**

- Ratchet, extensions, universal
- Sockets: 10mm, 18mm, 7/16", 5/8", 11/16", 15/16"
- End Wrenches: 10mm, 3/16", 7/16", 5/8", 11/16"
- Phillips Screwdriver, metal cutting saw

## **TORQUE SPECIFICATIONS**

1/4	8 lb. ft. (10.8 N-m)
5/16	17 lb. ft. (12.5 N-m)
3/8	30 lb. ft. (40.7 N-m)
7/16	50 lb. ft. (67.8 N-m)
1/2	75 lb. ft. (101.7 N-m)

## PARTS LIST

Description	Qty	P/N
Elite Bumper w/Grille Guard	1	87530
Elite Bumper w/o Grille Guard	1	87611
Support Bracket	2	87371
Canister Relocation Bracket	1	90756
Factory Fog Lamp Bracket	2	87532
Light Mount Bracket	2	87531
Fog Lamp Bezel, LH	1	87528
Fog Lamp Bezel, RH	1	87529
Fairlead Plate, Std	1	87526
Fairlead Plate, Offset	1	87527
Hardware Kit	1	87927
Harness Extension Kit	1	87928
Light Insert Tube	2	87998

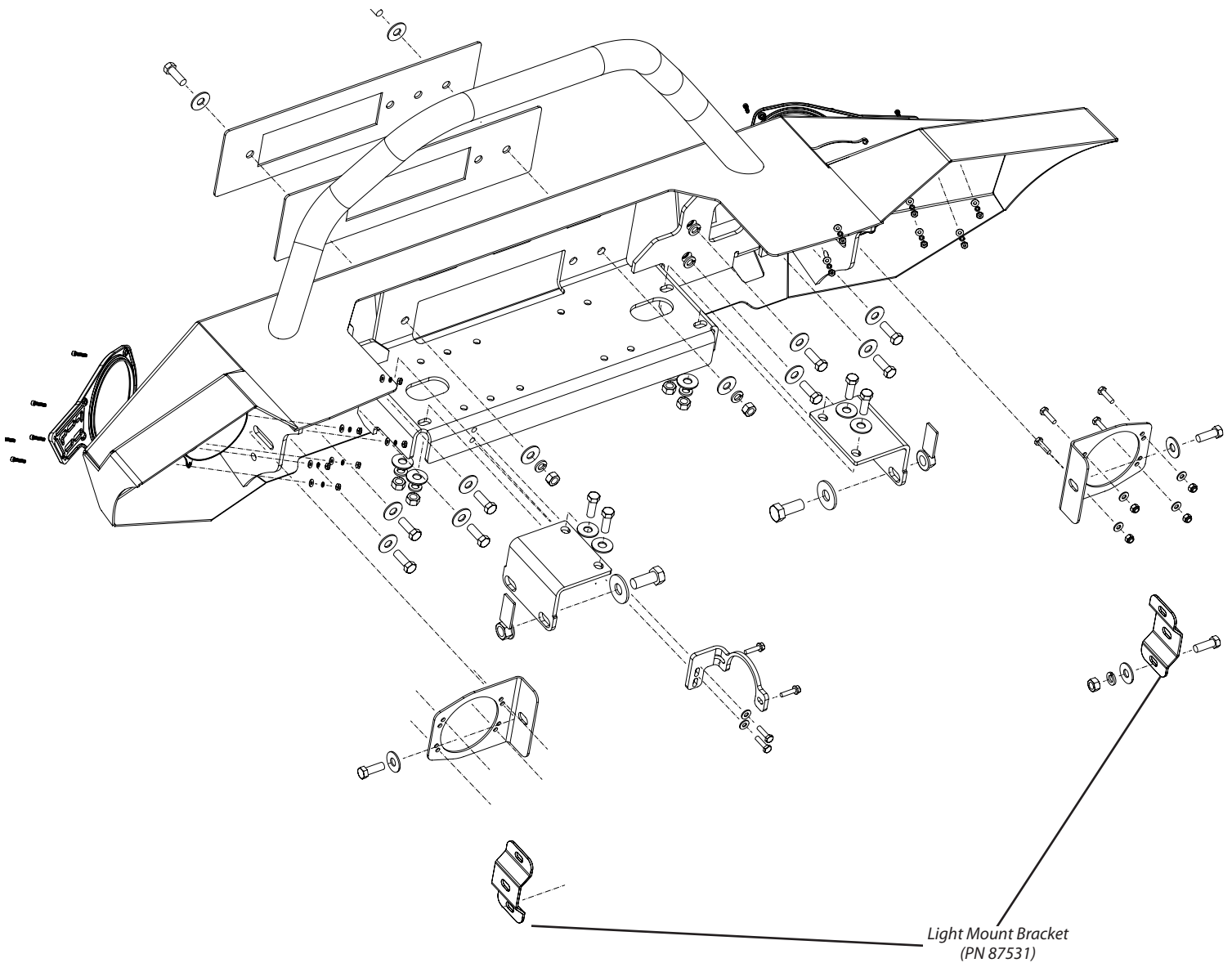

# INSTALLATION INSTRUCTIONS

## FOG LAMP BEZEL AND LIGHT INSERT TUBE INSTALLATION

The view shown is the back of the driver's side of the bumper. In this illustration, you are shown the light insert tube location. It is attached with the same hardware that attaches the left and right hand fog lamp bezels and places the metal bumper face between the two. The same light insert tube fits both the left and right hand side of the bumper. Notice the (L) and the (R) embossed in the plastic on insert tube. Attach the plastic insert tube using the hole nearest the (L) at the location shown at the same time you are installing the fog lamp bezel. Repeat the installation on the passenger side of the bumper using the hole next to the letter (R).

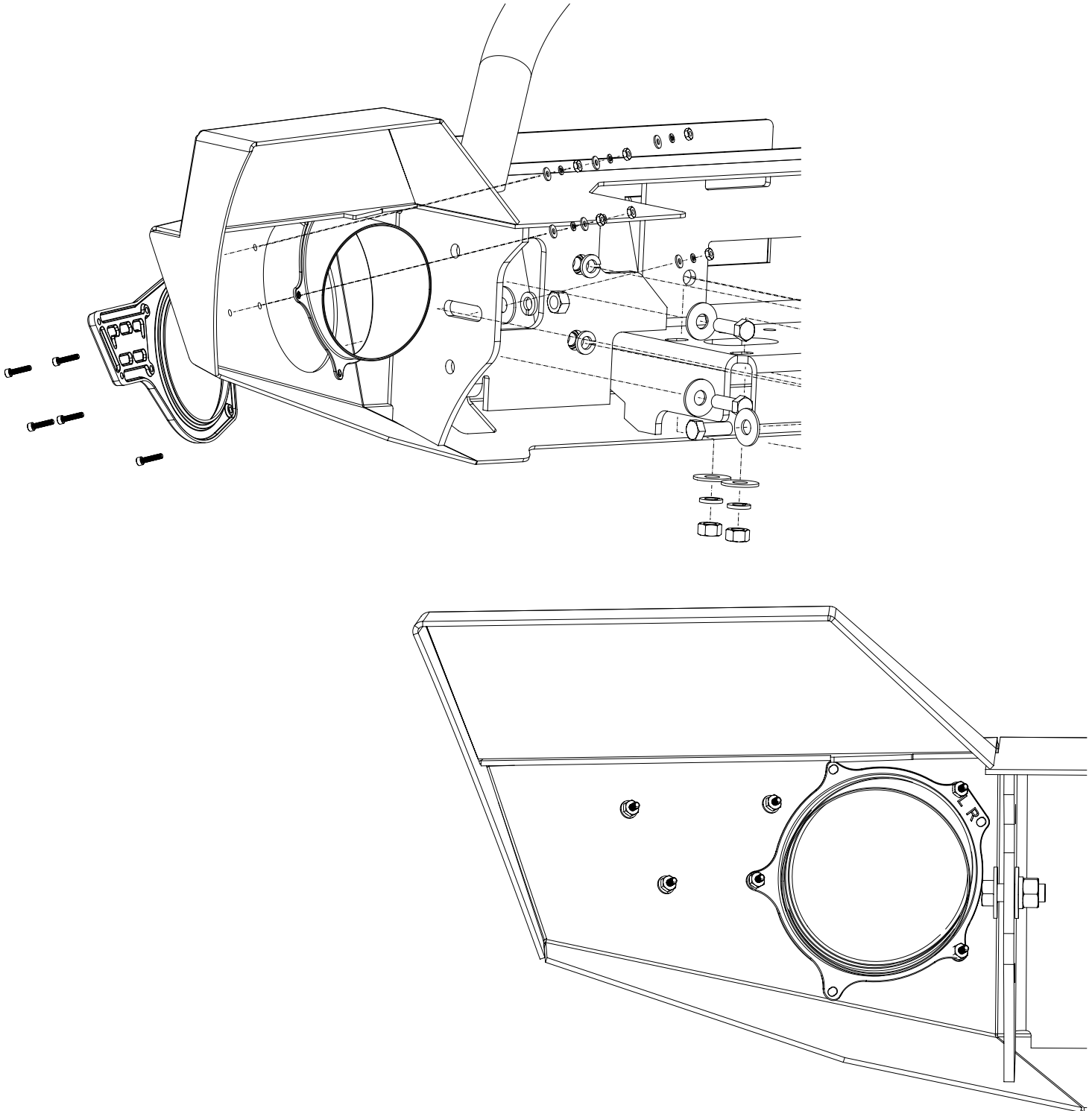

## INSTALLATION INSTRUCTIONS

1. Remove skid plate by removing 6 plastic Phillips head fasteners, 4 across the bottom of the bumper and 1 behind each end of the blocker beam. Figures 2 and 3.

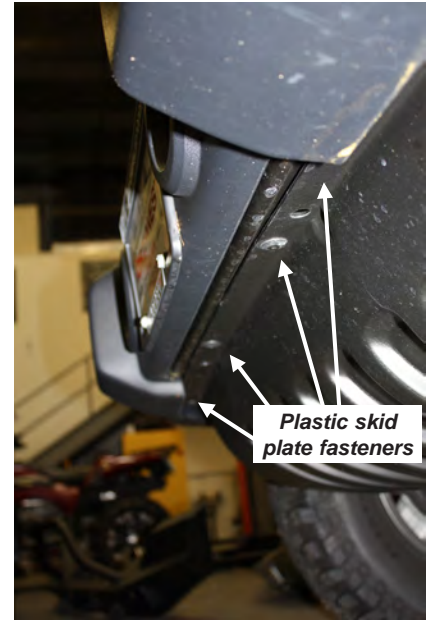

Figure 2

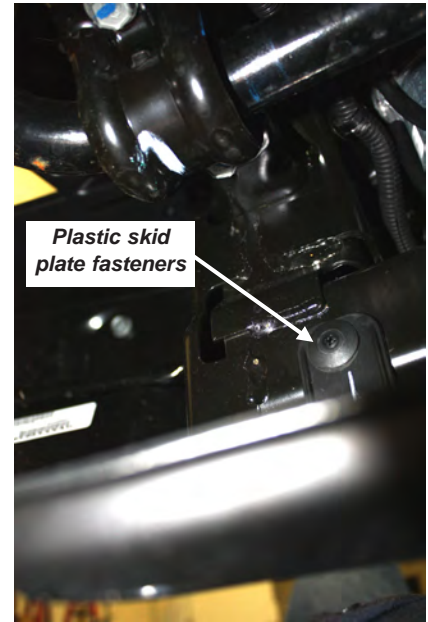

Figure 3

2. Unplug the factory fog lamps if equipped. Detach the wire harness from the bumper. Figure 4.

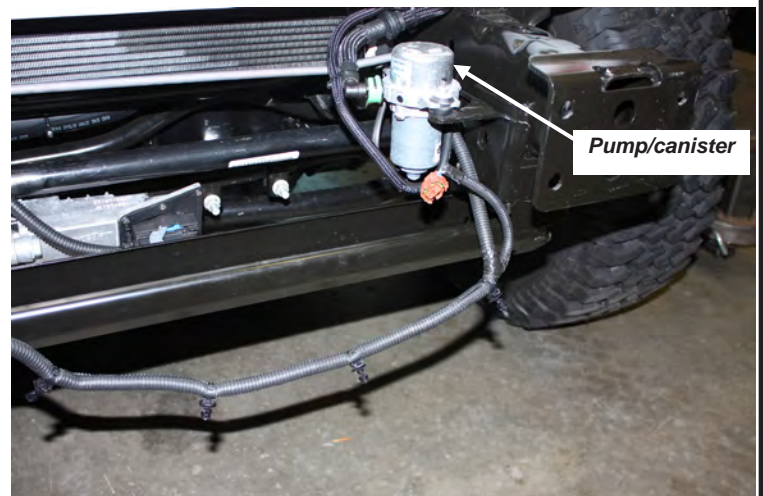

Figure 4

## INSTALLATION INSTRUCTIONS

3. Remove the 8 nuts (4 each side) that secure the bumper to the frame ends. Access from behind the bumper.
4. Remove the trim panel from the top of the frame by removing the 2 plastic fasteners.
5. Extend the fog lamp harness wires. The fog lamp locations in the Elite Bumper are farther apart than the factory locations. The harness must be lengthened to reach the openings. Only the driver side harness needs to be extended. Cut both fog lamp wires 4-6" in from the plug on driver side. Strip  $\frac{1}{4}$ " of insulation from each wire, both at the harness end and the plug end. Use the supplied wires and crimp type butt connectors to extend the fog lamp harness. Cover the extension with the corrugated wire loom provided.

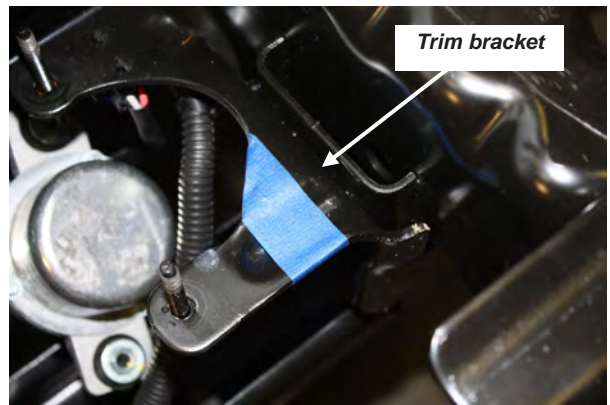

Figure 5



Figure 6

**NOTE:** If vehicle is not equipped with a vacuum canister mounted to the inside of the driver side frame rail (2012 model year), skip steps 6-8.

6. Remove the canister from the inside of the driver side frame rail if equipped. Remove the 2 nuts and lift the canister over the studs. Trim the canister bracket as shown in Figure 5. Use a hacksaw or reciprocating saw with metal blade. Be careful not to damage any lines or wires. Touch up raw edge with paint to prevent rust. Figure 6.
7. Carefully disconnect the hoses and electrical connection. Be careful not to strain or kink the lines, wires, or fittings. Figure 7.
8. Use a grinder or file to enlarge the slot in the factory canister bracket to match the frame hole behind it, about  $\frac{5}{8}$ " diameter. Figure 8. Touch up raw edge with paint to prevent rust. Figure 9.



Figure 7

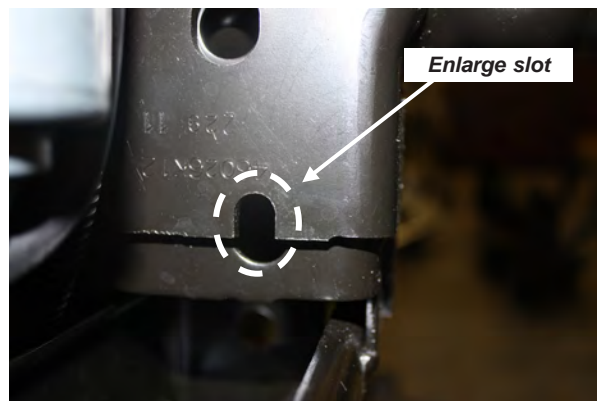

Figure 8

# INSTALLATION INSTRUCTIONS

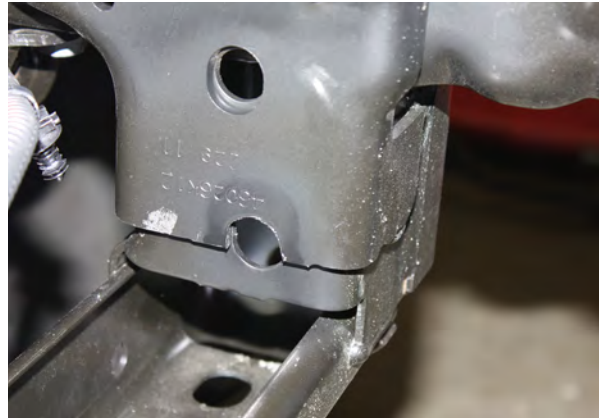

Figure 9

9. If you are installing a PowerPlant, 9.5ti or 9.5cti trim the top flange of the passenger side bumper mount. Figure 10.

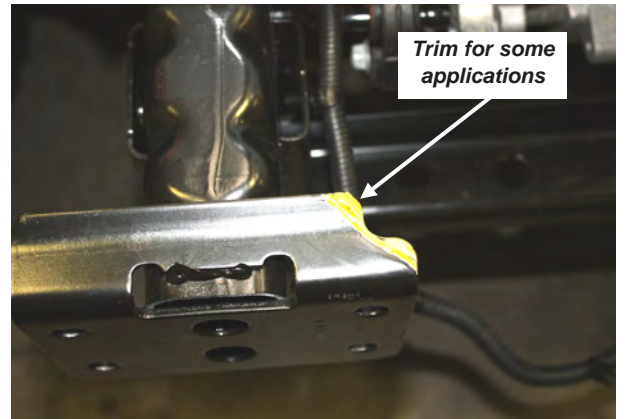

Figure 10

If you are installing a ZEON trim the top flange of the driver and passenger side bumper mounts. Figure 11 and 12.



Figure 11



Figure 12

## INSTALLATION INSTRUCTIONS

10. Install the Frame Brackets. The brackets are the same. Use 5/8 X 1-1/2" bolts and flat washers through the rear slot. Use the 5/8" nut plates inside the frame. Figure 13. Position them as shown in Figures 14. Do not tighten yet.

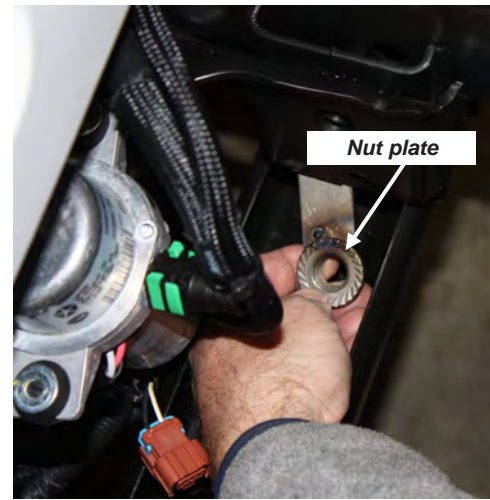

Figure 13

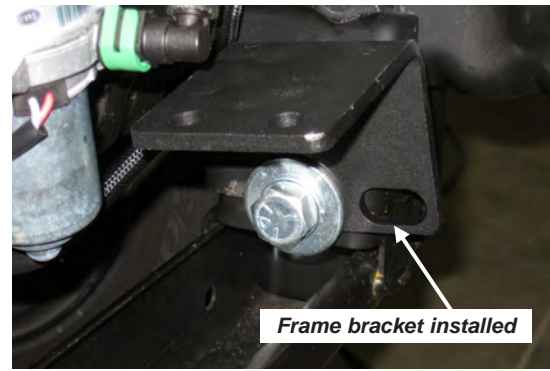

Figure 14

11. Attach the Canister Relocation Bracket to the rear of the Bumper as shown in Figure 15. Use 1/4-20 x 1" capscrews, flat washers and lock nuts. Do not tighten yet.

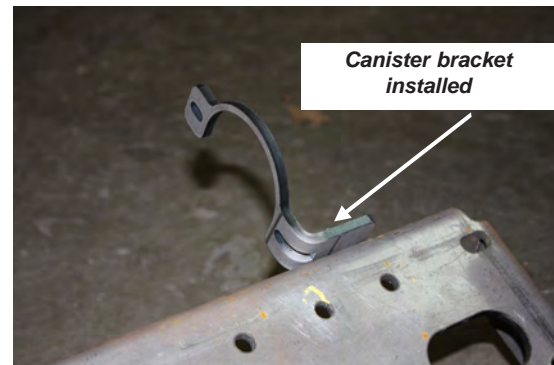

Figure 15

12. Install the bumper using 8 each (4 per side) 7/16 x 1-1/4" capscrews with flat washers and lock washers through the back of the frame pads into the bumper. Install 2 ( 1 per side) 7/16 nuts and washers on the top-outside bolts. Figure 16.



Figure 16



## INSTALLATION INSTRUCTIONS

13. Attach the Frame Brackets to the Bumper with 2 each 7/16 x 1-1/4" capscrews and flat washers, lock washers and hex nuts per side. Do not tight yet. Figure 17.
14. Attach the vacuum canister to the Relocation Bracket with the (2) 6mm capscrews and flat washers provided. Use the factor 6mm flange nuts to secure it. Make sure the canister, hoses, fittings and wires are not strained, kinked, pinched or rubbing against any moving parts. Use wire ties as needed. Figure 17.
15. Tighten the hardware to the correct specifications. Tighten the 8 Bumper mounting bolts, the 4 Frame Bracket to Bumper bolts then the 5/8" Frame Bracket to Frame bolts. Next, tighten the Canister Relocation Bracket then the canister (if equipped).



Figure 17

16. Install the fairlead plate. Use the centered plate if the winch will be mounted using the centered hole patterns. Use the offset plate if the winch will be mounted using the offset hole pattern. **DO NOT MIX THE PLATES.** Using the incorrect plate can damage the winch and/or winch rope. Figure 18.

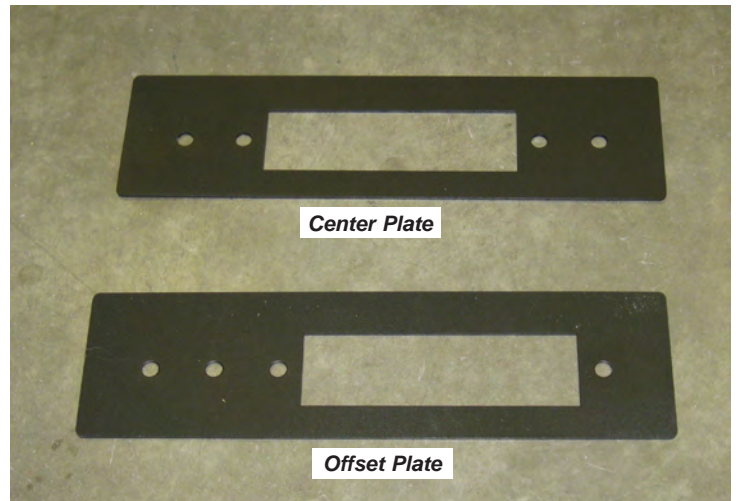

Figure 18

- a. Install the fairlead, use the 7/16 x 1-1/4 capscrews, flat washers, lock washers and nuts to secure the fairlead plate. Install the capscrews from the rear to avoid interference with the winch. Use the hardware that came with the fairlead to attach the fairlead.
17. Install the winch. Select the best mounting hole pattern. .  
NOTE: The motor ground cable may need to be rotated at the motor to avoid interfering with the frame bracket bolts. Figure 20. Use the hardware supplied with the winch. Tighten to the torque specification supplied with the winch.



Figure 19

18. Two holes are provided in the Bumper face for license plate installation.
19. Remove the factory fog lamps from the factory bumper by removing the 4 Phillips screws around each lamp. Figure 20.

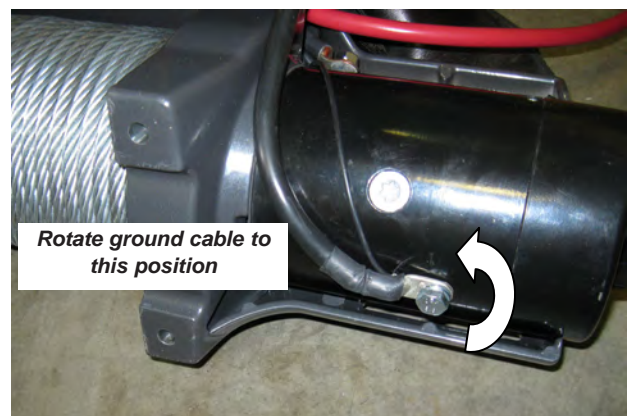

Figure 20

20. Enlarge each fog lamp mounting hole to 1/4".

21. Attach the fog lamps to the Fog Lamp Brackets using the 1/4-20 x 1" capscrews, flat washers and lock nuts. Make sure the fog lamp vents are on top. Figure 21.

22. Install the left and right Fog Lamp Bezels. Use 6 each 8-32 x 1 hex socket screws for each bezel. Install flat washers and lock nuts on the back of the bumper and tighten. These fasteners need only to be snug. Do not over tighten.

23. Install the fog lamps and Brackets. Use 7/16 x 1-1/2" capscrews, flat washers, lock washers and nuts. Adjust lamps and tighten. Figure 21.

24. Reconnect the fog lamp wires to the lamps. Secure the fog lamp wires with wire ties.

**NOTE** *Non-Factory Auxiliary Lights: Many 4" or smaller after-market fog and driving lamps can be used in the light ports if they can be mounted with the stem to the side. Check with the manufacture of the light to make sure they can be used in this way. Mount directly to the slots in the bumper gussets. If the light stems are too short use the supplied Light Mount Brackets. If you use the Light Mount Brackets use 7/16 x 1-1/4 capscrews, nuts and flat and lock washers for the bracket. WARN has a number of auxiliary light options that work in this application. Call Warn Customer Service or check online for a list of current available models.*



Figure 21



Figure 22



Figure 23

**CARELESS INSTALLATION AND OPERATION CAN RESULT IN SERIOUS INJURY OR EQUIPMENT DAMAGE. READ AND UNDERSTAND ALL SAFETY PRECAUTIONS AND OPERATING INSTRUCTIONS BEFORE INSTALLING AND OPERATING THIS PRODUCT.**

