

### Parts List

1	Grille guard
1	Driver / left frame mounting bracket
1	Passenger / right frame mounting bracket
1	Driver / left support bracket
1	Passenger / right support bracket
1	LED support flange
4	Hex bolt, 8mm
6	Flat washer, 8mm
2	Lock washer, 8mm
2	Clip nut, 8mm
2	Nylock nut, 8mm
4	Hex bolt, 10mm x 30mm
2	Hex bolt, 10mm x 80mm
10	Flat washer, 10mm
2	Lock washer, 10mm
4	Nylock nut, 10mm
2	Double bolt plate, 12mm
4	Flat washer, 12mm
4	Nylock nut, 12mm
4	Spacer

### Tools Required

Ratchet	Socket, 17mm
Socket, 13mm	Socket, 19mm
Utility knife	Allen wrench, 6mm

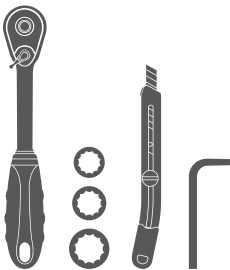

### Level of Difficulty

Easy



Scan for helpful install tips

### Product Image



### Notes and Maintenance

Before you begin installation, read all instructions thoroughly.

Proper tools will improve the quality of installation and reduce the time required.

For black finishes, mild soap may be used to clean the product.

### Step 1

Select an LED light, mounting hardware and brackets (sold separately). Attach the hardware to the support flange.

**Note:** LED manufacturers may have different mounting styles or brackets. Once the mounting option is determined, attach it to the support flange.



### Step 2

With the LED light attached to the support flange, place a clip nut on both ends of the support flange.

Insert an 8mm hex bolt, lock washer and flat washer into the clip nut. Leave enough space between the flat washer and clip nut to slot the support flange into the light bar cage on the grille guard.



### Step 3

Place the grille guard face down on a flat, stable work surface.

Insert the support flange into the light bar cage on the grille guard and ensure the flat washer, lock washer and head of the hex bolt are on the outside of the center flange.

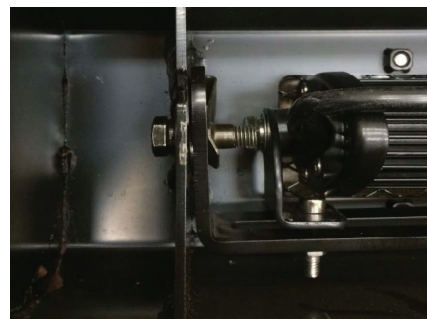

### Step 4

Remove the skid plate from the underside of the vehicle and remove the hardware securing the lower portion of the bumper cover.

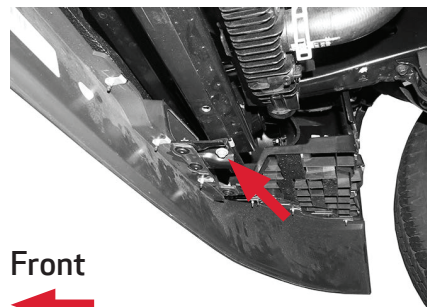
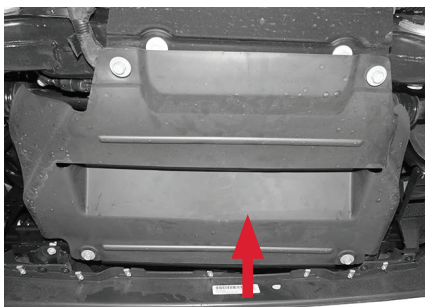

### Step 5

Remove the plastic fill panel on both the driver and passenger sides of the vehicle. Remove the front portion of the fender liner.

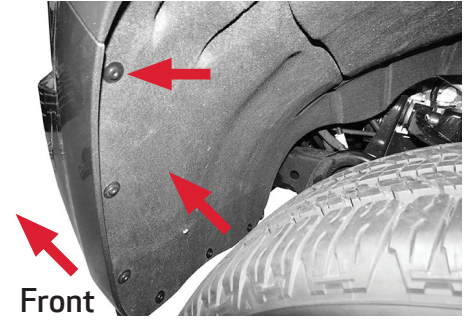
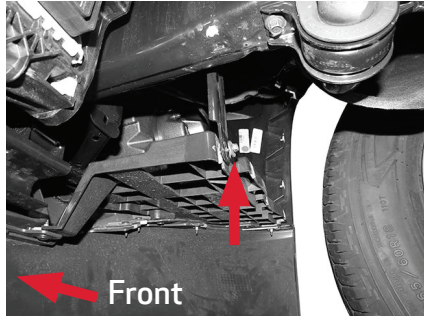

### Step 6

Pull back the fender liner and unplug any lights attached to the front bumper.

Finish removing the hardware attaching the bumper cover to the fender.

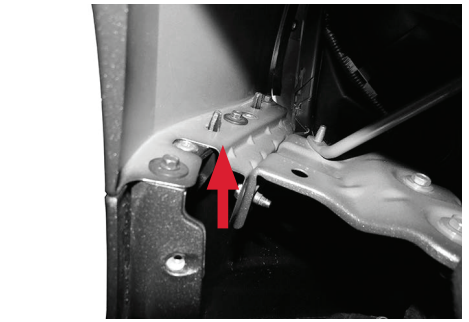
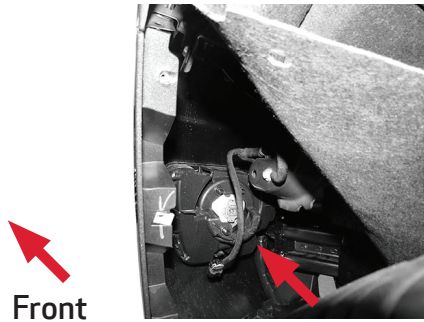

### Step 7

With the front bumper cover removed, locate and remove the top frame bolt on the front bumper.

Insert a 10mm x 80mm hex bolt in through the mounting tab of the support bracket. Slide a tube spacer over the thread of the bolt. Carefully cut the lower section of the air deflector to allow the support bracket to be installed.

Install the passenger-side support bracket. Repeat this process for the driver side.

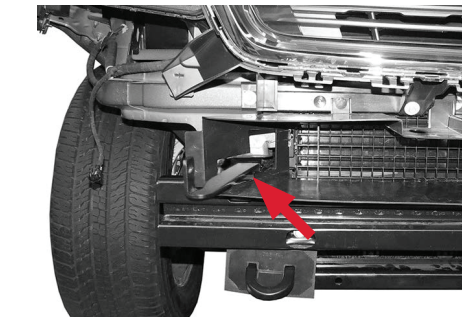
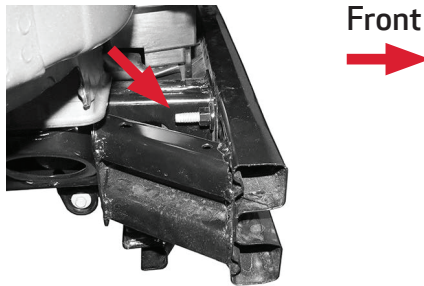

### Step 8 - For vehicles with factory tow hooks

Locate and remove the driver-side tow hook.

Align the tow hook and mounting locations. Insert a double bolt plate in through the center of the vehicle.

Secure the bracket to the frame of the vehicle using two 12mm flat washers and two 12mm nylock nuts. Repeat this process on the passenger side.

With the driver-side and passenger-side lower frame brackets installed, reinstall the front bumper cover, fender liner, plastic fill panel and skid plate.

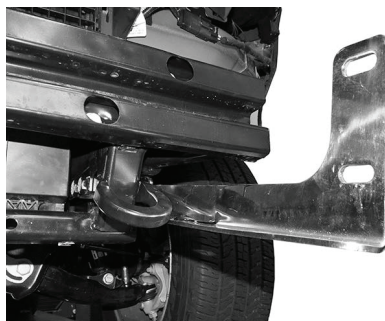



### Step 9A - For vehicles without factory tow hooks

Insert a double bolt plate into the frame mount location.

Place two spacers on the outside of the frame mount location and place the driver side mounting bracket up to the spacers.

Secure the bracket using two 12mm flat washers and two 12mm nylock nuts. Repeat this process for the passenger side.

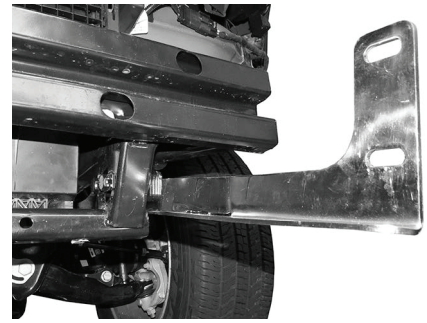
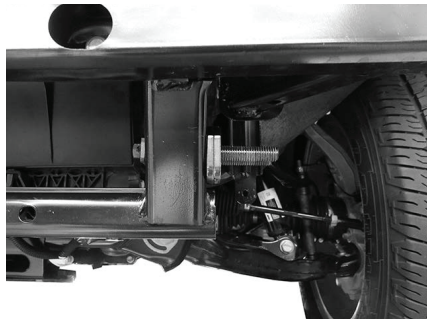

### Step 9B - For vehicles without factory tow hooks

Cut openings in the front bumper to allow the mounting bracket to fit through.

Reinstall the front bumper cover, fender liner, plastic fill panel and skid plate.

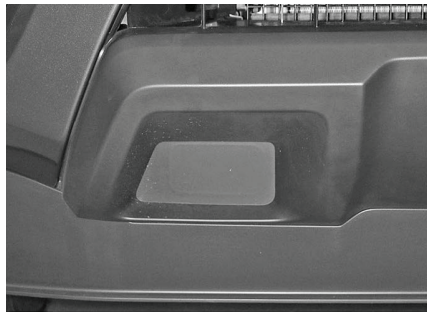

### Step 10

Secure the top support brackets to the grille guard using an 8mm hex bolt and 8mm flat washer on the outside of the grille guard and an 8mm flat washer and 8mm nylock nut on the inside, for both the driver and passenger sides.

To secure the lower frame brackets to the grille guard, use a 10mm hex bolt and 10mm flat washer on the outside of the grille guard and a 10mm flat washer and 10mm nylock nut on the inside for both driver and passenger-side mounting points.

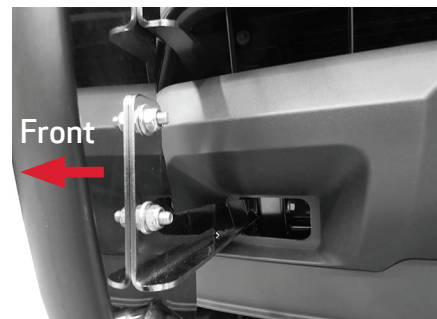
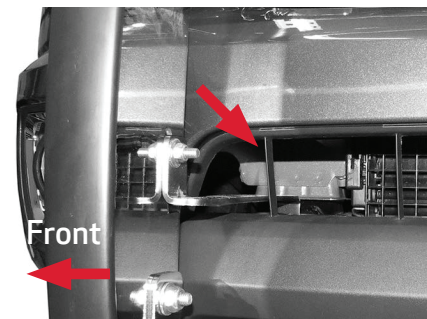

### Step 11

Once the grille guard is aligned, tighten all hardware.

Congratulations on the installation of your new ARIES Pro Series™ grille guard.

With the grille guard installed, periodic inspections should be performed to ensure all mounting hardware remains tight.

To protect your investment, see the 'Notes and Maintenance' section on the first page of this instruction manual.

