

# INSTALLATION INSTRUCTIONS

2007-13 SILVERADO 1500

PART # P4068

## PARTS LIST:

1	Grille Guard	10	12mm x 24mm OD x 2.5mm STD Flat Washers
1	Driver/Left Top Bracket	12	12mm x 32mm OD x 3mm Large Flat Washers
1	Passenger/Right Top Bracket	12	12mm Nylon Lock Nuts
2	Frame Mounting Brackets	2	10-1.50mm x 25mm Button Head Bolts
2	Lower Frame Support Brackets	4	10mm x 20mm x 2mm Flat Washers
2	12-1.75mm x 40mm Bolt Plates (#11)	2	10mm Nylon Lock Nuts
2	12mm Plastic Retainers	2	600mm x 50mm x 1.0mm Adhesive Backed Foam Tape
2	12-1.75mm x 140mm Hex Bolts	1	6mm Allen Wrench
8	12-1.75mm x 30mm Hex Bolts	1	Support Flange
2	8mm Nut Clips	2	8mm Flat Washers
2	8mm Hex Bolts	2	8mm Lock Washers

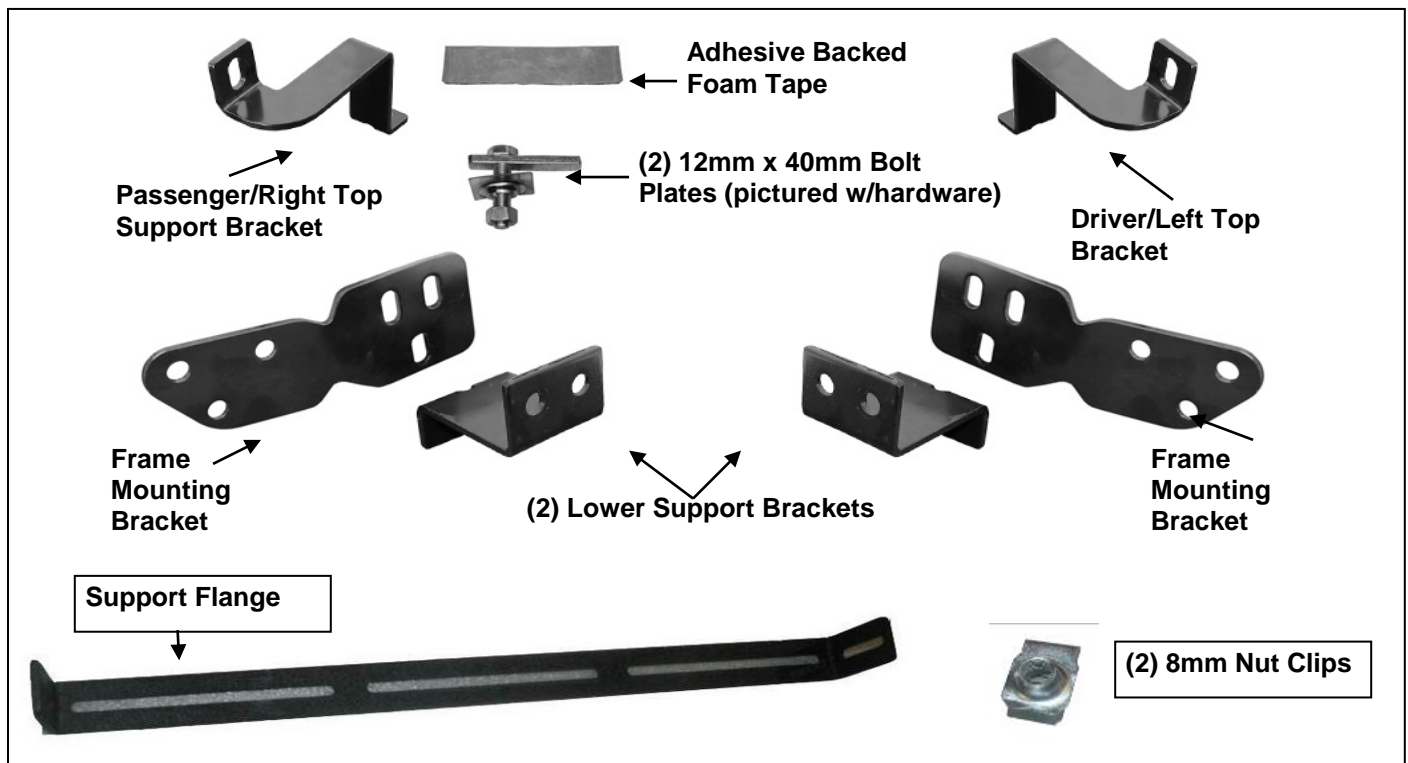

## PROCEDURE:

1. REMOVE CONTENTS FROM BOX AND VERIFY ALL PARTS ARE PRESENT. READ INSTRUCTIONS CAREFULLY. DO NOT ATTEMPT INSTALLATION ALONE; PERSONAL INJURY OR DAMAGE TO THE VEHICLE MAY RESULT. CUTTING IS REQUIRED.
2. Start by Selecting your LED light (**Sold Separately**) mounting hardware & brackets, you will need to first attached the hardware to the support flange, (Example of LED light attached **Fig 1**) **NOTE: if you have your own LED light, LED Manufactures will have similar but different mounting styles or brackets, once you determine you mounting options attach it to the support flange as seen in (Fig1)**

3. With the LED light attached to the support flange select the (2) 8mm nut clips place each nut clip into the slotted holes on either side of the support flange, as seen in **(Fig 2)** with the support flange prepare you will need to lay the grill guard face down to install the support flange **NOTE:** (it is recommended to lay out some of the cardboard your grill guard came in or a blanket to protect the grill guard finish). place the grill guard face down with this done place the support flange with the LED attached into the Center flange attach each side of the support flange to the inner brackets inside the center flange of the grill guard with (2) 8mm hex bolts, (2) 8mm flat washers, & (2) 8mm lock washers as seen in **(Fig 3)** Snug but do not tighten at this time.
4. Start installation from under the front of the vehicle. Determine if the vehicle is equipped with tow hooks.
  - a. **Vehicles equipped with tow hooks and/or openings in bumper cover:** Remove the factory tow hooks, if equipped, **(Fig 4)**. **NOTE:** This Grille Guard is not compatible with factory tow hooks.
  - b. **Vehicles without tow hooks and no openings in bumper cover:** Remove the plastic lower bumper cover. Place bumper cover on a clean, stable work surface, **(Fig 5)**.
5. Locate the (2) holes, side by side, in the forward end of each frame channel. Insert (1) Bolt Plate into the open end of the frame channel and out the rearmost hole in the side of the frame, **(Fig 6)**. Thread (1) 12mm Plastic Retainer onto the threaded end of the Bolt Plate to hold the Bolt Plate in position during Bracket installation, **(Fig 7)**.
  - a. **On the passenger side**, the (2) holes are on the outer wall of the frame rail, **(Figs 6, 7 & 10A)**.
  - b. **On the driver side**, the (2) holes will be on the inner wall of the frame, **(Fig 11B)**.
6. Select (1) Mounting Bracket and (1) Support Bracket. **NOTE, on vehicles with openings in bumper cover**, it may be necessary to enlarge the (2) openings in the bumper cover slightly to clear the Mounting Brackets, **(Fig 9)**. Trim cover as required to install Brackets.
  - a. **Passenger/Right side Mounting Bracket installation:** Secure the Mounting Bracket to the Bolt Plate with (1) 12mm x 24mm STD Flat Washer and (1) 12mm Nylon Lock Nut. Select (1) Lower Support Bracket. Line up the forward hole in the Support Bracket with the hole in the inner wall of the frame channel. Insert (1) 12mm x 140mm Long Hex Bolt and (1) 12mm x 24mm STD Flat Washer through the Support Bracket, both sides of the frame channel and out the remaining hole in the Mounting Bracket, **(Figs 8, 10A & 10B)**. Secure with the included (1) 12mm x 24mm STD Flat Washer and (1) 12mm Nylon Lock Nut.  
Line up the hole in the bottom of the Support Bracket with the lower hole in the Mounting Bracket. Bolt the (2) Brackets together with the included (1) 12mm x 30mm Hex Bolt, (2) 12mm x 24mm STD Flat Washers and (1) 12mm Nylon Lock Nut, **(Figs 10A & 10B)**. Do not fully tighten hardware.
  - b. **Driver/Left side Mounting Bracket installation:** Select (1) Lower Support Bracket. Line up the rear hole in the Support Bracket with the previously installed Bolt Plate. Secure the Support Bracket to the Bolt Plate with (1) 12mm x 24mm STD Flat Washer and (1) 12mm Nylon Lock Nut, **(Figs 11A & 11B)**. Do not tighten at this time.  
Select (1) Mounting Bracket. Insert (1) 12mm x 140mm Long Hex Bolt and (1) 12mm x 24mm STD Flat Washer through the forward hole in the Support Bracket, both sides of the frame channel and out the forward hole in the Mounting Bracket, **(Figs 11A & 11B)**. Secure the Mounting Bracket with the included (1) 12mm x 24mm STD Flat Washer and (1) 12mm Nylon Lock Nut.  
Bolt the bottom of the Support Bracket to the Mounting Bracket as previously described in **Step 6a**, **(Figs 11A & 11B)**. Do not fully tighten hardware.
7. Next, open the hood and remove the plastic cover between the top of the grille and the radiator. **NOTE:** Use a small flat head screw driver to pop up the center of the plastic clips. Remove the two outer bolts from the grille shell. Use a pair of "needle nose" pliers to carefully squeeze the back of the clips to release as you gently pull the grill forward, **(Fig 12)**. **IMPORTANT:** Do not damage the clips holding the grille in place. Once all of the clips have been released, carefully remove the grille by gently pulling it forward from the vehicle

8. Remove the long factory top bumper bracket bolt behind the bumper on the top of the frame. Select the driver side Top Bracket. Apply a layer of Adhesive Backed Foam Tape to the inside of the Bracket to protect the finish on the bumper, **(Fig 13)**. **IMPORTANT:** To prevent the Top Brackets from damaging the finish on the vehicle during installation, cover the top of the bumper with removable tape, (masking tape). Secure the Top Bracket to the bumper bracket with the factory hex bolt, **(Figure 14)**. Leave the hardware loose at this time. Repeat this Step to install the passenger side Top Bracket.
9. With assistance, hold the Grille Guard up in position on the outside of the Mounting Brackets. Bolt the Grille Guard to the Brackets with (6) 12mm x 30mm Hex Bolts, (12) 12mm x 32mm Large Flat Washers and (6) 12mm Nylon Lock Nuts, **(Figs 10A & 10B)**. Snug but do not tighten hardware at this time.
10. Line up the driver side Top Bracket with the hole in the upright on the Grille Guard. Bolt the Top Bracket to the upright with (1) 10mm Button Head Bolt, (2) 10mm Flat Washers and (1) 10mm Nylon Lock Nut, **(Fig 15)**. Do not tighten hardware at this time. Repeat for passenger side Top Bracket installation.
11. Level and adjust the Grille Guard. Make sure that the Top Brackets do not come in contact with the top of the bumper cover.
  - a. **Vehicles equipped with tow hooks and/or opening in bumper cover:** Proceed to tighten all hardware.
  - b. **Vehicles without tow hooks and no openings in bumper cover:** Tighten the lower Mounting Bracket hardware only. Temporarily remove the Grille Guard. Hold the lower bumper cover up in position and mark the location of the Mounting Brackets onto the back of the cover. Cut (2) vertical slots through the bumper cover to clear the Brackets. Cut as little as possible from the bumper cover. Reinstall the bumper cover over the Brackets. Reinstall the Grille Guard as described in **Steps 10 – 11**. Level and adjust the Grille Guard and tighten all hardware at this time.
12. Once all mounting hardware is tight, line up the clips on the grille with the mounting tabs, **(Step 7)**, and gently push the grille back into place. Reinstall the top plastic cover.
13. **For the Led lights wiring please refer to the manufactures installation.**
14. Do periodic inspections to the installation to make sure that all hardware is secure and tight.

**To protect your investment**, wax this product after installing. Regular waxing is recommended to add a protective layer over the finish. Do not use any type of polish or wax that may contain abrasives that could damage the finish.

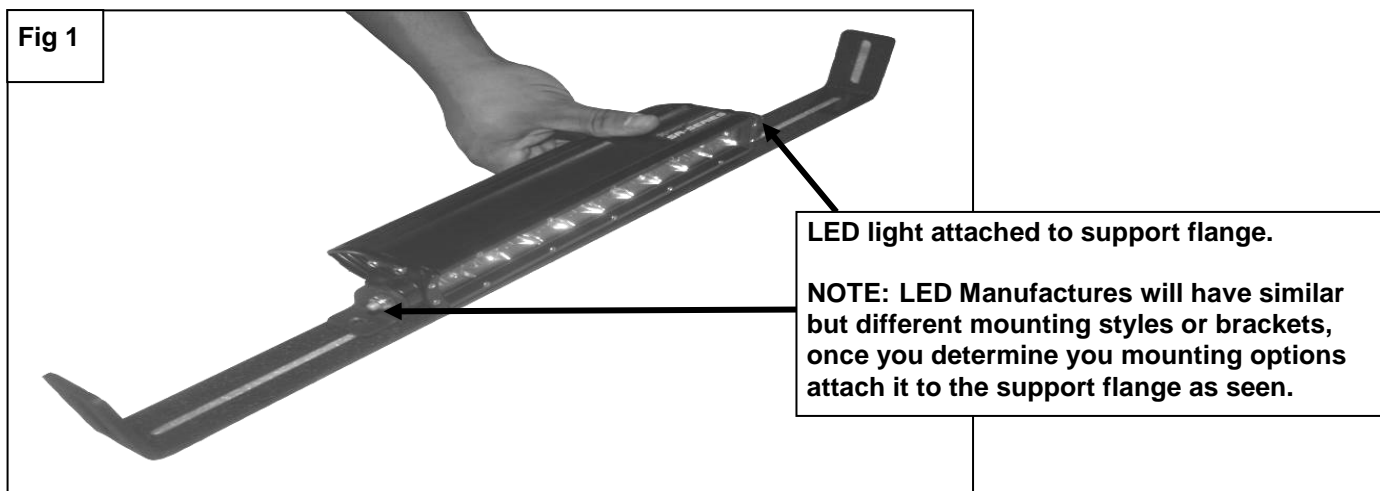

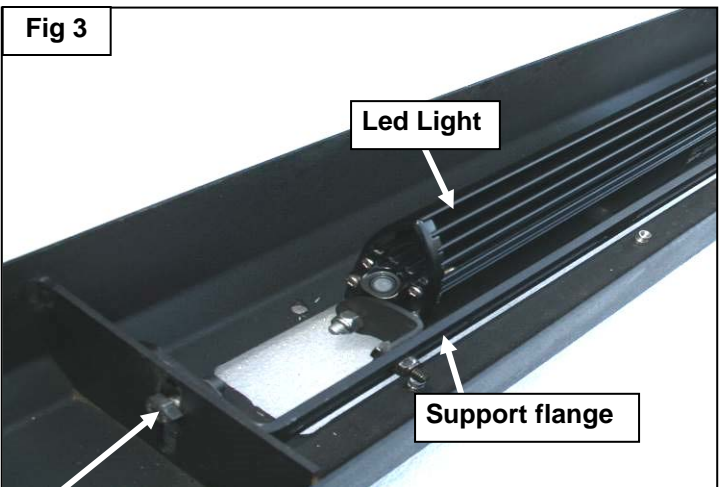
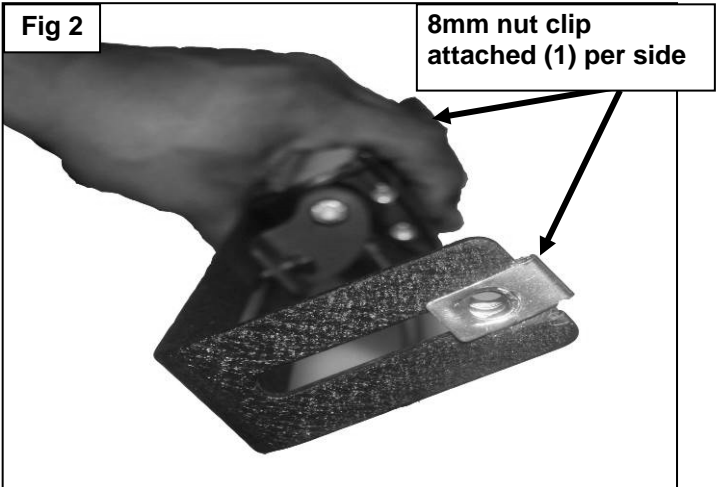

Secure support flange into center flange with  
 (1) 8mm Hex head bolt  
 (1) 8mm Flat Washers  
 (1) 8mm Lock washer  
 Per side.



**(Fig 4) Opening for tow hook pictured**



**(Fig 5) No opening in bumper cover**

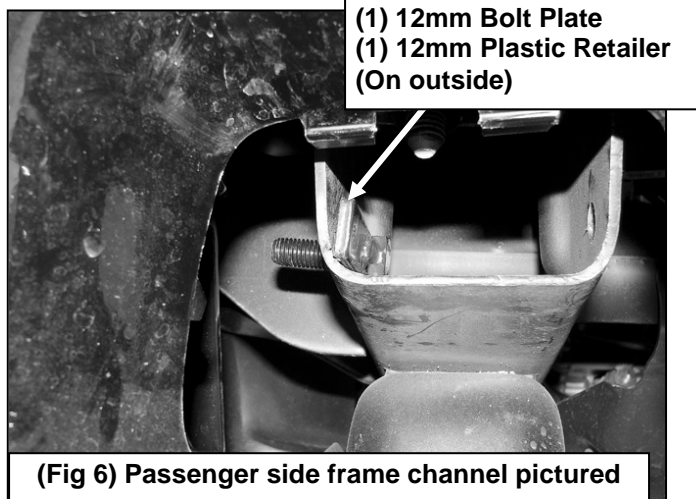

**(Fig 6) Passenger side frame channel pictured**

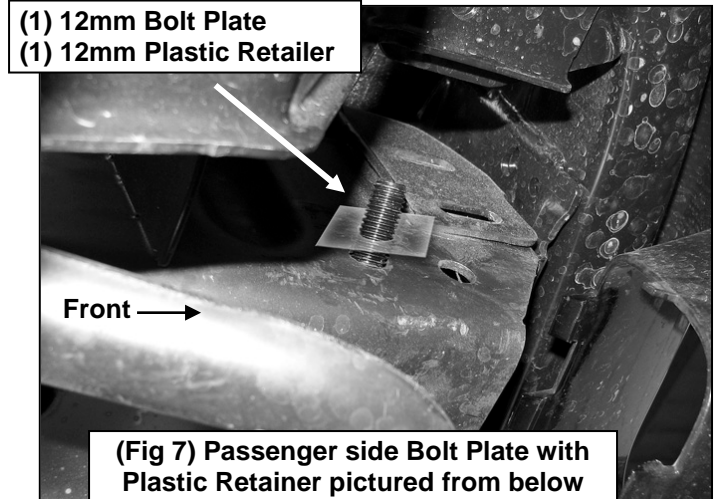

**(Fig 7) Passenger side Bolt Plate with Plastic Retainer pictured from below**

**Passenger Side Mounting Bracket Installation Pictured**

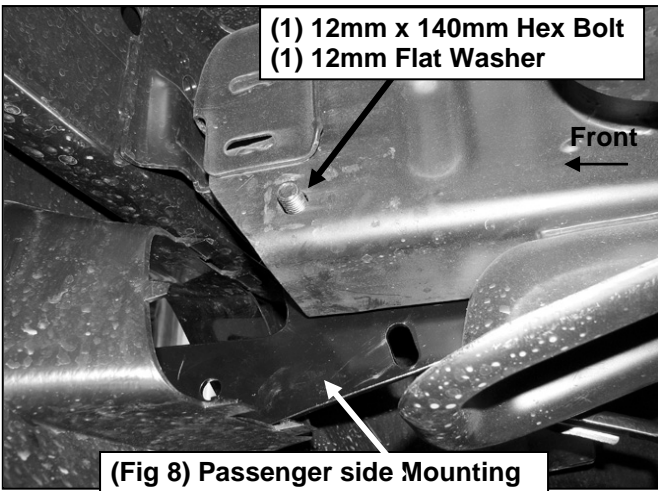

**(Fig 8) Passenger side Mounting Bracket installation pictured**

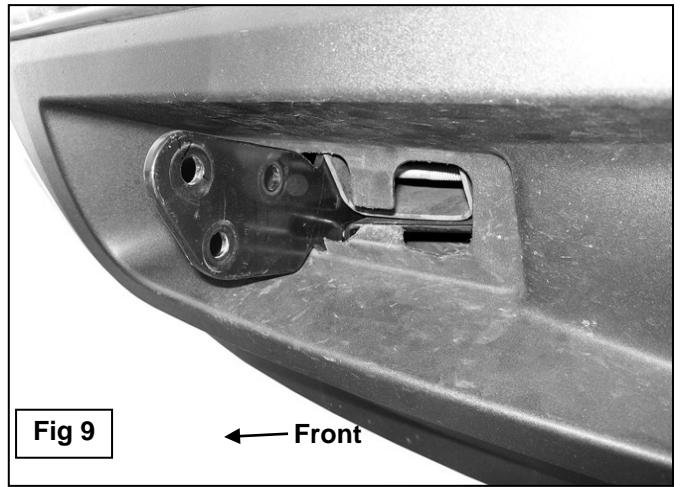

**Fig 9**

- (1) 12mm Bolt Plate
- (1) 12mm Plastic Retailer
- (1) 12mm Flat Washer
- (1) 12mm Nylon Lock Nut

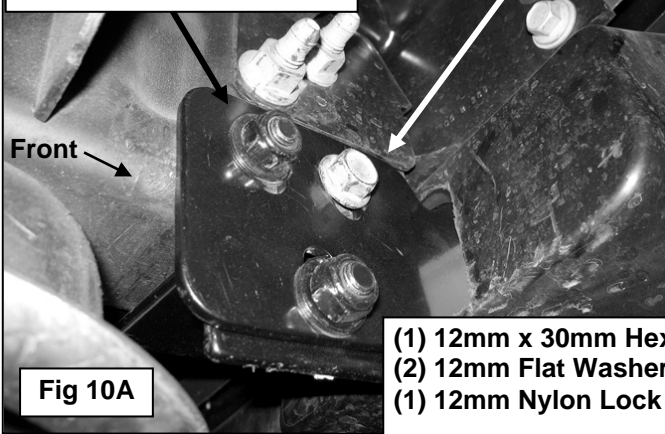

**Fig 10A**

- (1) 12mm x 140mm Hex Bolt
- (1) 12mm Flat Washer

- (1) 12mm x 140mm Hex Bolt
- (2) 12mm Flat Washer
- (1) 12mm Nylon Lock Nut

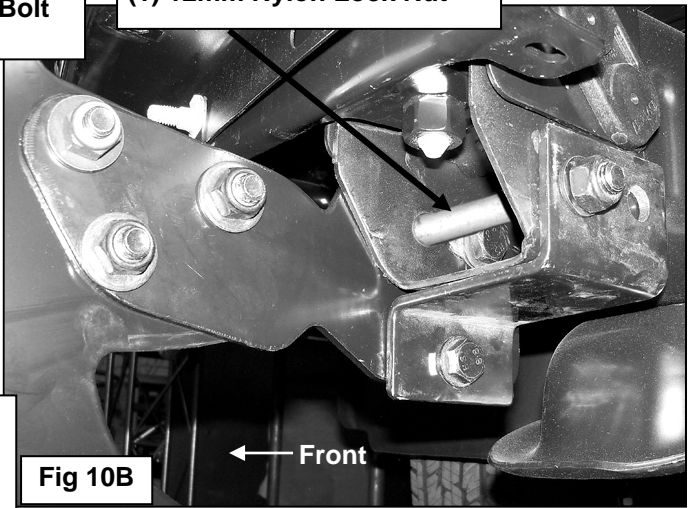

**Fig 10B**

**Driver Side Mounting Bracket Installation Pictured**

- (1) 12mm x 140mm Hex Bolt
- (2) 12mm Flat Washer
- (1) 12mm Nylon Lock Nut

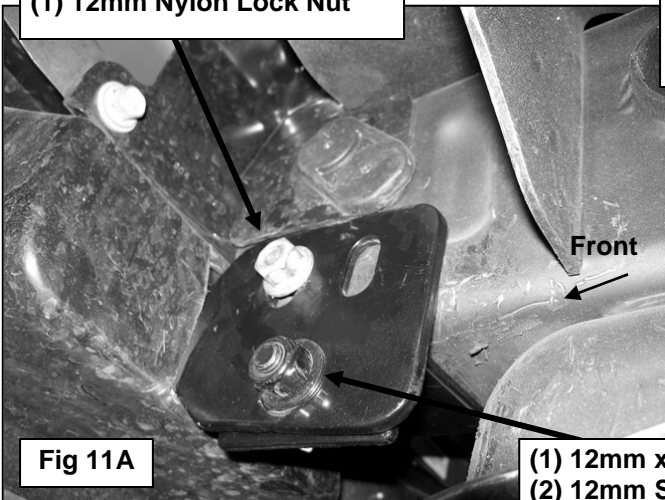

**Fig 11A**

- (1) 12mm Bolt Plate
- (1) 12mm Plastic Retailer
- (1) 12mm Flat Washer
- (1) 12mm Nylon Lock Nut

- (1) 12mm x 30mm Hex Bolt
- (2) 12mm Large Flat Washers
- (1) 12mm Nylon Lock Nut

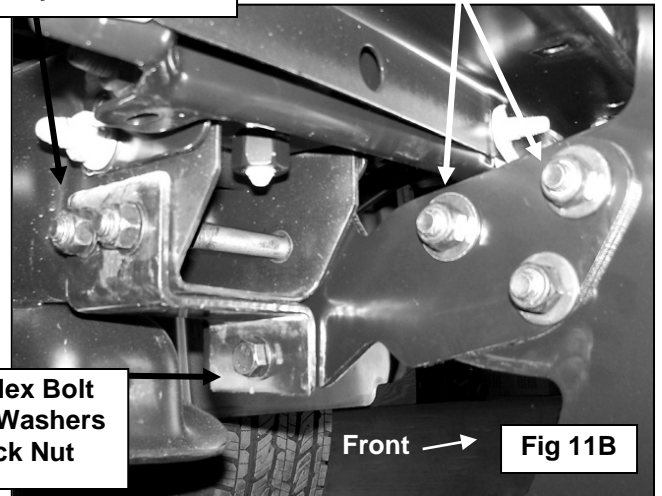

**Fig 11B**

- (1) 12mm x 30mm Hex Bolt
- (2) 12mm STD Flat Washers
- (1) 12mm Nylon Lock Nut

## Driver Side Mounting Bracket Installation Pictured

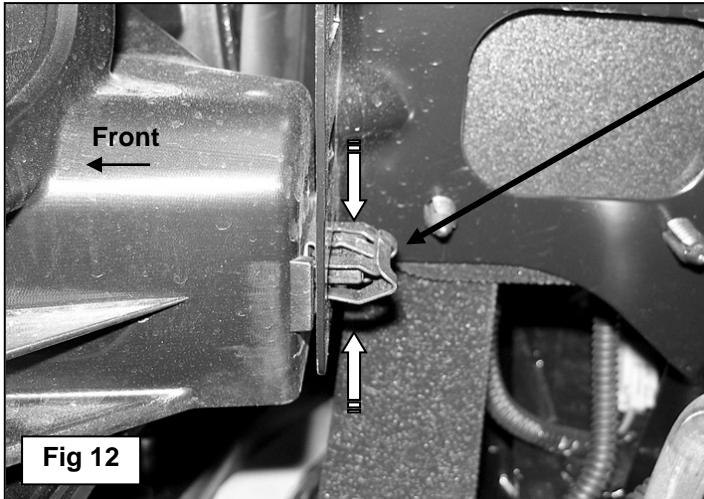

Use a pair of needle nose pliers to carefully pinch the top and bottom tab on the clip to release and remove the grille

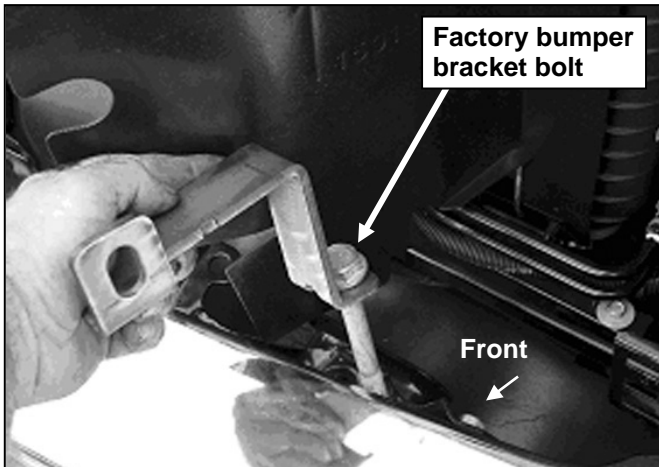
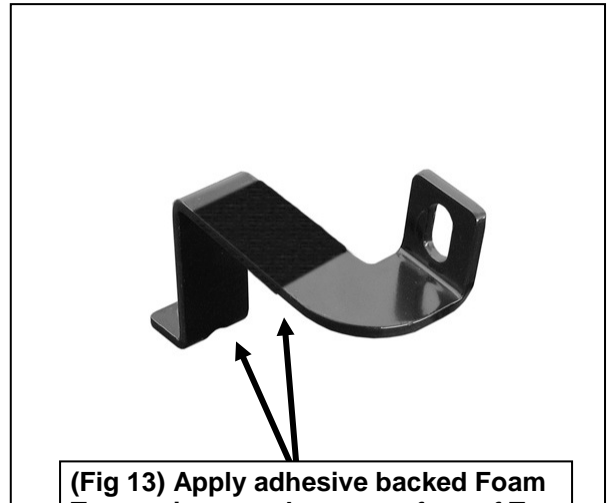

(Fig 14) Driver side Top Bracket installation pictured without foam for instruction purposes only

- (1) 10mm Button Head Bolt
- (2) 10mm Flat Washers
- (1) 10mm Nylon Lock Nut

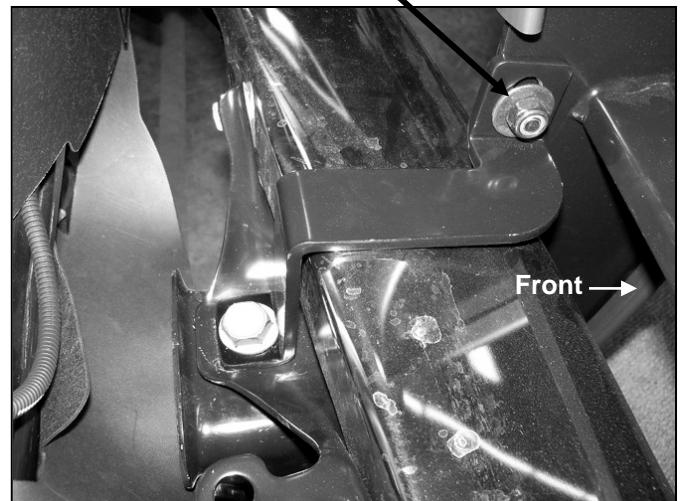

(Fig 15) Driver side Top Bracket installation pictured. Apply foam tape to Bracket. Apply a layer of masking tape to the top of the bumper for protection during installation