

INSTALLATION INSTRUCTIONS

2005-2013 TACOMA GRIL GUARD

PART# 2054 / 2054-2

(Skid Plate Must be removed- If Equipped)

PARTS LIST:

1	Grille Guard	8	12mm lock washers
1	Driver/Left Mounting Bracket	2	10mm x 30mm Button Head Bolts
1	Passenger/Right Mounting Bracket	4	10mm x 27mm OD x 3mm Large Flat Washers
1	Driver/Left Top Bracket	4	10mm Hex Nuts
1	Passenger/Right Top Bracket	4	10mm lock washers
2	10mm x 30mm "T" Bolts	2	8mm Clip Nuts
2	12mm x 120mm Hex Bolts	2	8mm Flat washers
6	12mm x 35mm Hex Bolts	2	8mm Button head bolts
16	12mm x 32mm OD x 3mm Flat Washers	1	Support flange
8	12mm Hex Nut		

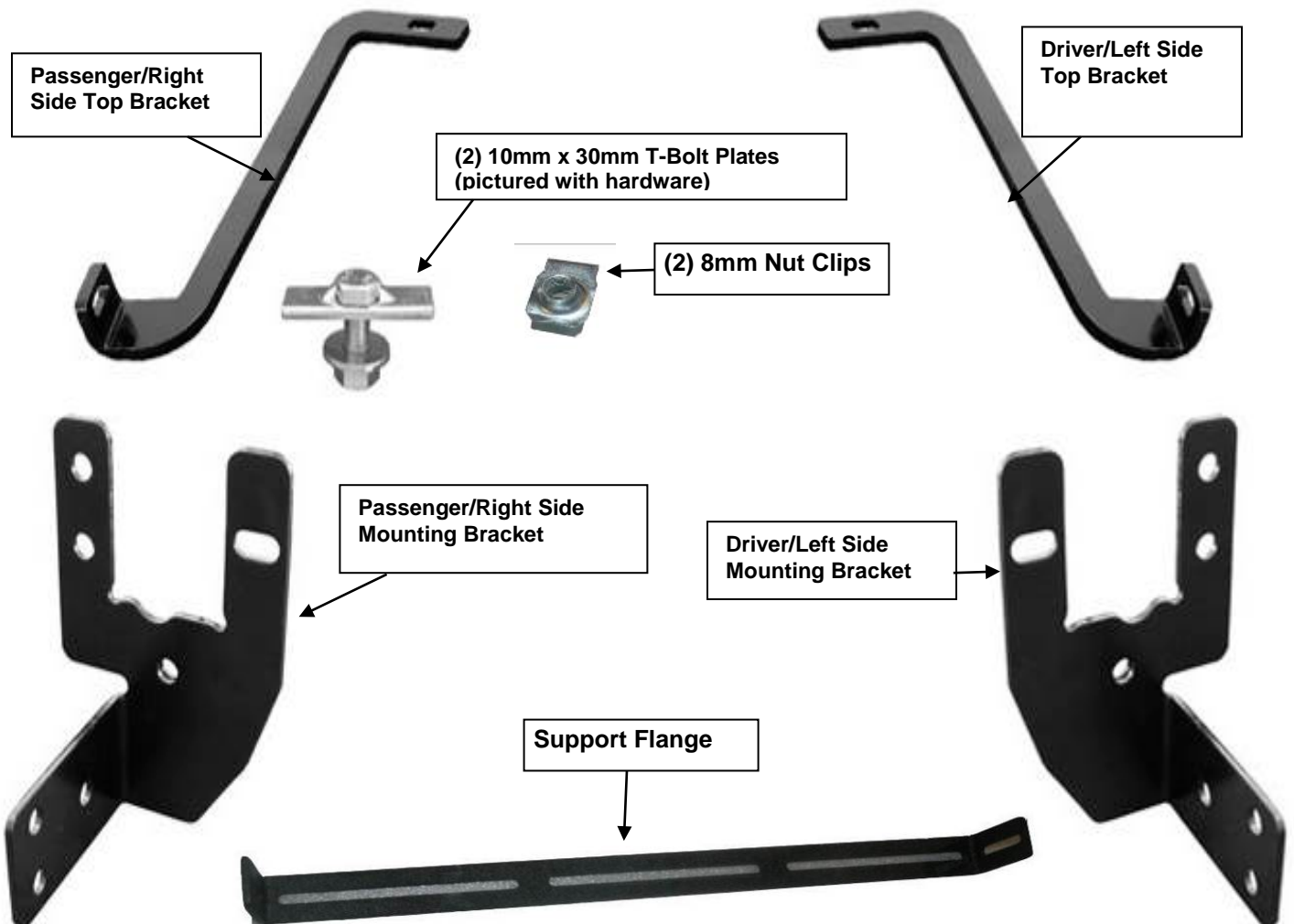

PROCEDURE:

- 1. REMOVE CONTENTS FROM BOX. VERIFY ALL PARTS ARE PRESENT. READ INSTRUCTIONS CAREFULLY BEFORE STARTING INSTALLATION. DO NOT ATTEMPT INSTALLATION ALONE; PERSONAL INJURY OR DAMAGE TO THE TRUCK MAY RESULT.**
2. Start by Selecting your LED light (**Sold Separately**) mounting hardware & brackets, you will need to first attached the hardware to the support flange, (Example of LED light attached Fig 1) **NOTE: if you have your own LED light, LED Manufactures will have similar but different mounting styles or brackets, once you determine you mounting options attach it to the support flange as seen in (Fig1)**
3. With the LED light attached to the support flange select the (2) 8mm nut clips place each nut clip into the slotted holes on either side of the support flange, as seen in **(Fig 2)** with the support flange prepare you will need to lay the grill guard face down to install the support flange **NOTE:** (it is recommended to lay out some of the cardboard your grill guard came in or a blanket to protect the grill guard finish). place the grill guard face down with this done place the support flange with the LED attached into the Center flange attach each side of the support flange to the upright plates of the grill guard with (2) 8mm flat washers, & (2) 8mm button head bolts as seen in **(Fig 3)** Snug but do not tighten at this time.
4. Next starting on the driver/left side, remove the (3) factory nuts securing the bumper support to the end of the frame channel, **(Fig 4 - 6)**.Note: If vehicle is equipped with factory skid shield you will need to remove it, this will not be re-installed.
5. Line-up the (3) upper holes in the driver/left side Frame Mounting Bracket with the threaded studs in the end of the frame channel. Bolt the Bracket to the studs using the existing nuts removed in **Step 4, (Fig 4 - 6)**. Insert (1) 12mm x 120mm Hex Bolt with (1) 12mm Flat Washer through the lower mounting hole in the bracket and into the end of the frame channel. Use the included (1) 12mm Flat Washer and (1) 12mm Nylon Lock Nut to secure the Bracket to the lower mounting hole, **(Fig 4 & 6)**. Tighten hardware at this time.
6. Repeat **Steps 4 - 5** for passenger/right side Frame Mounting Bracket installation.
7. Open the hood on the vehicle. Locate the factory hole on each side of the bottom of the radiator support cross member behind the grille insert, **(passenger/right side pictured-Fig 7)**. Select (1) 10mm Bolt Plate. Insert the Bolt Plate through the back of the cross member and down through the hole in the bottom of the cross member, **(Fig 7 - 10)**.
8. Slide the driver/left side Top Bracket through the plastic grille opening and attach it to the previously inserted Bolt Plate using the included (1) 10mm Flat Washer and (1) 10mm Nylon Lock Nut, **(Fig 7)**. Do not tighten hardware. Repeat this Step for remaining Top Bracket installation.
9. With assistance, position the Grille Guard onto the inside of the Mounting Brackets. Use the included (6) 12mm x 35mm Hex Bolts, (12) 12mm Flat Washers and (6) 12mm Nylon Lock Nuts to attach the Grille Guard to the Mounting Brackets, **(Fig 5 & 6)**.
10. Line up the mounting hole in the passenger side Top Bracket with the corresponding hole in the upright on the Grille Guard. Bolt the Top Bracket to the Grille Guard with the included 10mm x 30mm Button Head Bolt, (1) 10mm Flat Washer and 10mm Nylon Lock Nut, **(Fig 10)**. Do not tighten hardware at this time. Repeat this Step to bolt the driver side Top Bracket to the Grille Guard.
11. Align the Grille Guard properly and tighten all hardware.
12. Do periodic inspections to the installation to make sure that all hardware is secure and tight.

To protect your investment, wax this product after installing. Regular waxing is recommended to add a protective layer over the finish. Do not use any type of polish or wax that may contain abrasives that could damage the finish.

For black finishes: Mild soap may be used to clean the Grille Guard.

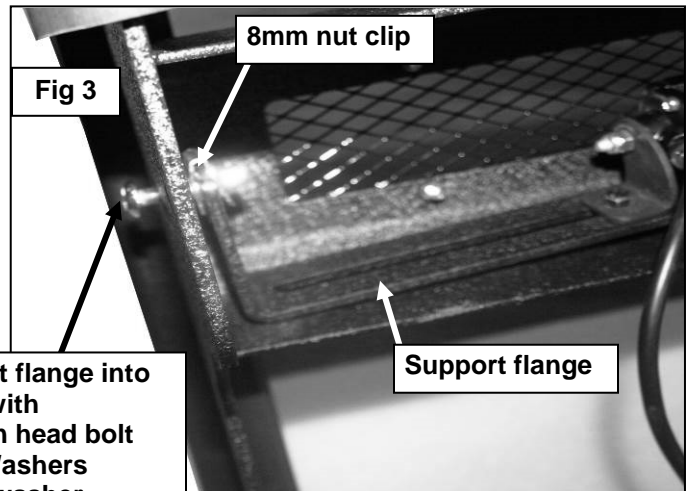
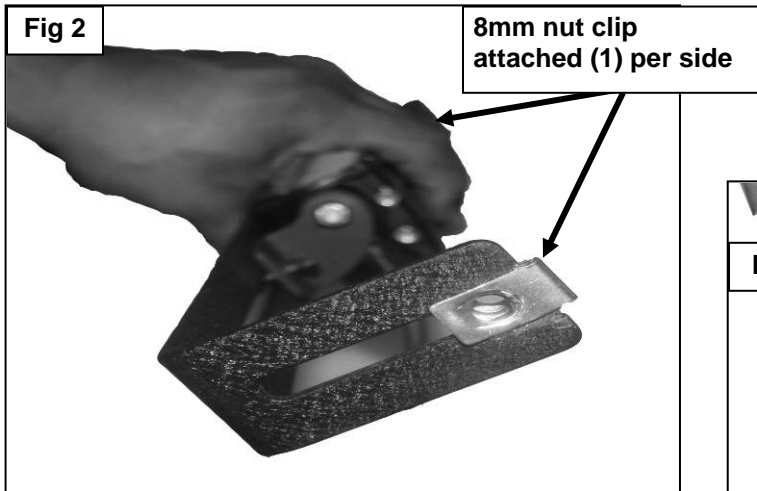
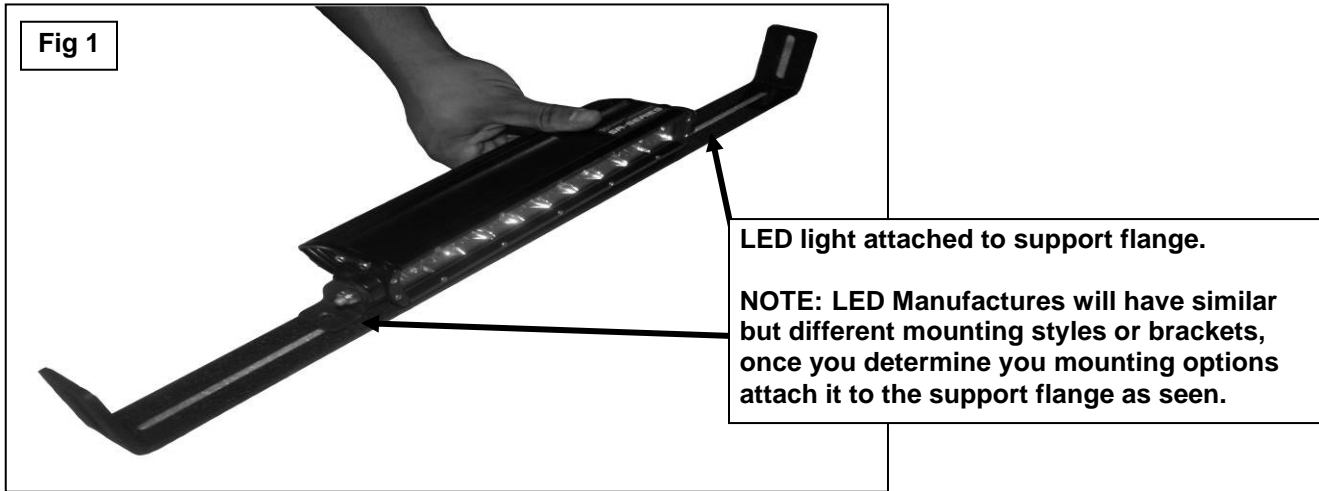

Secure support flange into center flange with
(1) 8mm Button head bolt
(1) 8mm Flat Washers
(1) 8mm Lock washer
Per side.

Fig 4

Driver Side Installation Pictured

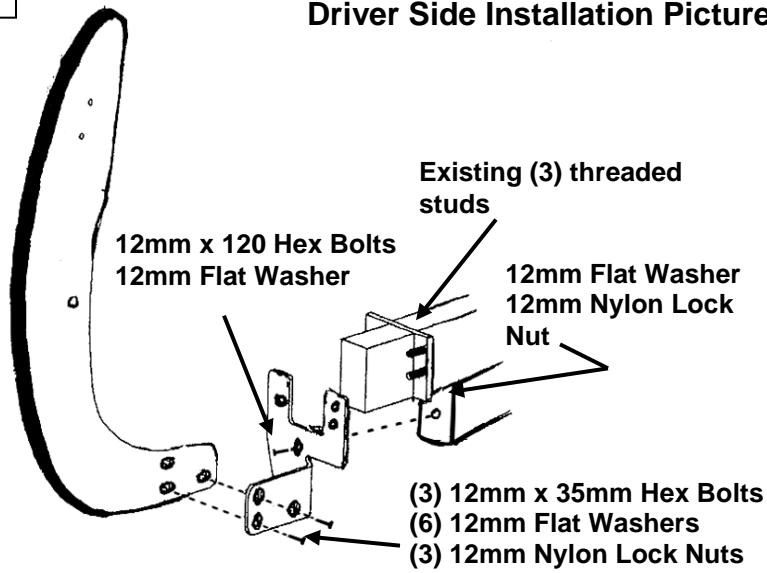

Factory hex nuts bolting driver side Frame Bracket to end of frame channel

(3) 12mm x 35mm Hex Bolts
(6) 12mm Flat Washers
(3) 12mm Nylon Lock Nuts

(1)12mm x 120 mm Hex Bolts
(2)12mm Flat Washers
(1)12mm Nylon Lock Nut

Fig 5

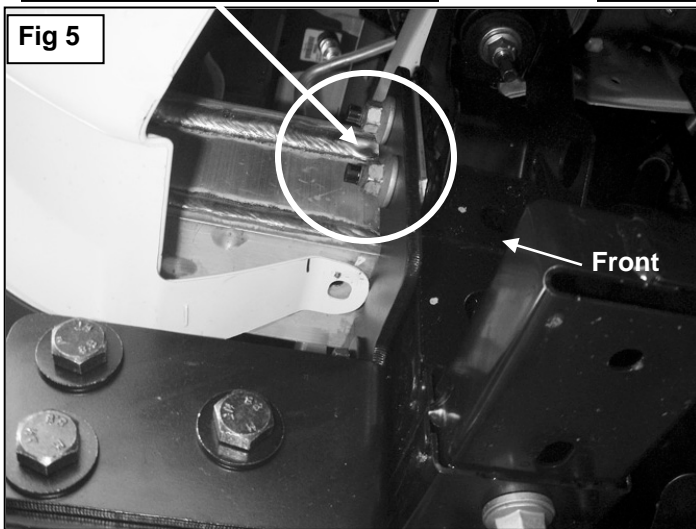
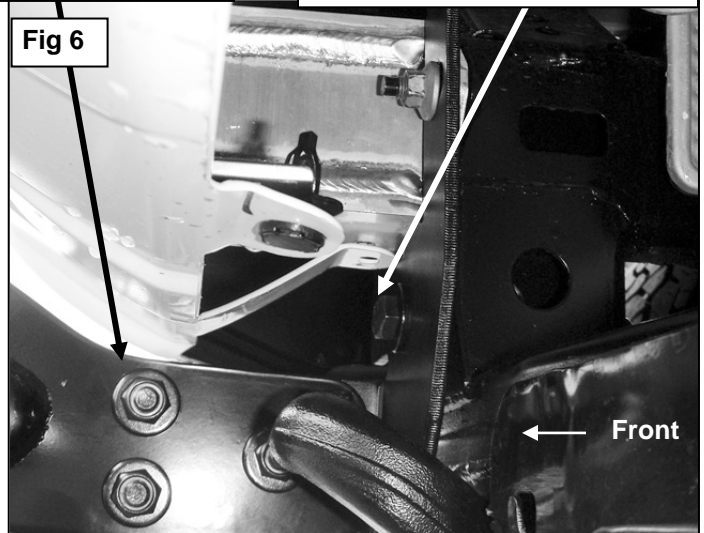
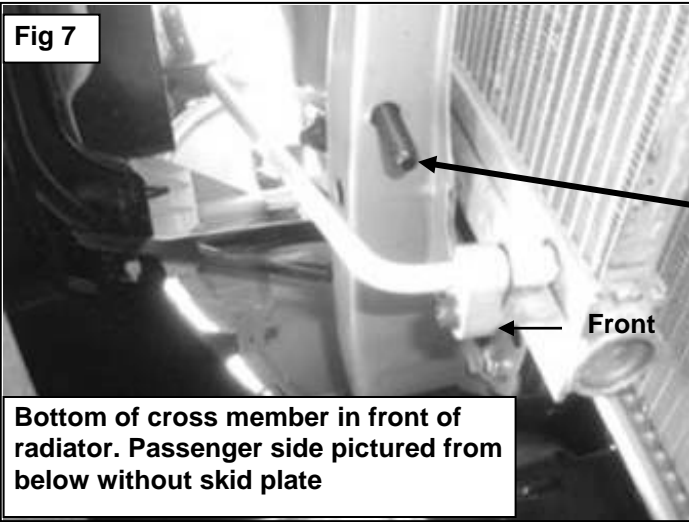

Fig 6



NOTE: It is not necessary but it may be easier to bolt the Top Brackets to the horizontal cross member in front of the radiator after the factory skid plate has been removed



Insert T-Bolt Plate from behind and through hole in bottom of cross member

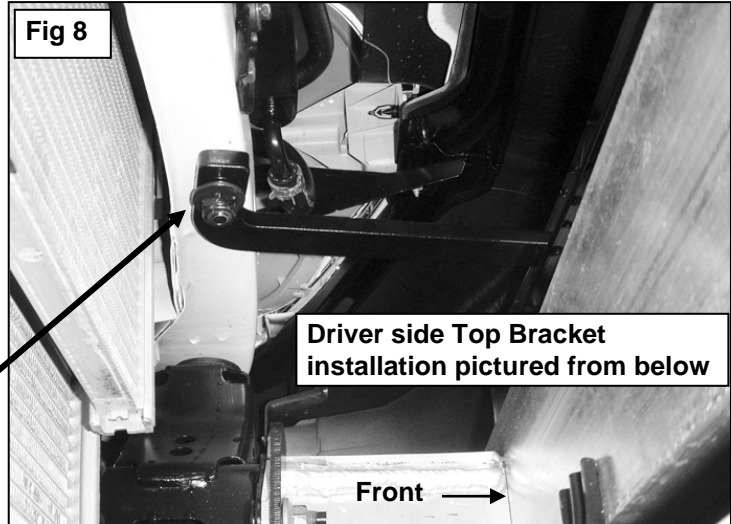

10mm T-Bolt Plate
10mm Flat Washer
10mm x 27mm Large Flat Washer
10mm Nylon Lock Nut

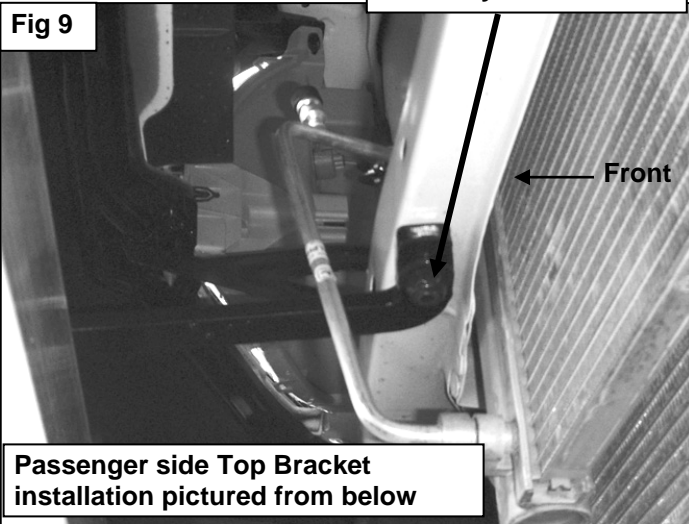

Bolt the Top Bracket to the Grille Guard
10mm x 30mm Button Head Bolt
10mm Flat Washer
10mm Nylon Lock Nut

