



INSTALLATION INSTRUCTIONS

GRILLE GUARD

2014-15 SILVERADO 1500

PART # 4083/ 4083-2

PARTS LIST:

Qty	Description	Qty	Description
1	Grille Guard Assembly	6	12-1.75mm Hex Nuts
2	Frame Brackets	4	10-1.50mm x 30mm Hex Bolts
1	Driver/Left Mounting Bracket	8	10mm x 27mm OD x 3mm Flat Washers
1	Passenger/Right Mounting Bracket	4	10mm Lock Washers
1	Driver/Left Top Bracket	4	10-1.50mm Hex Nuts
1	Passenger/Right Top Bracket	2	8-1.25mm x 25mm Button Head Allen Bolts
1	Driver/Left Top Inner Support Bracket	6	8-1.25mm x 30mm Hex Bolts
1	Passenger/Right Top Inner Support Bracket	10	8mm x 16mm OD x 1.6mm Flat Washers
2	Top Support Rear Backing Plates	6	8mm Lock Washers
2	12-1.75mm x 30mm Double Bolt Plates	2	8-1.25mm Nylon Lock Nuts
2	12-1.75mm x 35mm Single Bolt Plates	8	6-1.0mm x 25mm Hex Bolts
6	12mm x 24mm OD x 2.5mm Flat Washers	8	6mm x 18mm OD x 1.6mm Flat Washers
6	12mm Lock Washers	8	6mm Lock Washers

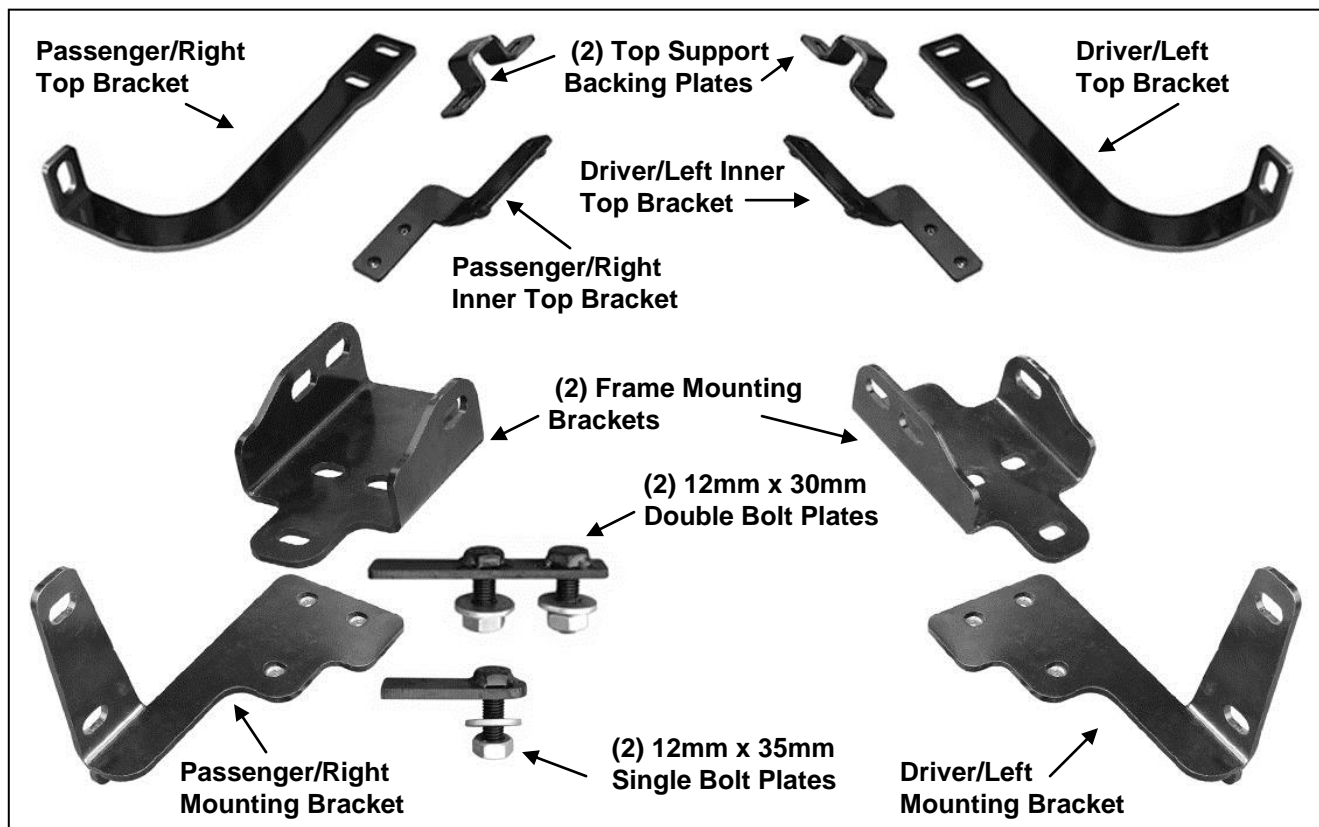

PROCEDURE:

REMOVE CONTENTS FROM BOX AND VERIFY ALL PARTS ARE PRESENT. READ INSTRUCTIONS CAREFULLY. DO NOT ATTEMPT INSTALLATION ALONE; PERSONAL INJURY OR DAMAGE TO THE VEHICLE MAY RESULT. CUTTING MAY BE REQUIRED. ASSISTANCE IS HIGHLY RECOMMENDED. INSTALLATION MAY INTERFERE WITH FRONT MOUNTED SENSORS.

1. Start installation from under the front of the vehicle. Determine if the vehicle is equipped with tow hooks. **IMPORTANT:** Tow hooks cannot be reinstalled with the Grille Guard.

Tow Hook equipped vehicles:

- a. Remove the factory tow hook from the end of each frame channel, **(Figure 1)**. **NOTE:** The driver side tow hook removal is difficult and assistance is highly recommended.
 - i. **Tow hook removal-option 1:** Remove the hex bolts securing the driver side of the bumper to the bracket. Use a short pry bar or large screwdriver to move the tab on the bumper bracket up and away to clear the hex bolt and slide it out past the bumper bracket, **(Figures 2A, 2B & 5)**.
 - ii. **Option 2:** Remove plastic radiator grille. Loosen and/or completely remove the front bumper to remove the long hex bolt in the driver side tow hook, **(Figure 2B)**.
- b. Reattach the bumper after both tow hooks have been removed and the openings have been checked for Bracket clearance, **(Figure 5)**. Tighten all factory bumper hardware at this time.
- c. Proceed to **Step 2**.

Vehicles without tow hooks:

- a. Cut out the indented area in both sides of the plastic bumper insert to clear the Brackets as pictured, **(Figures 3 & 4)**. **IMPORTANT:** Make several small cuts for best fit. Do not cut through the top edge of the panel. **NOTE:** The plastic panel is held in place with several small screws. The screws at the top corners are difficult to impossible to reach and remove without damaging the cover with the bumper in place. If you prefer to remove the panel to cut out the openings, it may be necessary or easier to remove the plastic grille then the steel bumper assembly with the plastic panel attached to access all of the small screws and clips.
 - b. Reattach the bumper and/or bumper insert, (if removed), and grille once openings have been cut out and checked for clearance, **(Figure 5)**. Tighten all factory bumper hardware at this time.
2. Select (1) Frame Bracket, **(Figure 6)**. Insert the Bracket through the opening in the plastic bumper, **(Figure 5)**. Line up the (3) holes in the Bracket with the holes in the end of the frame.
 3. Select (1) 12mm Double Bolt Plate, **(Figure 7A)**. Insert the Bolt Plate into the end of the frame, through the (2) holes in the side of the frame and out through the Bracket. Secure the Bracket to the Bolt Plate with (2) 12mm Flat Washers, (2) 12mm Lock Washers and (2) 12mm Hex Nuts, **(Figure 7B)**. Snug but do not fully tighten hardware at this time. Repeat this **Step** to install the 12mm x 35mm Single Bolt Plate, **(Figure 8A)**, into the remaining hole in the other side of the frame channel and Bracket, **(Figures 8B & 8C)**.
 4. Next, select the driver side Mounting Bracket. Bolt the Mounting Bracket to the bottom of the Frame Bracket with (3) 8mm x 30mm Hex Bolts, (3) 8mm Lock Washers and (3) 8mm Flat Washers, **(Figures 9 & 10)**. Do not tighten hardware at this time.
 5. Repeat **Steps 2—4** to install the passenger side Frame and Mounting Brackets.
 6. With assistance, hold the Grille Guard up in position on the outside of the Mounting Brackets. Bolt the Grille Guard to the Brackets with (4) 10mm x 30mm Hex Bolts, (8) 10mm Flat Washers, (4) 10mm Lock Washers and (4) 10mm Hex Nuts, **(Figure 10)**. Do not tighten hardware at this time.
 7. Check the Grille guard alignment with the vehicle. Adjust as required then tighten first the Frame Bracket hardware then the (6) 8mm Hex Bolts securing the Mounting Brackets to the bottom of the Frame Brackets. Do not fully tighten the Grille Guard to Bracket hardware at this time.
 8. Next, open the hood and remove the plastic cover between the top of the grille and the radiator, **(Figure 11)**. **NOTE:** Use a small flat blade screw driver to pop up the center of the plastic clips.
 9. Locate and remove the hardware bolting the top of the grille in place. Carefully pull the grille straight out from the vehicle to release the grille from the clips and tilt forward, **(Figure 12)**. **NOTE:** It is not necessary to completely remove the grille, just make sure all hardware has been removed before pulling on grille to release from clips.

10. Locate the square tube support braces running up at an angle from the top of the frame channel to the bottom of the hood release mechanism, **(Figures 13B, 15 & 16)**. Select the driver side Inner Top Bracket and (1) Backing Plate, **(Figure 13A)**. Hold the Inner Bracket up to the bottom of the brace tube with the Backing Plate over the top. Bolt the Brackets together around the square tube with (2) 6mm x 25mm Hex Bolts, (2) 6mm Lock Washers and (2) 6mm Flat Washers, **(Figure 13B)**. Leave loose at this time.
11. Select the driver side Outer Top Bracket, **(Figure 14)**. Insert the Outer Bracket through the grille and up to the Inner Top Bracket assembly, **(Figures 15 & 16)**. Slide the Bracket assembly up or down the tube to match up with the Outer Top Bracket. Bolt the Outer Bracket to the top of the Inner Bracket with (2) 6mm x 25mm Hex Bolts, (2) 6mm Lock Washers and (2) 6mm Flat Washers. Leave hardware loose at this time.
12. Line up the outer bent end of the Top Bracket with the hole in the Grille Guard upright. Bolt the bent end of the Outer Top Bracket to the upright with (1) 8mm x 25mm Button Head Allen Bolt, (2) 8mm Flat Washers and (1) 8mm Nylon Lock Nut, **(Figure 17)**.
13. Repeat **Steps 10—12** for passenger side Top Bracket assembly installation, **(Figures 15 & 17)**.
14. Level and adjust the Grille Guard and fully tighten all hardware. **IMPORTANT:** Adjust the position of the Top Brackets so that they cannot come in contact with the plastic grille, **(Figure 17)**.
15. Reinstall the plastic grille if removed. Reinstall the top plastic cover if removed.
16. Do periodic inspections to the installation to make sure that all hardware is secure and tight.

To protect your investment, wax this product after installing. Regular waxing is recommended to add a protective layer over the finish. Do not use any type of polish or wax that may contain abrasives that could damage the finish.

For stainless steel: Aluminum polish may be used to polish small scratches and scuffs on the finish. Mild soap may be used also to clean the Grille Guard.

For gloss black finishes: Mild soap may be used to clean the Grille Guard.

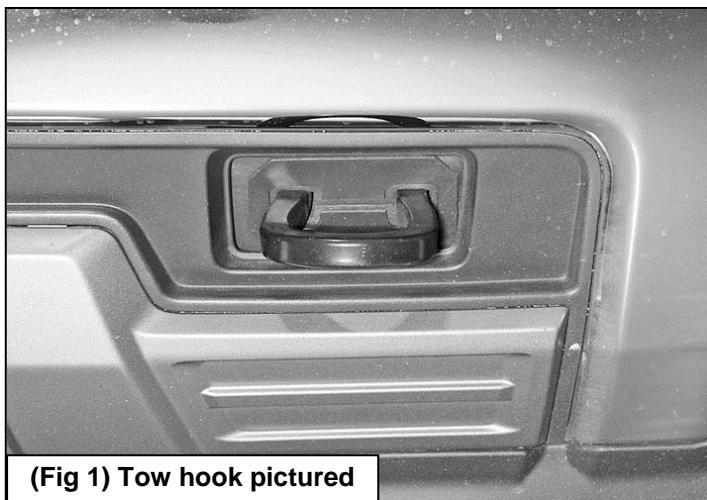

Remove the bolts securing the driver side of the bumper to the bumper bracket. Use a large screwdriver or pry bar to move the mounting tab up enough to get the long bolt through the tow hook out of the end of the frame

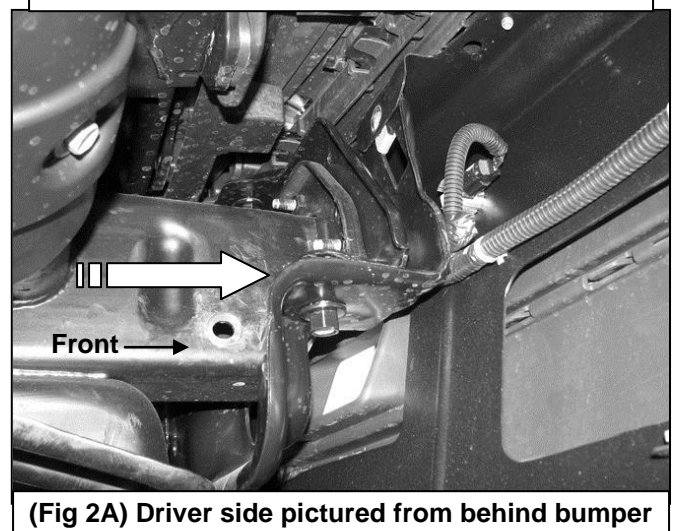

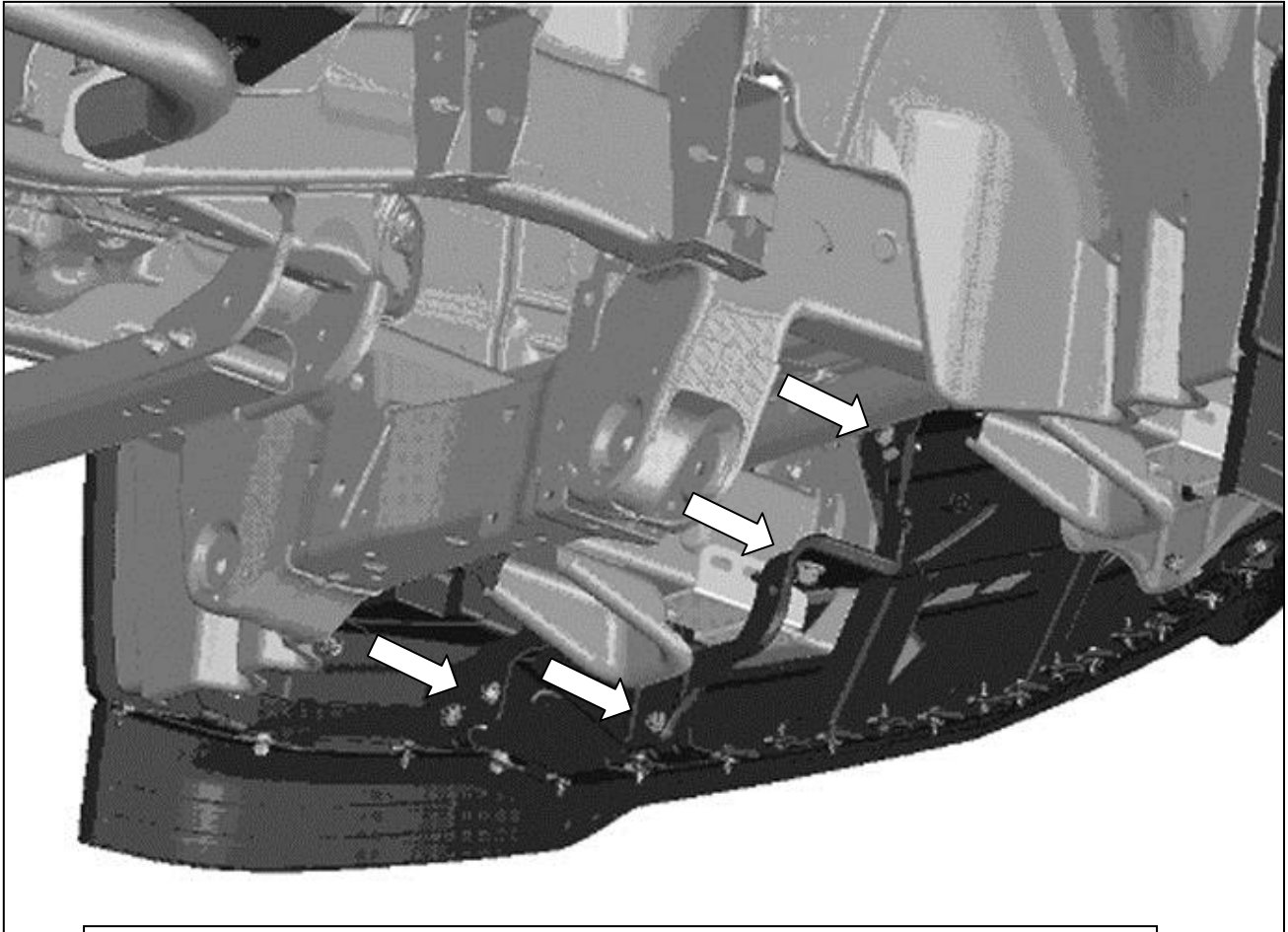

(Fig 2B) Driver side illustrated from behind bumper to show bumper bolt locations

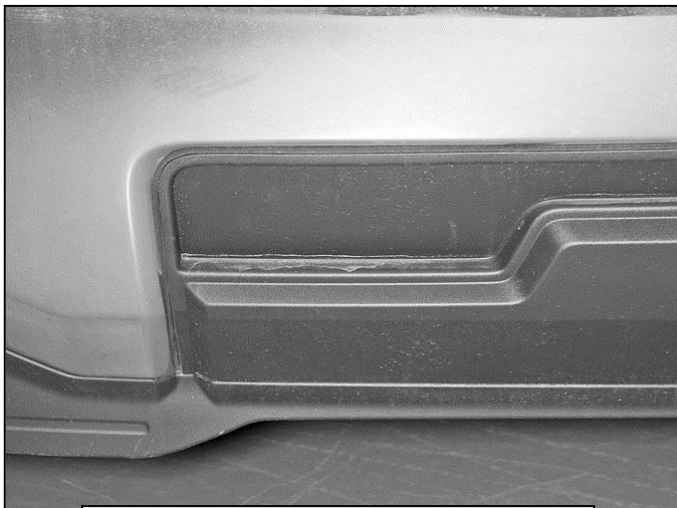

(Fig 3) "No tow hook" model pictured

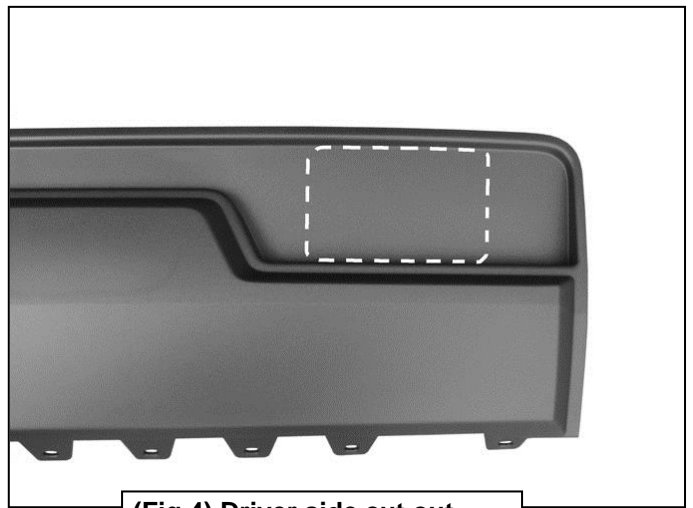

(Fig 4) Driver side cut out illustrated for reference only

Driver Side Mounting Bracket Installation Pictured

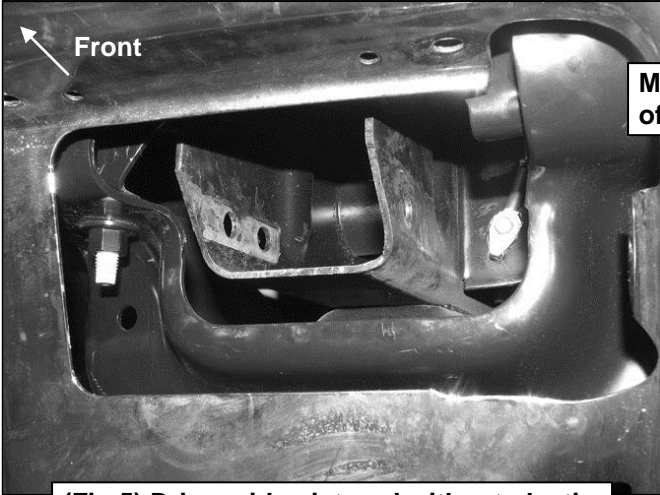

Mounting holes in end of frame for tow hook

(Fig 5) Driver side pictured without plastic panel for instruction purposes only

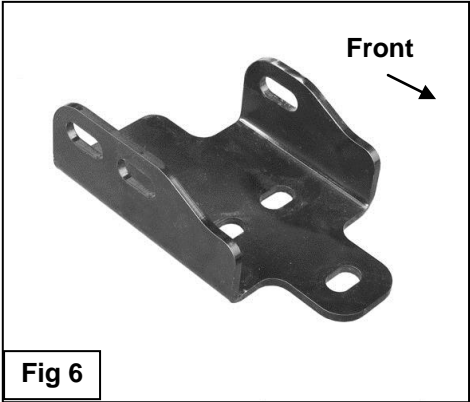

Fig 6

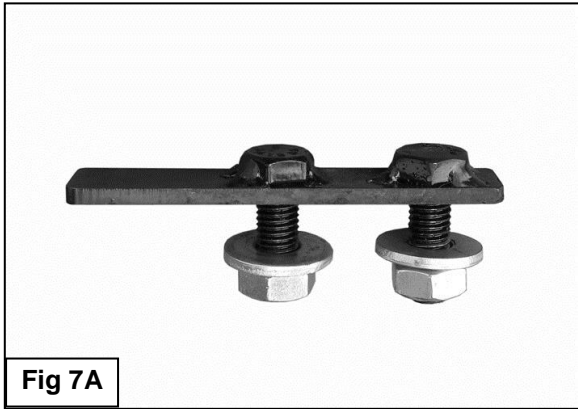

Fig 7A

- 12mm Double Bolt Plate
- (2) 12mm Flat Washers
- (2) 12mm Lock Washers
- (2) 12mm Hex Nuts

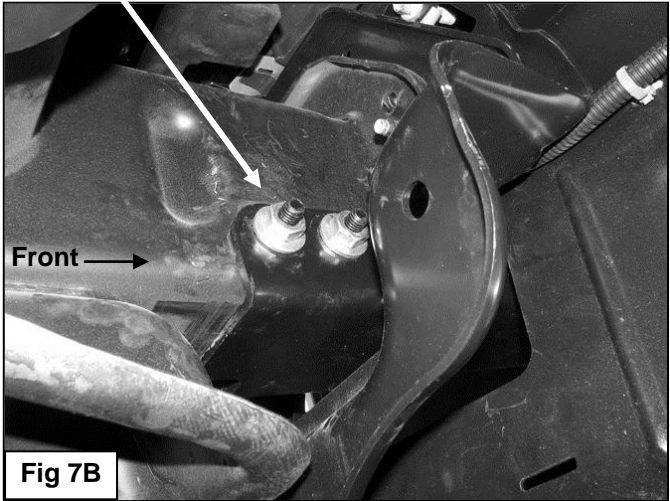

Fig 7B

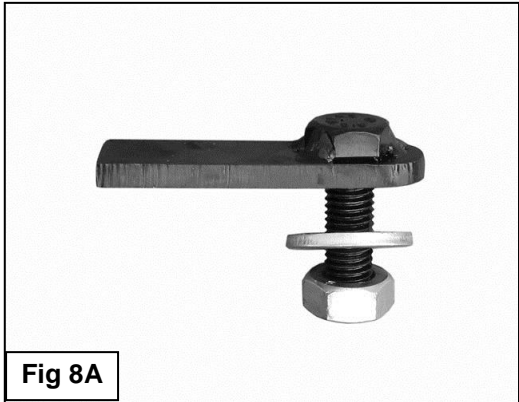
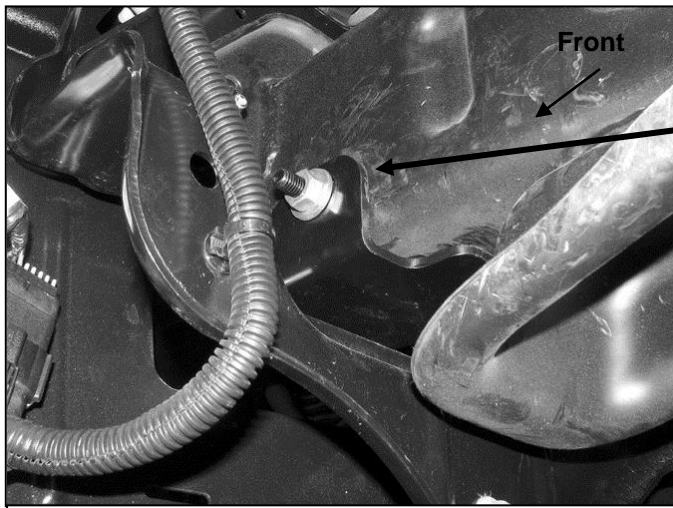

Fig 8A

Driver Side Installation Pictured



- 12mm Bolt Plate
- 12mm Flat Washer
- 12mm Lock Washer
- 12mm Hex Nut

(Fig 8B) Driver side Bracket installation pictured

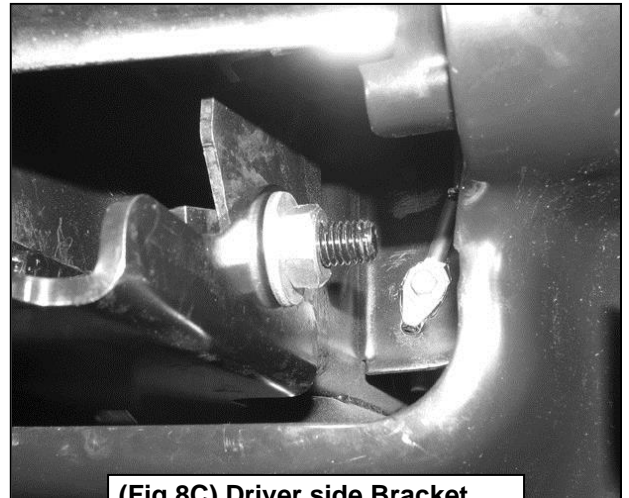

(Fig 8C) Driver side Bracket installation pictured from front

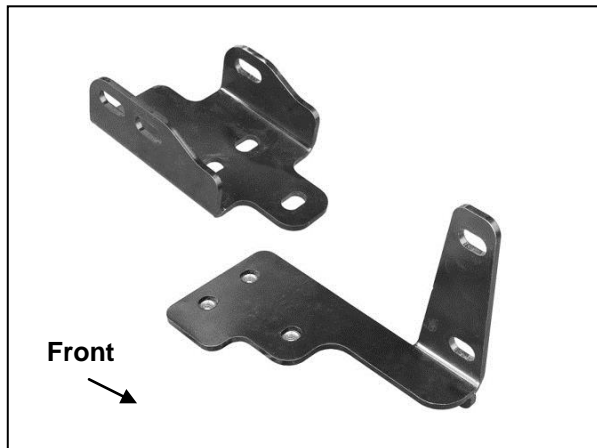

(Fig 9) Driver side Mounting Brackets pictured

- Bolt the Mounting Bracket to the bottom of the Frame Bracket with:
- (3) 8mm 30mm Hex Bolts
 - (3) 8mm Lock Washers
 - (3) 8mm Flat Washers

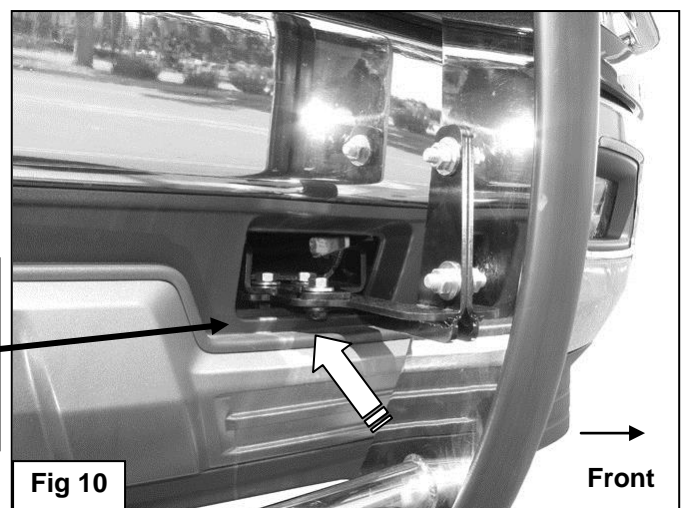
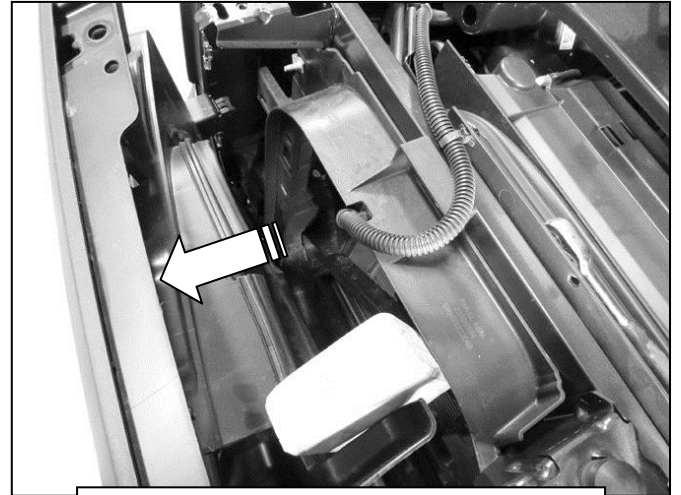

Fig 10



(Fig 11) Remove plastic cover on top of grille



(Fig 12) Tilt grille forward for access

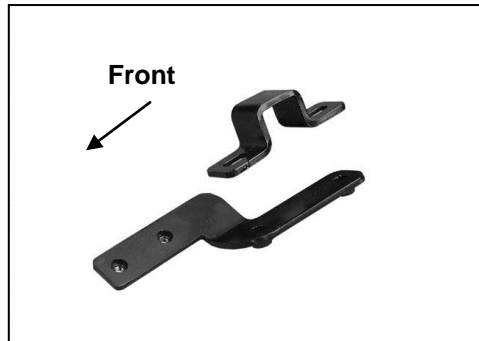

(Fig 13A) Passenger side inner Top Bracket and Backing Plate pictured

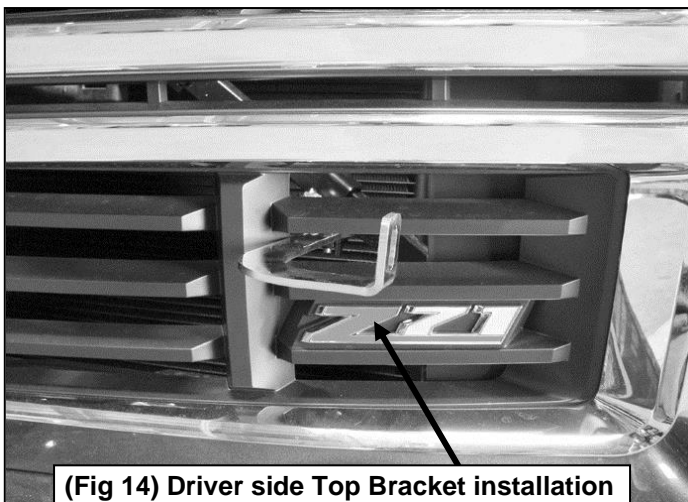

(Fig 14) Driver side Top Bracket installation pictured. Adjust position so that Bracket cannot come in contact with plastic grille

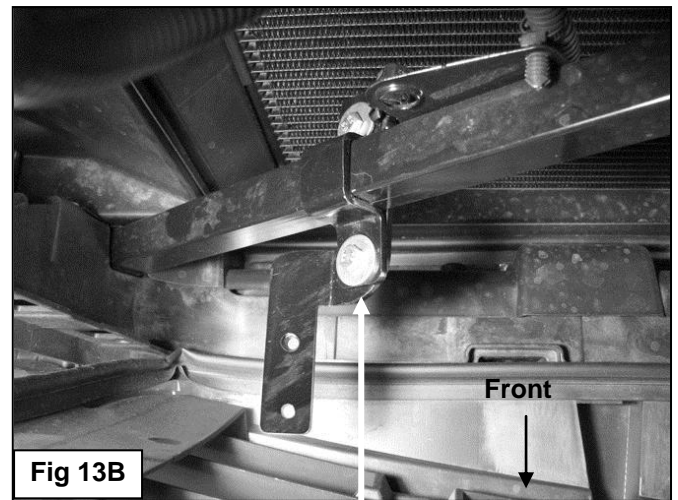
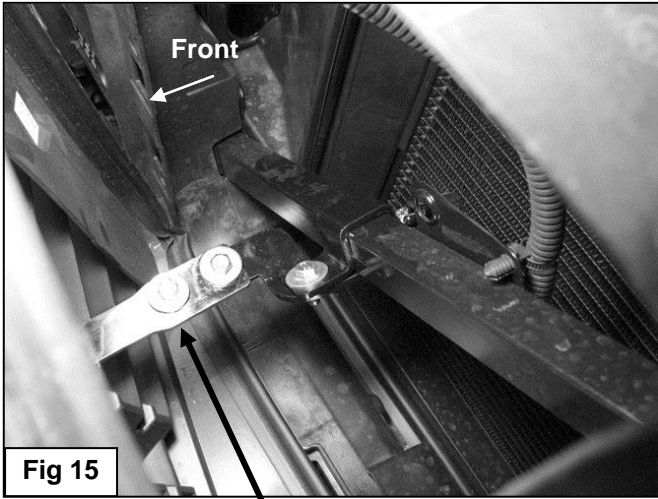

Fig 13B

Bolt the Top Inner Bracket to the Backing Plate with:
(2) 6mm x 25mm Hex Bolts
(2) 6mm Lock Washers
(2) 6mm Flat Washers



Bolt the Top Outer Bracket to the Inner Bracket with:
(2) 6mm x 25mm Hex Bolts
(2) 6mm Lock Washers
(2) 6mm Flat Washers

**6mm x 25mm Hex Bolts
6mm Lock Washers
6mm Flat Washers**

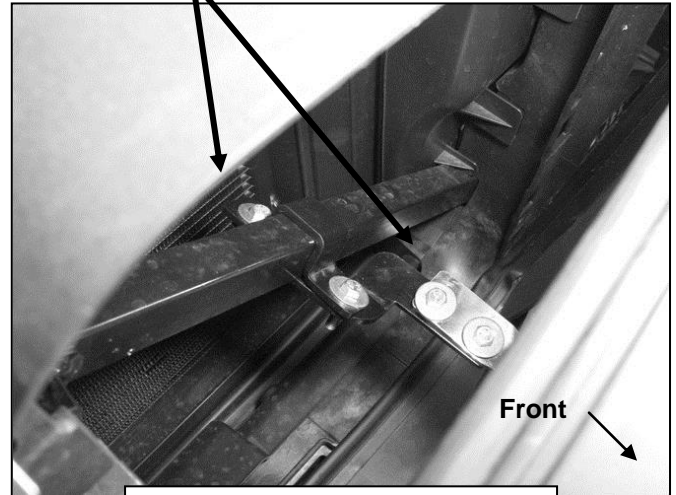

(Fig 16) Driver side Top Bracket installation pictured

**(1) 8mm Button Head Bolt
(2) 8mm Flat Washers
(1) 8mm Nylon Lock Nut**

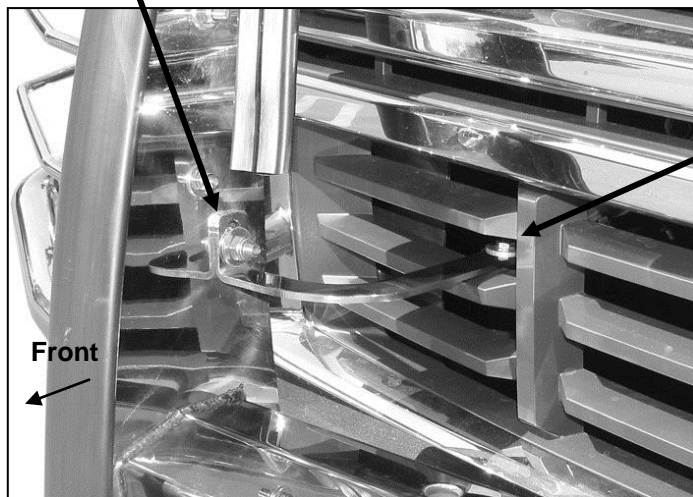

(Fig 17) Passenger side outer Top Bracket pictured

**6mm x 25mm Hex Bolts
6mm Lock Washers
6mm Flat Washers**

