

Part 200104/ 200104-2 ----PARTS LIST:

1	Driver/Left Sidebar	4	10-1.50mm x 30mm Hex Bolts
1	Passenger/Right Sidebar	8	10mm x 30mm OD x 2.5mm Flat Washers
1	Driver/Left Front Mounting Bracket	8	10mm x 20mm OD x 2mm Flat Washers
1	Passenger/Right Front Mounting Bracket	10	10mm Lock Washers
1	Driver/Left Rear Mounting Bracket	10	10mm Hex Nuts
1	Passenger/Right Rear Mounting Bracket	8	8-1.25mm x 25mm Hex Bolts
1	Driver/Left Rear Support Bracket	10	8mm x 24mm OD x 2mm Flat Washers
1	Passenger/Right Rear Support Bracket	10	8mm Lock Washers
2	10-1.50mm x 30mm Rounded Bolt Plates	2	8mm Hex Nuts
2	10-1.50mm x 40mm T-Bolt Plates	2	6-1.0mm x 25mm Hex Bolts
2	10-1.50mm x 40mm Bolt Plates	2	6mm x 18mm OD x 1.6mm Flat Washers
1	8-1.25mm x 30mm Driver Side Rod Bolt	2	6mm Lock Washers
1	8-1.25mm x 30mm Passenger Side Rod Bolt		

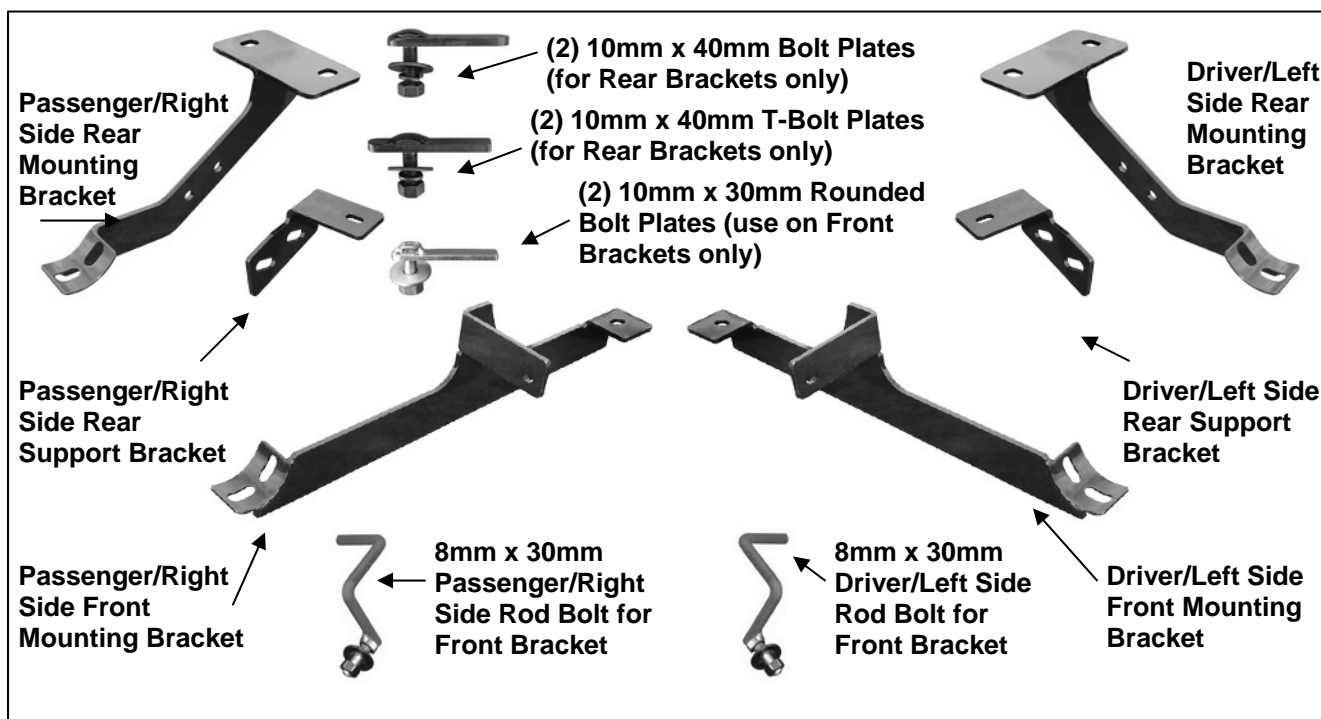

PROCEDURE:

- 1. REMOVE CONTENTS FROM BOX. VERIFY ALL PARTS ARE PRESENT. READ INSTRUCTIONS CAREFULLY BEFORE STARTING INSTALLATION.**
- Starting at the front, driver side of the vehicle, locate the round hole in the backside of the body panel, **(Figure 1)**. **NOTE:** The hole will be covered by sealing tape and undercoating. Use a small screwdriver to locate and remove the tape.
- Remove the rubber plug covering the hole in the bottom of the body panel next to the pinch weld, **(Figure 2)**. Insert the driver side 8mm x 30mm Rod Bolt into the large hole in the bottom of the body panel and out the smaller hole in the backside of the body panel identified in Step 2, **(Figure 3)**.
- Next, locate the oval slot in the bottom of the inner frame channel, **(Figure 4A)**. Insert (1) 10mm x 30mm Rounded Bolt Plate into the frame channel, **(Figure 4B)**. Select the driver side Front Frame Bracket. Hang the bracket from the 8mm Rod Bolt with (1) 8mm Flat Washer, (1) 8mm Lock Washer

and (1) 8mm Hex Nut, **(Figure 3)**. Secure the Bracket to the Rounded Bolt Plate with the supplied (1) 10mm x 30mm x 2.5mm Large Flat Washer, (1) 10mm Lock Washer and (1) 10mm Hex Nut, **(Figure 5)**. Snug but do not tighten hardware at this time.

5. Moving toward the rear of the vehicle, remove the factory 6mm hex bolt securing the plastic cover to the floor channel, **(Figure 6)**. Remove the rubber plugs covering the round and oval holes in the floor panel pictured in **Figure 6**. Insert (1) 10mm Bolt Plate into the round opening. Insert (1) 10mm T-Bolt Plate into the oval opening, **(Figure 7)**. **IMPORTANT:** Rotate T-Bolt Plate 90-degrees to the direction of the oval opening.
6. Position the driver side Rear Frame Bracket up to the vehicle and partially attach the Bracket to the (2) Bolt Plates inserted into the body panel. Secure using the included (2) 10mm x 30mm Large OD Flat Washers, (2) 10mm Lock Washers and (2) 10mm Hex Nuts, **(Figure 8)**. Snug but do not tighten hardware at this time.
7. Select the Passenger Side Rear Support Bracket. Hold the Bracket up to the threaded hole in the floor channel and insert the included (1) 6mm x 25mm Hex Bolt with (1) 6mm Lock Washer and (1) 6mm Flat Washer through the plastic cover, the Support Bracket and into the floor channel, **(Figure 9)**. Do not tighten hardware at this time.
8. Line the mounting surface on the Support Bracket with the (2) holes in the Rear Mounting Bracket. Bolt the Support Bracket to the Mounting Bracket with the included (2) 10mm x 30mm Hex Bolts, (4) 10mm x 20mm STD OD Flat Washers, (2) 10mm Lock Washers and (2) 10mm Hex Nuts, **(Figure 10)**. Snug but do not tighten hardware at this time.
9. Carefully position the driver Sidebar up to Mounting Brackets and attach it using the included (4) 8mm x 25mm Hex Bolts, (4) 8mm Flat Washers and (4) 8mm Lock Washers, **(Figure 10)**. Do not tighten hardware at this time.
10. Level and adjust Sidebar properly and tighten all hardware.
11. Repeat steps 2 - 10 for passenger Sidebar installation.
12. Do periodic inspections of the installation to make sure that all hardware is secure and tight.

To protect your investment, wax this product after installing. Regular waxing is recommended to add a protective layer over the finish. Do not use any type of polish or wax that may contain abrasives that could damage the finish.

For stainless steel: Aluminum polish may be used to polish small scratches and scuffs on the finish. Mild soap may be used also to clean the Sidebar.

For gloss black finishes: Mild soap may be used to clean the Sidebar.

Driver Side Installation Pictured

Use a small screwdriver to remove sealant tape covering small 8mm hole in backside of body panel

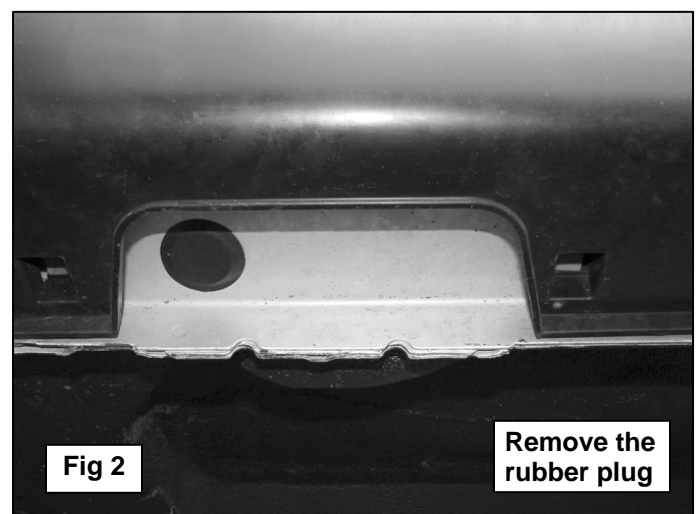
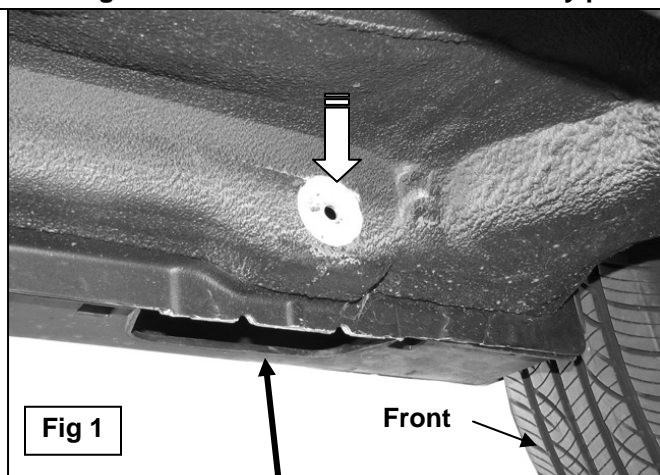

Driver Side Installation Pictured

8mm Rod Bolt
8mm Flat Washer
8mm Lock Washer
8mm Hex Nut

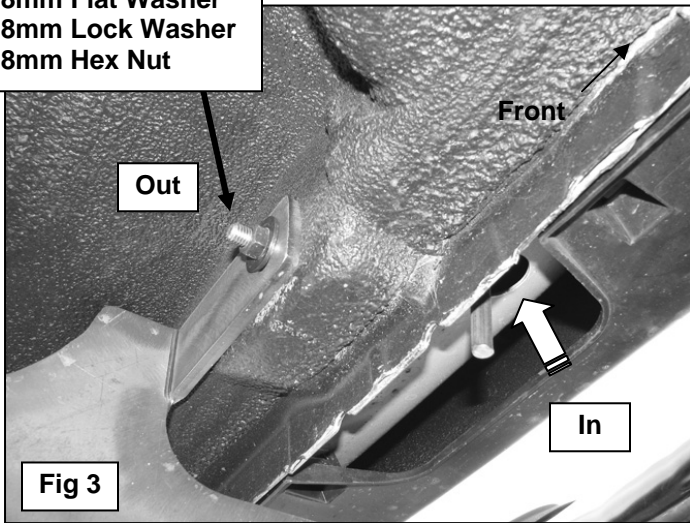

Insert 8mm x 30mm Rod Bolt into large round hole in bottom of body panel and out smaller hole in backside of body panel, (Pictured from below vehicle)

10mm x 30mm
Rounded Bolt Plate

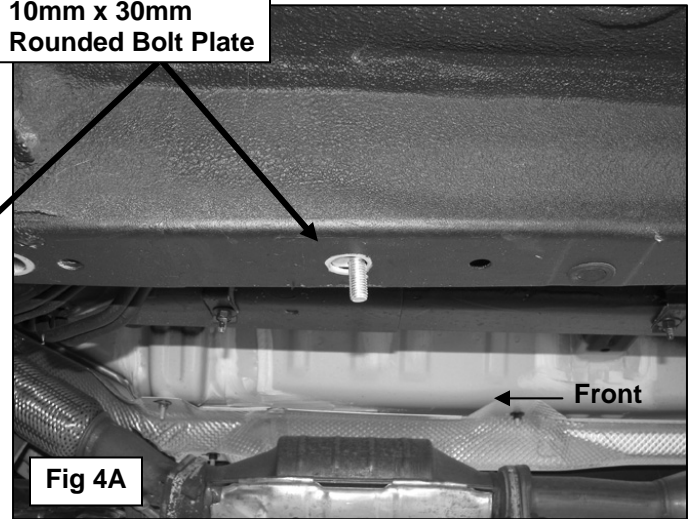

10mm x 30mm
Rounded Bolt Plate
10mm x 30mm Large
OD Flat Washer
10mm Lock Washer
10mm Hex Nut

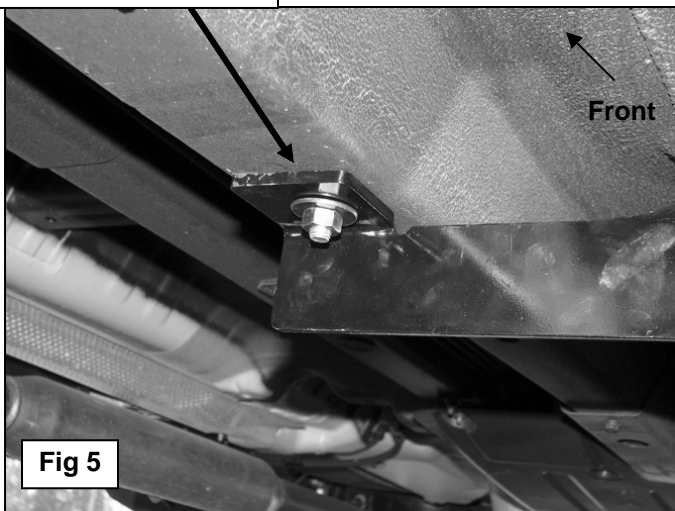
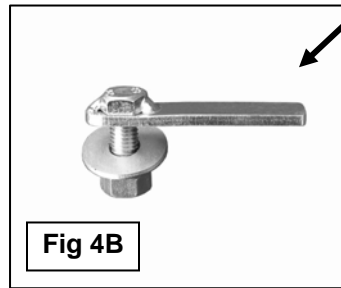

Remove 6mm hex
bolt holding plastic
cover in place

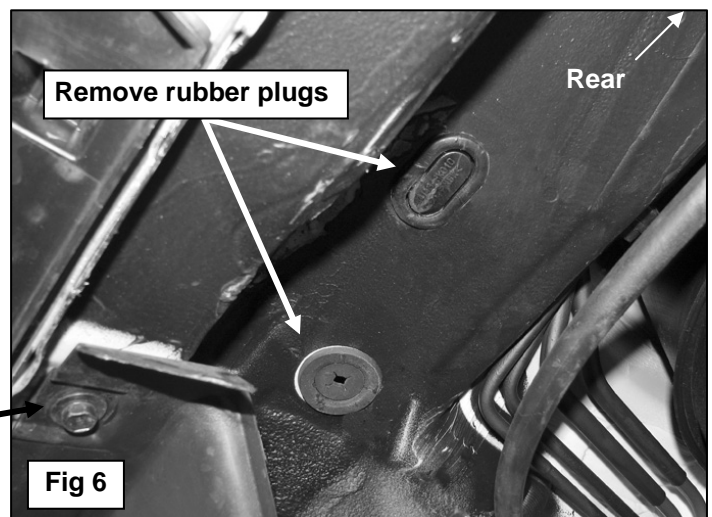

Driver Side Installation Pictured

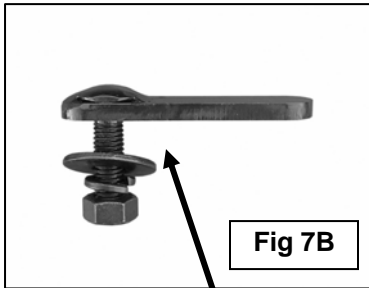

10mm x 40mm Bolt Plate

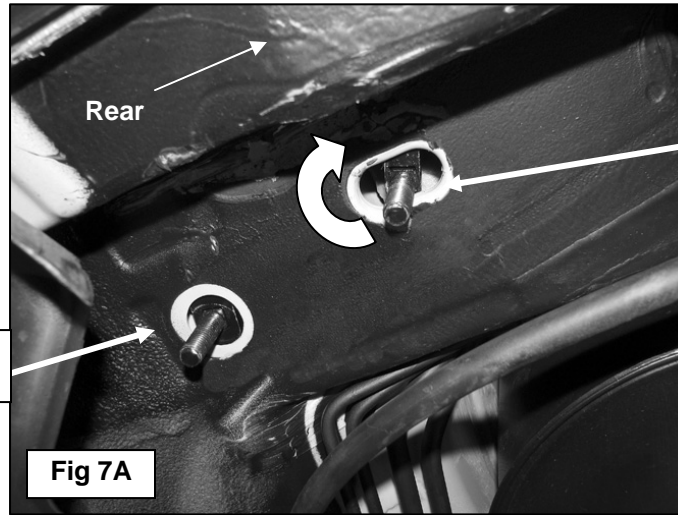

10mm x 40mm T-Bolt Plate
Insert T-Bolt Plate into opening and rotate 90-degrees to direction of slot

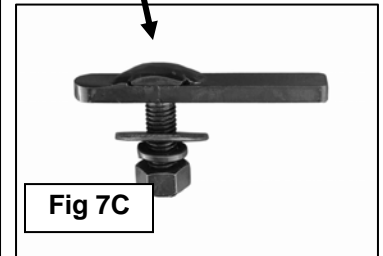

- (2) 10mm x 30mm Large OD Flat Washers
- (2) 10mm Lock Washers
- (2) 10mm Hex Nuts

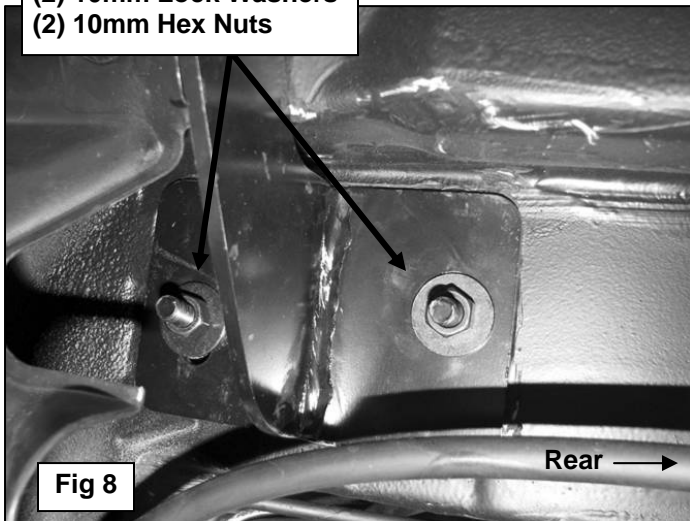

- 6mm x 25mm Hex Bolt
- 6mm Lock Washer
- 6mm Flat Washer

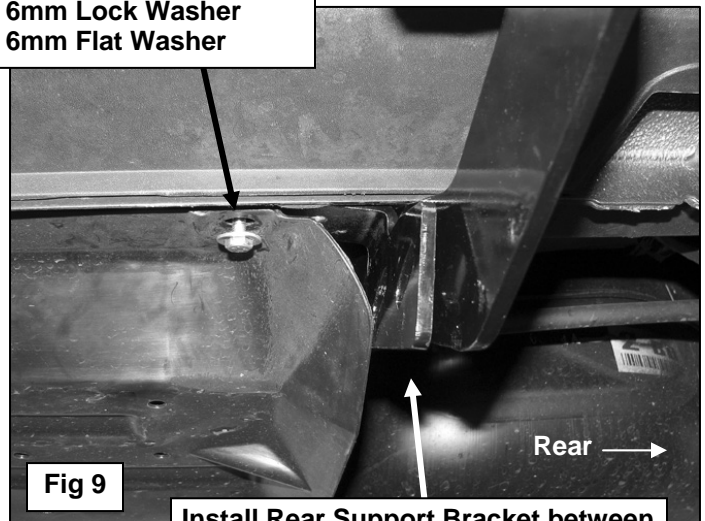

Install Rear Support Bracket between plastic cover and frame channel

- (2) 10mm Hex Bolts
- (2) 10mm Lock Washers
- (4) 10mm x 20mm OD STD Flat Washers
- (2) 10mm Hex Nuts

- Sidebar to Bracket:
- (2) 8mm x 25mm Hex Bolts
 - (2) 8mm Lock Washers
 - (2) 8mm Flat Washers

