

# AIR LIFT 1000

MULTIPLE APPLICATIONS - SEE SPECIAL NOTES  
FOR YOUR PARTICULAR VEHICLE.

BY



MN-71  
(15612)  
ECN1979

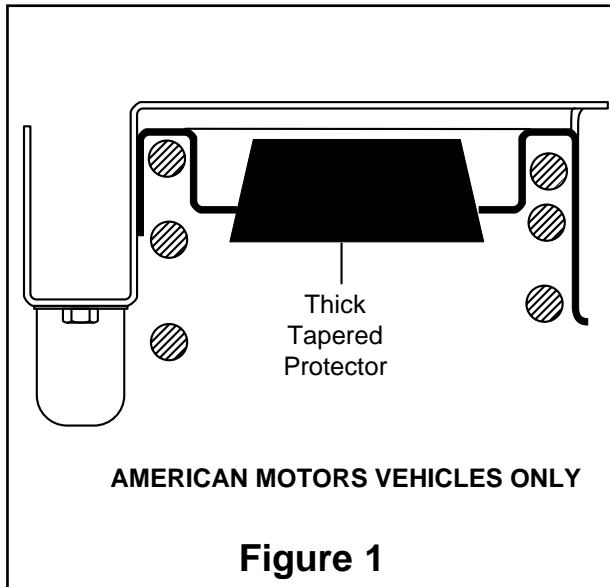

1. Air cylinders are shipped in the "as molded" shape. For ease of installation, remove plastic cap from barbed stem on end of cylinder. Push on air cylinder to exhaust as much air as possible. Replace cap on stem to maintain flat shape.
2. Lower axle or raise body of vehicle until suspension is fully extended. If necessary, additional clearance between the coil may be obtained by removing the shock absorbers from the lower shock mountings and lowering the suspension an additional one to two inches (CAUTION: OBSERVE TENSION ON BRAKE HOSE DO NOT STRAIN).

## MITSUBISHI MONTERO APPLICATION:

**NOTE: The thick tapered protector is not used for this application.**

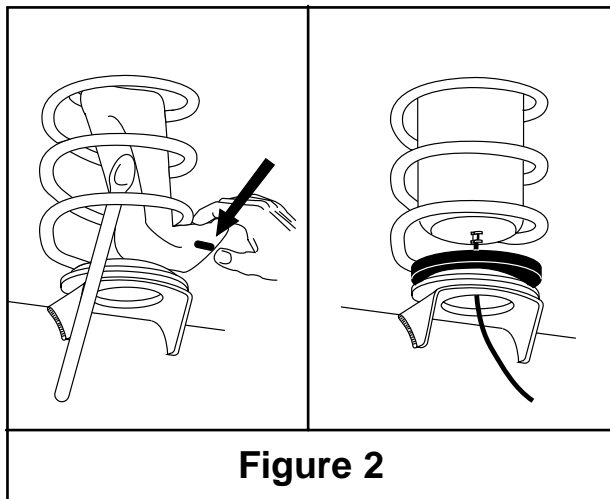

- A. Insert flattened air cylinder into lowest coil opening with stem towards the top (Figure 3). Push the cylinder up within the coil by hand or with a BLUNT instrument such as a spoon-type tire iron.
- B. When the cylinder is completely within the coil, remove the cap and allow the cylinder to assume its "as molded" shape.
- C. Push cylinder to the bottom of the coil spring. Insert the 1/2" thick protector on top of the air cylinder through coil opening and center over the barbed stem (Figure 3).

## AMERICAN MOTORS APPLICATION

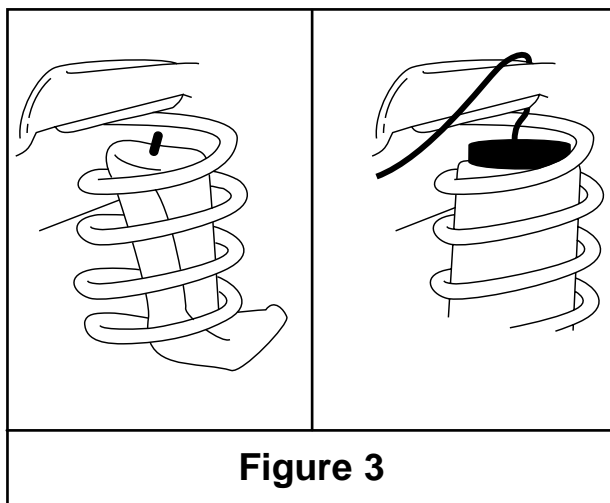

- A. Install the thick tapered protector into the hole in the upper spring seat (Figure 1).
- B. Insert flattened air cylinder into lowest coil opening with stem at the bottom (Figure 2). Push the cylinder up within the coil by hand or with a BLUNT instrument such as a spoon-type tire iron.
- C. When the cylinder is completely within the coil, remove the cap and allow the cylinder to assume its "as molded" shape.
- D. Push cylinder to the top of the coil spring. Insert lower protector through coil opening and center on axle spring seat (Figure 2).

3. Determine air line routing. A tee air line installation is recommended unless weight in vehicle varies from one side to the other and unequal pressures are needed to level load (or compensate for axle torque transfer in racing applications). Dual air lines are used in this case.

### AIR LINE INSTRUCTIONS

**CAUTION: LEAVE SUFFICIENT AIR LINE SLACK TO PREVENT ANY STRAIN ON FITTINGS DURING AXLE MOTIONS.**

**TO PREVENT AIR LINE FROM MELTING, KEEP IT AT LEAST TWELVE INCHES FROM EXHAUST SYSTEM, ENGINE AND HEAT SOURCES. CAUTION: AVOID AREAS WHICH MAY CAUSE FAILURE OF THE AIR LINE. FOR EXAMPLE: BATTERY, EXHAUST, ENGINE, AND MOVING PARTS SUCH AS STEERING, SUSPENSION AND CABLES.**

### TEE AIR LINE CONNECTION:

- A. Find desired tee location on the frame rail or radiator core support bracket (Figure 4).
- B. Determine and cut adequate length of air line to reach from tee to left and right side on air cylinders.
- C. Connect the air line to the two opposite legs on the tee (Figure 6).
- D. Route air line to left and right air springs, generally along inner fender panel or frame rails.
- E. Slide a air line clamp onto the air line. Push the air line over the barbed end of straight fitting. Compress the ears on the air line clamp with pliers and slide it down to cover the barbed section (Figure 6). Repeat for other side.
- F. Connect the straight fitting to the right & left air springs and tighten securely.
- G. Select a location for inflation valve in the hood release, front bumper, fender flange or behind the license plate, ensuring that the valve will be protected and accessible with an air hose.
- H. Connect the remaining air line over the last fitting on tee and route along frame to desired inflation valve location. Attach air line to chassis with plastic straps or wire.
- I. Drill a 5/16" hole for inflation valve and mount as illustrated (Rubber washer is for outside weather seal (Figure 7)).
- J. Connect the air line to the inflation valve.
- K. Continue with step 4.

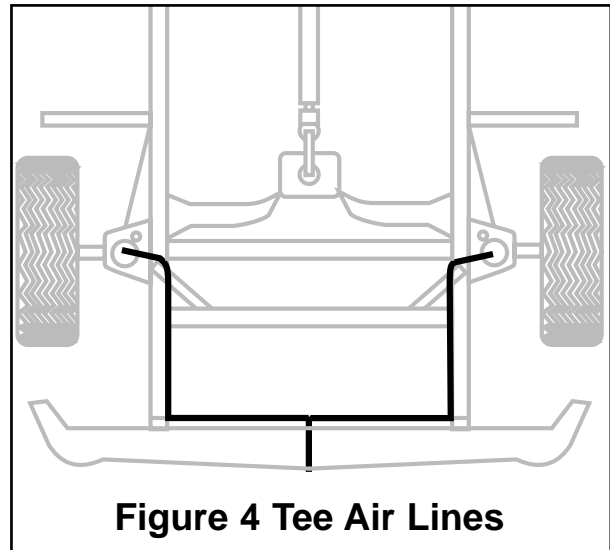

**Figure 4 Tee Air Lines**

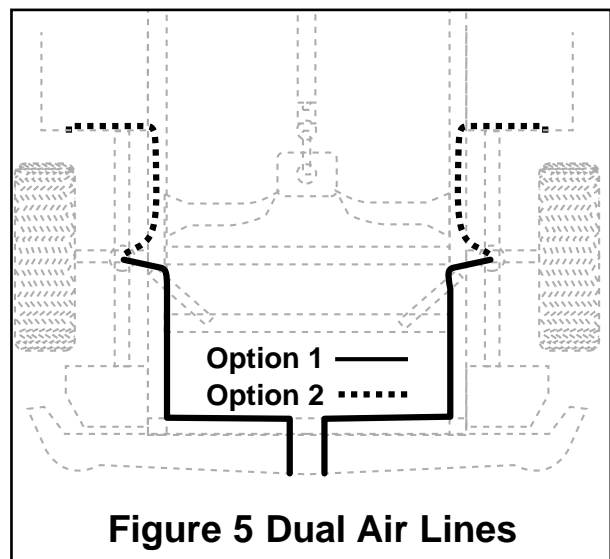

**Figure 5 Dual Air Lines**

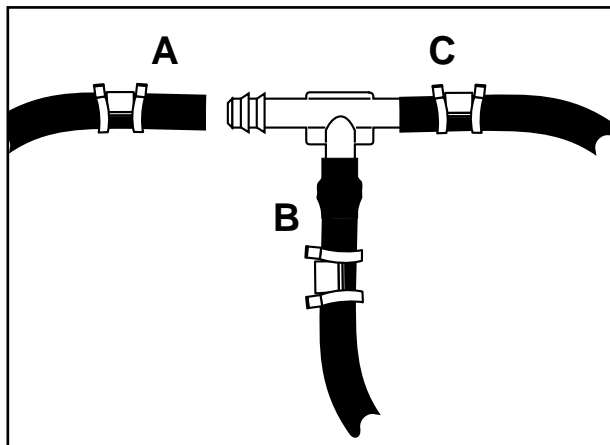

**Use this procedure for all air line connections:**  
**A. Slide air line clamp onto the air line**  
**B. Push the air line over the barbed stem.**  
**C. Compress the ears on the air line clamp with pliers and slide it forward to fully cover the barbed section.**  
**Figure 6**

**DUAL AIR LINE CONNECTION:**

- A. Select a location for the inflation valves in the rocker panel flange or by hood release ensuring that each valve will be protected and accessible with an air hose.
- B. Determine and cut adequate length, not longer than 90" of air line to reach from valve location to left side air cylinder.
- C. Slide air line clamp onto the air line. Push the air line over the barbed end of straight fitting. Compress the ears on the air line clamp with pliers and slide it down to cover the barbed section (Figure 6). Repeat for other side.
- D. Connect the straight fitting to the right & left air springs and tighten securely.
- E. Route air line along frame or under fender panel to desired inflation valve location (Figure 5). Attach air line to chassis with plastic straps or wire.
- F. Drill 5/16" hole for inflating valves and mount as illustrated (Rubber washer is for outside weather seal, Figure 7).
- G. Connect the air line to the inflation valve.
- H. Repeat process for right side.
- I. Continue with step 4.
4. Install Heat Shield kit. NOTE: Separate instructions are included with the heat shield kits.
5. Inflate Air Springs to 35 p.s.i. Check for air leaks at all fittings and valve core with a soapy water solution).
6. Replace wheels, remove safety stands and carefully lower vehicle to ground. Check to ensure cylinder is properly seated in coil spring.
7. Deflate Air Springs in 5 p.s.i. intervals to determine best ride and handing. Sufficient air pressure should be maintained to help prevent bottoming-out on large bumps, chuck holes, ect
8. Recheck air pressure after 24 hours. A 2-4 p.s.i. loss is normal after initial installation. If the pressure has dropped more than 5 p.s.i. re-test for leaks with a soapy water solution. Please read and follow the Maintenance and Operation Tips on page 4.

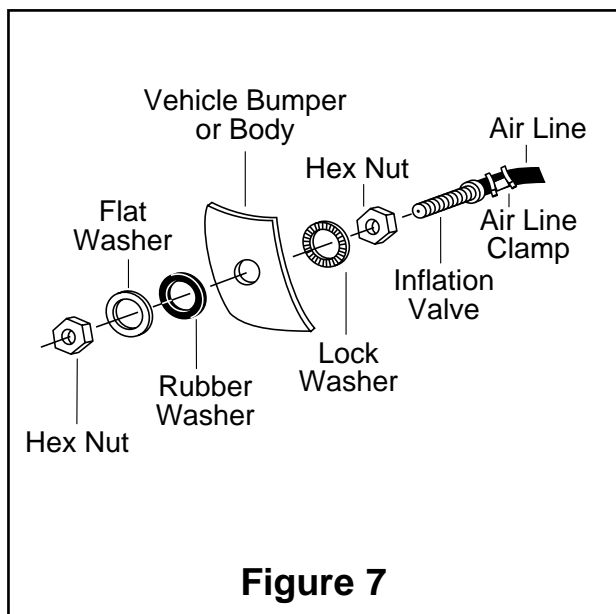

**Figure 7**

**FAILURE TO MAINTAIN MINIMUM PRESSURE WILL VOID THE WARRANTY**

<b>MINIMUM AIR PRESSURE 5 P.S.I.</b>	<b>MAXIMUM AIR PRESSURE 35 P.S.I.</b>
<p><b>MAINTENANCE TIPS:</b></p> <ol style="list-style-type: none"><li>1. Check pressure weekly!</li><li>2. Always maintain at least 5 p.s.i. air pressure to prevent chafing or coil pinch.</li><li>3. If you develop an air leak in the system, use a soapy solution to check all air line connections and the valve core before removing cylinder.</li></ol> <p><b>OPERATING TIPS:</b></p> <ol style="list-style-type: none"><li>1. Inflate your air springs to 35 p.s.i. before adding the payload. After vehicle is loaded, adjust your air pressure (down) to level the vehicle and for ride comfort.</li><li>2. When you are carrying a payload it will be helpful to increase the tire inflation pressure in proportion to any overload condition. We recommend a 2 p.s.i. increase above normal (not to exceed tire manufacturers maximum) for each 100 lbs.additional load on the axle.</li></ol>	
	<p><i>Thank you for purchasing Air Lift Products</i></p> <p><b>AIR LIFT COMPANY</b> P.O. BOX 80167 Lansing, MI 48908-0167</p>
<p><b>FOR TECHNICAL ASSISTANCE CALL 1-800-248-0892</b></p>	
<p><b>Caution: DO NOT EXCEED THE VEHICLE MANUFACTURERS MAXIMUM GROSS VEHICLE WEIGHT RATING.</b></p>	