

7929 Lincoln Ave. Riverside, CA 92504
Phone: 951.689.ICON | Fax: 951.689.1016

PART #	DESCRIPTION
57826EP	05-UP TACOMA RXT REAR 2.5 RR CDEV PAIR

COMPONENTS INCLUDED	
(2) 154885EC 05-UP TACO RXT REAR 2.5 VS CDEV (2) 250003 RESERVOIR MOUNTING PLATE (2) 605131 3/8" SPLIT LOCK WASHER	(2) 605144 3/8-12 X .750 SELF TAP BOLT (2) 611008 RXT HEAVY DUTY STEM BUSHING KIT (1) 611051 HOSE CLAMP KIT
HARDWARE INCLUDED	
611008 STEM BUSHING KIT	
(2) HEAVY DUTY 9/16" ID STEM BUSHING (2) HEAVY DUTY 9/16" ID STEM WASHER	(2) M12-1.25 JAM NUT
ADDITIONAL COMPONENTS	
(1) 255604-18 18-FT WIRE	(1) 255604-22 22-FT WIRE
TOOLS REQUIRED	
JACK JACK STANDS DRILL 11/32" DRILL BIT CENTER PUNCH	TORQUE WRENCH 5/16" SOCKET / WRENCH 9/16" SOCKET / WRENCH 17MM SOCKET / WRENCH 19MM SOCKET / WRENCH
TECH NOTES	
<p>1. INTENDED FOR USE WITH ICON RXT LEAF SPRINGS (#158505) ONLY.</p> <p>2. YOUR ICON SHOCK ASSEMBLIES COME FACTORY CHARGED TO 150 PSI. RELEASING NITROGEN PRESSURE MAY LEAD TO SHOCK MALFUNCTION AND REDUCED RIDE QUALITY. FAILURE CAUSED BY LOW NITROGEN PRESSURE IS NOT COVERED UNDER ICON'S WARRANTY POLICY.</p> <p>3. INSTALL STEM BUSHINGS AND HARDWARE AS SHOWN IN THE DIAGRAM. FAILURE CAUSED BY INCORRECT INSTALLATION OF STEM BUSHINGS AND HARDWARE IS NOT COVERED UNDER ICON'S WARRANTY POLICY.</p> <p>4. WIRE LENGTHS MEASURED FOR 3.5L CREW CAB SHORT BED.</p>	



WARNING!
<p>** READ ALL INSTRUCTIONS THOROUGHLY FROM START TO FINISH BEFORE BEGINNING INSTALLATION! IF THESE INSTRUCTIONS ARE NOT PROPERLY FOLLOWED SEVERE FRAME, SUSPENSION AND TIRE DAMAGE MAY RESULT TO THE VEHICLE!</p> <p>** ICON VEHICLE DYNAMICS RECOMMENDS THAT YOU EXERCISE EXTREME CAUTION WHEN WORKING UNDER A VEHICLE THAT IS SUPPORTED WITH JACK STANDS.</p> <p>** ICON VEHICLE DYNAMICS RECOMMENDS ALL INSTALLATION TO BE PERFORMED BY A PROFESSIONAL SHOP/SERVICE TECHNICIAN. PRODUCT FAILURE CAUSED BY IMPROPER INSTALLATION WILL NOT BE COVERED UNDER ICON'S WARRANTY POLICY.</p>

INSTALLATION

- Using a properly rated jack, raise the rear of the vehicle and support the frame rails with jack stands. Ensure the jack stands are secure and set properly before lowering the jack. NEVER WORK UNDER AN UNSUPPORTED VEHICLE. Remove the rear wheels.
- Remove the factory shock using two 17mm socket/wrenches.
- Install the RXT shock using the factory lower bolt on the lower shock mount and the supplied bushing kit for the upper stem mount. Install stem bushings and hardware as shown in the diagram: Install the lower nut and fasten until there are enough exposed threads available to secure the upper jam nut. Install jam nut until it is flush with the top of the stem (DO NOT OVERTIGHTEN) and torque to 50 ft-lbs while holding the lower nut with a 19mm wrench. Do not overtighten bushing assembly, as this can lead to shock stem failure. Failure caused by incorrect installation of stem bushings and hardware is NOT covered under ICON's warranty policy.

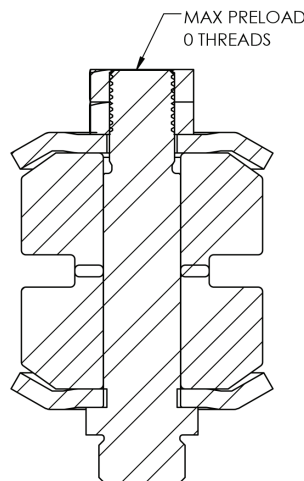

- Mount the reservoir to the reservoir bracket using the supplied hose clamps and a 5/16" nut driver. Make sure that the hose clamps line up with the machined grooves on the reservoir surface.

5. Hold the reservoir against the frame with a small amount of slack in the hose. Mark the location on the frame of the mounting hole of the reservoir bracket. [FIGURE 1]

FIG.1



6. Remove the reservoir bracket from the reservoir.

7. Center punch the hole location previously marked and then drill an 11/32" hole in the frame. Be careful not to drill through any lines or wires running inside of the frame channel.

8. Thread the holes using the supplied 3/8" self tapping bolts (605144) and a 9/16" socket.

9. Fasten the reservoir bracket to the frame using the self tapping bolts & split washer (605144 & 605131).

10. Mount the reservoir to the bracket using a 5/16" nut driver. Make sure that the hose clamps line up with the machined grooves on the reservoir surface.

11. Install the wheels and lower the vehicle back to the ground. [Torque lugs to factory spec]

12. Refer to IIC install instructions for wire installation.

VERIFY ALL FASTENERS ARE PROPERLY TORQUED BEFORE DRIVING VEHICLE.

RETORQUE ALL NUTS, BOLTS AND LUGS AFTER 100 MILES AND PERIODICALLY THEREAFTER.



2.5 VS SERIES SHOCK & COILOVER TECHNICAL INFORMATION

MAINTENANCE

ICON shock absorbers are a high quality rebuildable race style shock absorber designed for optimal performance. With a unit of this caliber on your vehicle, routine maintenance is required to keep them looking and operating in like new condition. Residual oil and assembly lube may be present at all seal paths from the factory out of the box and is considered normal. Pooling of oil however is not acceptable at any time and one should contact the ICON dealer where purchased.

BELOW ARE GUIDELINES BASED ON HOW YOU USE YOUR VEHICLE BUT YOUR MILEAGE MAY VARY:

STREET USE:

- Send in for factory servicing every 40,000 miles or if a leak develops, ride quality decreases, or they begin to make excessive noise.
- Remove any buildup of road salt, mud, or debris from shocks and coil springs anytime accrued
- Clean with mild soap and water with each oil change or anytime you notice build up.
- Wax the cylinders yearly with automotive wax to prevent corrosion.
- Check nitrogen pressure yearly. (252004 charge needle assembly available at any ICON distributor)
- Check bearings for excessive wear yearly.
- DO NOT apply any type of lube to the upper and lower bearings.

STREET/DIRT:

- Send in for factory servicing every 15,000 miles or if a leak develops, ride quality decreases, or they begin to make excessive noise.
- Clean with mild soap and water with each oil change, offroad trip, or anytime you notice build up.
- Wax the cylinders yearly with automotive wax to prevent corrosion.
- Check nitrogen pressure each dirt outing. (252004 charge needle assembly available at any ICON distributor)
- Check bearings for excessive wear yearly.
- DO NOT apply any type of lube to the upper and lower bearings.

DIRT USE:

- Send in for factory servicing every 1,000 miles.
- Check nitrogen pressure each outing. (252004 charge needle assembly available at any ICON distributor)
- Remove any buildup of mud or debris from shocks and coil springs after every outing.

SELF-SERVICE:

- Contact ICON for service kits & tools at (951) 689-4266.

PRODUCT REGISTRATION

Please visit: <http://www.iconvehicledynamics.com/tech-support/registration/> to register your product.

ICON VEHICLE DYNAMICS SHOCK ABSORBER WARRANTY

This shock absorber has a 1 year warranty against any manufacturer's defects. If a shock fails within the initial year of ownership, the shock must be shipped to ICON Vehicle Dynamics for inspection and service. If a shock is inspected and it has been determined the shock failed due to neglect, damage caused by improper installation or any other reason besides "normal wear and tear", the owner of said shock is responsible for all service costs. This includes labor, parts, and shipping.

ICON Vehicle Dynamics warrants to the original retail purchaser who owns the vehicle on which the product was originally installed. ICON Vehicle Dynamics does not warrant the product for finish, alterations, modifications and/or installation contrary to ICON Vehicle Dynamics instructions. ICON Vehicle Dynamics products are not designed, nor are they intended to be installed on vehicles used in race applications, for racing purposes or for similar activities. (A "race" is defined as any contest between two or more vehicles, or a contest of one or more vehicles against the clock, whether or not such contest is for a prize). This warranty does not include coverage for police or taxi vehicles, race vehicles, or vehicles used for government or commercial purposes. Also excluded from this warranty are sales outside of the United States of America and Canada.

ICON Vehicle Dynamics' obligation under this warranty is limited to the repair or replacement, at ICON Vehicle Dynamics' discretion, of the defective product. Any and all costs of removal, installation or re-installation, freight charges and incidental or consequential damages are expressly excluded from this warranty. Items that are subject to wear are not considered defective when worn and are not covered.

ICON Vehicle Dynamics components must be installed as a complete kit as shown in our current application guide. Any substitutions or exemptions of required components will immediately void the warranty. Some finish damage may happen to parts during shipping and is not covered under warranty.

This warranty is expressly in lieu of all other warranties expressed or implied. This warranty shall not apply to any product that has been improperly installed, modified or customized subject to accident, negligence, abuse or misuse.

To send a shock in for warranty please visit our website <http://www.iconvehicledynamics.com/tech-support/shock-service/>



ICON VEHICLE DYNAMICS®
PERFORMANCE SUSPENSION SYSTEMS AND SHOCK ABSORBERS

7929 Lincoln Ave. Riverside, CA 92504 Phone: 951.689.ICON Fax: 951.689.1016
www.iconvehicledynamics.com



FOLLOW US ON FACEBOOK!

